

APPLICATIONS IN ENUMERATIVE COMBINATORICS OF INFINITE WEIGHTED AUTOMATA AND GRAPHS

RODRIGO DE CASTRO, ANDRÉS L. RAMÍREZ, AND JOSÉ L. RAMÍREZ

ABSTRACT. In this paper we present a general methodology to solve a wide variety of classical lattice path counting problems in an uniform way. These counting problems are related to Dyck paths, Motzkin paths and some generalizations. The methodology uses weighted automata, equations of ordinary generating functions and continued fractions. It is a variation of the technique proposed by J. Rutten, which is called Coinductive Counting.

1. INTRODUCTION

Formal languages, finite automata and grammars are basic mathematical objects in Theoretical Computer Science with remarkable applications in various fields such as Algebra, Number Theory and Combinatorics, [4, 6, 8]. In particular, by using finite automata and grammars, some combinatorial results are related to enumeration of discrete objects and their generating functions [5, 8, 13, 16, 18].

Combinatorics is an important branch of Mathematics which is focused on study of discrete objects. These kind of objects often arise in Theoretical Computer Science. Enumerate Combinatorics is one of the main subfield of Combinatorics and it addresses the problem how to count the number of elements of a finite set in an exact or approximate way. The finite set is given by some combinatorial conditions. Some examples of combinatorial objects are lattice paths, trees, polyominoes, words and planar maps, etc.

Several different methods exist to study combinatorial objects. For example, the symbolic enumeration method [13], the transfer-matrix method [14], the Schützenberger methodology also called

Delest-Viennot-Schützenberger methodology [5] and coinductive counting [20]. The last methodology uses infinite weighted automata, stream bisimulation and stream calculus.

An infinite weighted automaton is a generalization of a nondeterministic weighted finite automaton. Its transitions carry weights. These weights may model, e.g., the cost involved when executing a transition, or the probability or reliability of its successful execution [11]. Some restricted relations between infinite weighted automata and combinatorics have been developed in [17, 20, 27, 26]; however, there are few studies in this direction.

In this paper we present a variation of the methodology developed by J. Rutten in [20], without the use of coinduction. We use only infinite weighted automata, weighted graphs and continued fractions. We develop a set of properties which allow us to find the associated ordinary generating function by solving systems of equations. It is possible to derive existing and new counting results from this new perspective. Specifically, we apply this methodology

Date: December 30, 2013.

2010 Mathematics Subject Classification. Primary 68Q45, 05A15 ; Secondary 05A19.

Key words and phrases. Infinite Weighted Automata, Enumerative Combinatorics, Continued Fractions, Generating Functions, Lattice Paths.

in problems of lattice paths, such as Dyck paths, Riordan paths, Motzkin paths, colored Motzkin paths, generalized Motzkin paths, among others.

The outline of this paper is as follows. In Section 2 we recall the notions of weighted automata and its ordinary generating functions. In Section 3 we develop a set of properties to decide when an automaton is convergent, which are necessary to find the ordinary generating function associated with the automaton. Then in the Section 4 we describe the proposed Counting Automata Methodology. Finally, in Section 5 we find the generating function of a family of infinite weighted automata and we work out some examples of lattice paths.

2. WEIGHTED AUTOMATA AND GENERATING FUNCTIONS

The terminology and notations are mainly those of Sakarovitch [21] and Shallit [23]. Let Σ be a finite alphabet, whose elements are called *symbols*. A *word* over Σ is a finite sequence of symbols from Σ . The set of all words over Σ , i.e., the free monoid generated by Σ , is denoted by Σ^* . The identity element ϵ of Σ^* is called the *empty word*. For any word $w \in \Sigma^*$, $|w|$ denotes its *length*, i.e., the number of symbols occurring in w . The length of ϵ is taken to be equal to 0. If $a \in \Sigma$ and $w \in \Sigma^*$, then $|w|_a$ denotes the number of occurrences of a in w . Let Σ be a finite alphabet. Then each subset of Σ^* is called a *formal language* over Σ . The number of words of length n in a language L is denoted by $L^{(n)}$.

An *automaton* \mathcal{M} is a 5-tuple $\mathcal{M} = (\Sigma, Q, q_0, F, E)$, where Σ is a nonempty input alphabet, Q is a nonempty set of states of \mathcal{M} , $q_0 \in Q$ is the initial state of \mathcal{M} , $\emptyset \neq F \subseteq Q$ is the set of final states of \mathcal{M} and $E \subseteq Q \times \Sigma \times Q$ is the set of transitions of \mathcal{M} . The language recognized by an automaton \mathcal{M} is denoted by $L(\mathcal{M})$. If Q, Σ and E are finite sets, we say that \mathcal{M} is a finite automaton [21].

We often describe an automaton \mathcal{M} by providing a transition diagram or a labelled graph. This is a directed graph where states are represented by circles, final states by double circles, the initial state is labelled by a headless arrow entering a state, and transitions are represented by directed arrows, labelled with a symbol. Automata in this paper do not have useless states.

Example 1. Consider the finite automaton $\mathcal{M} = (\Sigma, Q, q_0, F, E)$ where $\Sigma = \{a, b\}$, $Q = \{q_0, q_1\}$, $F = \{q_0\}$ and $E = \{(q_0, a, q_1), (q_0, b, q_0), (q_1, a, q_0)\}$. The transition diagram of \mathcal{M} is as shown in Figure 1. It is easy to verify that $L(\mathcal{M}) = (b \cup aa)^*$.

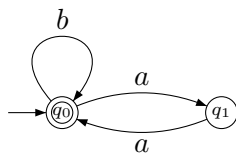

FIGURE 1. Transition diagram of \mathcal{M} , Example 1.

Example 2. Consider the infinite automaton $\mathcal{M}_{\mathcal{D}} = (\Sigma, Q, q_0, F, E)$, where $\Sigma = \{a, b\}$, $Q = \{q_0, q_1, \dots\}$, $F = \{q_0\}$ and $E = \{(q_i, a, q_{i+1}), (q_{i+1}, b, q_i) : i \in \mathbb{N}\}$. The transition diagram of $\mathcal{M}_{\mathcal{D}}$ is as shown in Figure 2.

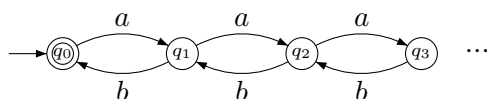

FIGURE 2. Transition Diagram of $\mathcal{M}_{\mathcal{D}}$, Example 2.

The language accepted by $\mathcal{M}_{\mathcal{D}}$ is:

$$L(\mathcal{M}_{\mathcal{D}}) = \{w \in \Sigma^* : |w|_a = |w|_b \text{ and for all prefix } v \text{ of } w, |v|_b \leq |v|_a\}.$$

This automaton is known as the Dyck Automaton [3].

2.1. Generating Function of Languages. An ordinary generating function $F = \sum_{n=0}^{\infty} f_n z^n$ corresponds to a formal language L if $f_n = |\{w \in L : |w| = n\}|$, i.e., if the n -th coefficient f_n gives the number of words in L with length n .

How to find the ordinary generating function (GF) corresponding to context-free language is known as the *Schützenberger methodology*, (see, e.g., [5, 8, 13]). If $L \subseteq \Sigma^*$ is an unambiguous context-free language, then the GF corresponding to L is algebraic over $\mathbb{Q}(x)$; moreover, if L is a regular language then the GF corresponding to L is a rational series (see, e.g., [11, 13, 21]). Let $G = (V, \Sigma, P, S)$ be an unambiguous context-free grammar of the language L_G , where V is a finite set of *nonterminal symbols*, Σ is a finite set of *terminal symbols* with $\Sigma \cap V = \emptyset$, $S \in V$ is a special symbol in V , called the *starting symbol* and P is a finite set of *rules* which, $P \subseteq V \times (V \cup \Sigma)^*$. The morphism Θ is defined by

$$\begin{aligned} \Theta(\epsilon) &= 1, \\ \Theta(a) &= z, \quad \forall a \in \Sigma, \\ \Theta(A) &= A(z), \quad \forall A \in V. \end{aligned}$$

Any production rule $A \rightarrow e_1|e_2|\dots|e_k \in P$ yields an algebraic equation in the $A(z), B(z), \dots$

$$\Theta(A) = \sum_{i=1}^{\infty} \Theta(e_i).$$

We obtain a system of equations over the unknown $A(z), B(z), \dots$. This system has to be solved for $S(z)$ and gives the generating function corresponding to L_G .

Example 3. Consider the finite automaton from Example 1. Then we obtain the following system of equations

$$\begin{cases} \mathcal{L}_0 &= \{b\} \times \mathcal{L}_0 + \{a\} \times \mathcal{L}_1 + 1 \\ \mathcal{L}_1 &= \{a\} \times \mathcal{L}_0 \end{cases}$$

This gives rise to a set of equations for the associated GFs

$$\begin{cases} L_0(z) &= zL_0(z) + zL_1(z) + 1 \\ L_1(z) &= zL_0(z) \end{cases}$$

Solving the system, we have the GF corresponding to $L(\mathcal{M})$. It is $L_0(z)$ since the initial state of the automaton is q_0 , and

$$L_0(z) = \frac{1}{1 - z - z^2} = \sum_{n=0}^{\infty} F_n z^n,$$

where F_n is the n -th Fibonacci number, see sequence A000045 ¹.

¹Many integer sequences and their properties are to be found electronically on the On-Line Encyclopedia of Sequences [25].

2.2. Formal Power Series and Weighted Automata. Given an alphabet Σ and a semiring \mathbb{K} . A *formal power series* or *formal series* S is a function $S : \Sigma^* \rightarrow \mathbb{K}$. The image of a word w under S is called the *coefficient* of w in S and is denoted by s_w . The series S is written as a formal sum $S = \sum_{w \in \Sigma^*} s_w w$. The set of formal power series over Σ with coefficients in \mathbb{K} is denoted by $\mathbb{K}\langle\langle \Sigma^* \rangle\rangle$.

An automaton over Σ^* with weight in \mathbb{K} , or \mathbb{K} -*automaton* over Σ^* is a graph labelled with elements of $\mathbb{K}\langle\langle \Sigma^* \rangle\rangle$, associated with two maps from the set of vertices to $\mathbb{K}\langle\langle \Sigma^* \rangle\rangle$. Specifically, a *weighted automaton* \mathcal{M} over Σ^* with weights in \mathbb{K} is 4-tuple $\mathcal{M} = (Q, I, E, F)$ where

- Q is a nonempty set of *states* of \mathcal{M} .
- An element E of $\mathbb{K}\langle\langle \Sigma^* \rangle\rangle^{Q \times Q}$ called *transition matrix*.
- I is an element of $\mathbb{K}\langle\langle \Sigma^* \rangle\rangle^Q$, i.e., I is a function from Q to $\mathbb{K}\langle\langle \Sigma^* \rangle\rangle$. I is the *initial function* of \mathcal{M} and can also be seen as a row vector of dimension Q , called *initial vector* of \mathcal{M} .
- F is an element of $\mathbb{K}\langle\langle \Sigma^* \rangle\rangle^Q$, i.e., F is a function from Q to $\mathbb{K}\langle\langle \Sigma^* \rangle\rangle$. F is the *final function* of \mathcal{M} and can also be seen as a column vector of dimension Q , called *final vector* of \mathcal{M} .

For more details see [11, 21].

We say that \mathcal{M} is a *counting automaton* if $\mathbb{K} = \mathbb{Z}$ and $\Sigma^* = \{z\}^*$. With each automaton, we can associate a counting automaton. It can be obtained from a given automaton replacing every transition labelled with a symbol a , $a \in \Sigma$, by a transition labelled with z . This transition is called a *counting transition* and the graph is called a *counting automaton* of \mathcal{M} .



FIGURE 3. Counting transition.

Each transition from p to q yields an equation:

$$L(p)(z) = zL(q)(z) + [p \in F] + \dots$$

We use L_p to denote $L(p)(z)$. We also use Iverson's notation, $[P] = 1$ if the proposition P is true and $[P] = 0$ if P is false.

3. CONVERGENT AUTOMATA AND CONVERGENT THEOREMS

We denote by $L^{(n)}(\mathcal{M})$ the number of words of length n recognized by the automaton \mathcal{M} , including repetitions.

Definition 4. We say that an automaton \mathcal{M} is convergent if for all integer $n \geq 0$, $L^{(n)}(\mathcal{M})$ is finite.

It is clear that every finite automaton is convergent, however, there are non convergent infinite automata.

Example 5. Let $\mathcal{M} = (\Sigma, Q, q_0, F, E)$ be an infinite automaton, where $\Sigma = \{a\}$, $Q = \{q_0, q_1, \dots\} = F$ and $E = \{(q_i, a, q_{i+1}) : i \in \mathbb{N}\}$, see Figure 4. It is clear that $L(\mathcal{M}) = \{a^n : n \geq 0\}$, then $L^{(n)}(\mathcal{M}) = 1$ for all $n \geq 1$, hence \mathcal{M} is convergent.

Example 6. Let $\mathcal{M} = (\Sigma, Q, q_0, F, E)$ be an infinite automaton, where $\Sigma = \{a_0, a_1, \dots\}$, $Q = \{q_0, q\}$, $F = \{q\}$ and $E = \{(q_0, a_i, q) : i \in \mathbb{N}\}$, see Figure 5. It is clear that $L(\mathcal{M}) = \Sigma$, which is an infinite set, then \mathcal{M} is not convergent.

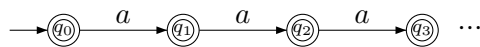
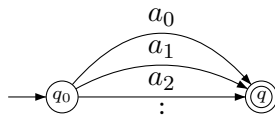
FIGURE 4. Transition diagram of \mathcal{M} , Example 5.FIGURE 5. Transition diagram of \mathcal{M} , Example 6.

Example 7. Let $\mathcal{M} = (\Sigma, Q, q_0, F, E)$ be an infinite automaton, where $\Sigma = \{a\}$, $Q = \{q_0, q_1, q_2, \dots\}$, $F = \{q_1, q_2, \dots\}$ and $E = \{(q_0, a, q_i) : i \in \mathbb{Z}^+\}$, see Figure 6. It is clear that $L(\mathcal{M}) = \{a\}$, however, $L^{(1)}(\mathcal{M})$ is infinite.

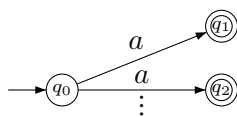
FIGURE 6. Transition diagram of \mathcal{M} , Example 7.

3.1. Criteria for Convergence.

Definition 8. Let $\mathcal{M} = (\Sigma, Q, q_0, F, E)$ be an automaton. We defined the set of states of \mathcal{M} reachable from state $q \in Q$ in n transitions, Q_n^q , recursively as follows:

$$Q_n^q = \begin{cases} \{q\}, & \text{if } n = 0; \\ \bigcup \{p' : (p, a, p') \in E, p \in Q_{n-1}^q\}, & \text{if } n \geq 1. \end{cases}$$

Theorem 9 (First Convergence Theorem). *Let \mathcal{M} be an automaton, such that each vertex (state) of the counting automaton of \mathcal{M} has finite degree. Then \mathcal{M} is convergent.*

Proof. Any path of length n in the transition diagram of \mathcal{M} can be considered as a sequence of $n + 1$ states, where each state is taken exclusively of the sets $Q_0^{q_0}, Q_1^{q_0}, Q_2^{q_0}, \dots, Q_n^{q_0}$. Since $\bigcup_{k=0}^n Q_k^{q_0}$ is a finite set, $L^{(n)}(\mathcal{M})$ is finite, because any word of length n is obtained after n choices, each with a finite number of options. \square

Example 10. The counting automaton of the automaton $\mathcal{M}_{\mathcal{D}}$ in Example 2 is convergent.

The following definition plays an important role in the development of applications because it allows to simplify counting automata whose transitions are formal series.

Let \mathcal{M} be an automaton, and let $f(z) = \sum_{n=1}^{\infty} f_n z^n$ be a formal power series with $f_n \in \mathbb{N}$ for all $n \geq 1$. In a counting automaton of \mathcal{M} the set of counting transitions from state p to state q , without intermediate final states, see Figure 7(left), is represented by a graph with a single edge labelled by $f(z)$, see Figure 7(right).

This kind of transition is called a *transition in parallel*. The states p and q are called *visible states* and the intermediate states are called *hidden states*.

Example 11. In Figure 8(left) we display a counting automaton \mathcal{M}_1 without transitions in parallel, i.e., every transition is label by z . The transitions from state q_1 to q_2 correspond to the series $\frac{1-\sqrt{1-4z}}{2} = z + z^2 + 2z^3 + 5z^4 + 14z^5 + \dots$. However, this automaton can also be represented using transitions in parallel. Figure 8(right) displays two examples.

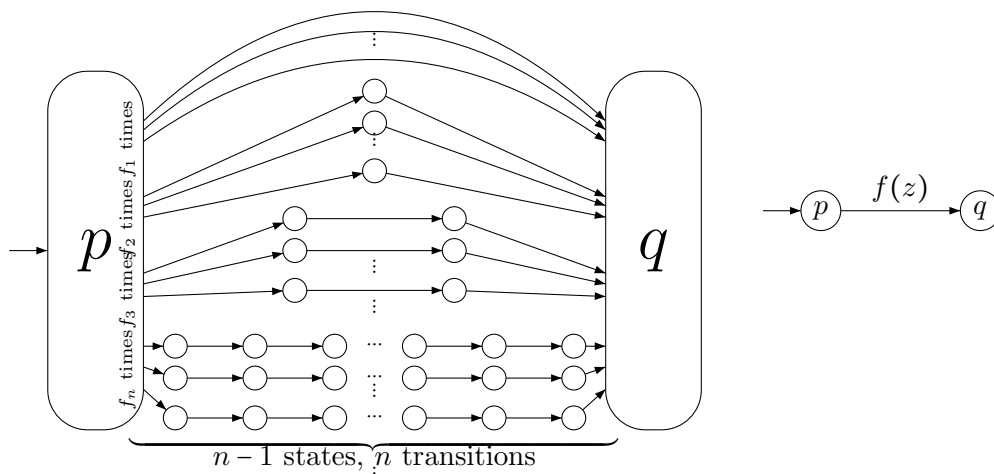

FIGURE 7. Transitions from the state p to q and transition in parallel.

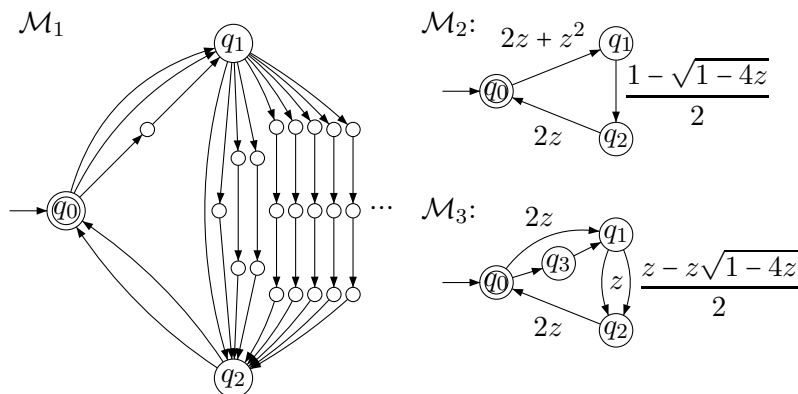

FIGURE 8. Counting automata with transitions in parallel, Example 11.

This example shows that a counting automaton can have different equivalent representations.

Definition 12. Two counting automata \mathcal{M}_1 and \mathcal{M}_2 are equivalent if for all integer $n \geq 0$, $L^{(n)}(\mathcal{M}_1) = L^{(n)}(\mathcal{M}_2)$. This is denoted by $\mathcal{M}_1 \cong \mathcal{M}_2$.

Definition 13. Let $f(z) = \sum_{t=0}^{\infty} f_t z^t$ be a power series (or a polynomial). We define ${}_n f(z)$ as the polynomial ${}_n f(z) = \sum_{t=0}^n f_t z^t$.

Theorem 14 (Second Convergence Theorem). Let \mathcal{M} be an automaton, and let $f_1^q(z), f_2^q(z), \dots$, be the transitions in parallel from state $q \in Q$ in a counting automaton of \mathcal{M} . Then \mathcal{M} is convergent if the series

$$F^q(z) = \sum_{k=1}^{\infty} f_k^q(z)$$

is a convergent series for each visible state $q \in Q$ of the counting automaton.

Proof. Any word of length n is accepted by \mathcal{M} if there is a path from q_0 to some final state. Since the hidden states in a transition in parallel are not final states, then the paths from a visible state to another visible state, corresponding to the terms $f_{n+1}z^{n+1}, f_{n+2}z^{n+2}, \dots$ of a

transition in parallel $f(z)$ in a counting automaton of \mathcal{M} , are not accepting paths. Let \mathcal{M}' be an automaton obtained by replacing all transitions in parallel $f(z)$ in a counting automaton of \mathcal{M} by the transition ${}_n f(z)$, then clearly $L^{(n)}(\mathcal{M}) = L^{(n)}(\mathcal{M}')$ for all $n \geq 0$. On the other hand, the number of transitions of each visible state $q \in Q'$ in \mathcal{M}' is finite because

$$\sum_{k=1}^{\infty} {}_n f_k^q(1) = {}_n F^q(1) < \infty,$$

and from each of the hidden state starts a single transition. Hence, by Theorem 9, \mathcal{M}' is convergent. Hence $L^{(n)}(\mathcal{M}) = L^{(n)}(\mathcal{M}')$ is finite for all $n \geq 0$, therefore \mathcal{M} is convergent. \square

Proposition 15. *If $f(z)$ is a polynomial transition in parallel from state p to q in a finite counting automaton \mathcal{M} , then this gives rise to an equation in the system of GF's equations of \mathcal{M} :*

$$L_p = f(z)L_q + [p \in F] + \dots$$

Proof. Let $f(z) = f_1 z + f_2 z^2 + \dots + f_n z^n$ be a polynomial transition in parallel, then the set of transitions in parallel corresponding to the term $f_k z^k$, $1 \leq k \leq n$, can be represented with a graph as in Figure 9.

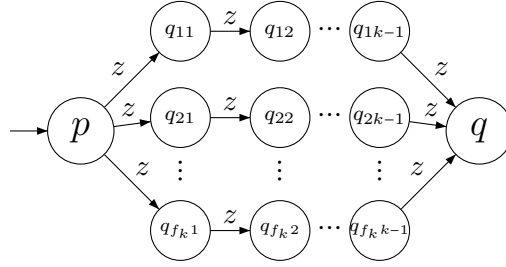

FIGURE 9. Transition in parallel corresponding to the term $f_k z^k$.

Therefore the GF equation is

$$L_p(z) = zL_{q_{11}}(z) + zL_{q_{21}}(z) + \dots + zL_{q_{f_k1}}(z) + [p \in F].$$

Since $L_{q_{i1}}(z) = z^{i-1}L_q(z)$, then

$$\begin{aligned} L_p(z) &= \overbrace{z^k L_q(z) + z^k L_q(z) + \dots + z^k L_q(z)}^{f_k \text{-times}} + [p \in F] \\ &= f_k z^k L_q(z) + [p \in F]. \end{aligned}$$

Considering each of the terms f_k , ($1 \leq k \leq n$), then

$$\begin{aligned} L_p(z) &= f_1 z L_q(z) + f_2 z^2 L_q(z) + \dots + f_n z^n L_q(z) + [p \in F] \\ &= f(z)L_q(z) + [p \in F]. \end{aligned}$$

\square

Proposition 16. *Let \mathcal{M} be a convergent automaton such that a counting automaton of \mathcal{M} has a finite number of visible states q_0, q_1, \dots, q_r , in which the number of transitions in parallel starting from each state is finite. Let*

$f_1^{q_t}(z), f_2^{q_t}(z), \dots, f_{s(t)}^{q_t}(z)$ be the transitions in parallel from the state $q_t \in Q$. Then the GF for the language $L(\mathcal{M})$ is $L_{q_0}(z)$. It is obtained by solving the system of $r+1$ GFs equations

$$L(q_t)(z) = f_1^{q_t}(z)L(q_{t_1})(z) + f_2^{q_t}(z)L(q_{t_2})(z) + \dots + f_{s(t)}^{q_t}(z)L(q_{t_{s(t)}})(z) + [q_t \in F],$$

with $0 \leq t \leq r$, where q_{t_k} is the visible state joined with q_t through the transition in parallel $f_k^{q_t}$, and $L(q_{t_k})$ is the GF for the language accepted by \mathcal{M} if q_{t_k} is the initial state.

Proof. Let $n \geq 0$ be an integer, and let \mathcal{M}' be the automaton obtained by replacing the $s(t)$ transitions in parallel $(f_1^{q_t}(z), f_2^{q_t}(z), \dots, f_{s(t)}^{q_t}(z))$ leaving the state $q_t \in Q$ by the transitions ${}_n f_1^{q_t}(z), {}_n f_2^{q_t}(z), \dots, {}_n f_{s(t)}^{q_t}(z)$, with $0 \leq t \leq r$. Hence \mathcal{M}' is a finite automaton and from Proposition 15 the GF of \mathcal{M}' is obtained by solving the following system for $L'(q_0)$

$$L'(q_t)(z) = {}_n f_1^{q_t}(z)L'(q_{t_1})(z) + {}_n f_2^{q_t}(z)L'(q_{t_2})(z) + \dots + {}_n f_{s(t)}^{q_t}(z)L'(q_{t_{s(t)}})(z) + [q_t \in F],$$

where $0 \leq t \leq r$. Therefore $L'(q_0)(z)$ is a rational function R evaluated at variables ${}_n f_k^{q_t}(z)$, with $0 \leq t \leq r, 1 \leq k \leq s(t)$. We denoted this by $L'(q_0)(z) = R({}_n f_k^{q_t}(z))$. It is clear that ${}_n L'(q_0)(z) = {}_n L(q_0)(z)$. Finally we consider the series $R(f_k^{q_t}(z))$, as the calculation of a rational expression involves only a finite number of sums, differences, products and reciprocals, and after applying one of these operations the n -th term of the power series depends only on the first n terms of the series involved in the operation. Hence, $R({}_n f_k^{q_t}(z)) = {}_n R(f_k^{q_t}(z))$ for all $n \geq 0$. Therefore the GF of \mathcal{M} is $R(f_k^{q_t}(z)) = L(q_0)$. \square

Example 17. The system of GFs equations associated with \mathcal{M}_2 , see Example 11, is

$$\begin{cases} L_0 &= (2z + z^2)L_1 + 1 \\ L_1 &= \frac{1 - \sqrt{1 - 4z}}{2}L_2 \\ L_2 &= 2zL_0. \end{cases}$$

Solving the system for L_0 , we find the GF for the language \mathcal{M}_2 and therefore of \mathcal{M}_1 and \mathcal{M}_3 .

$$L_0 = \frac{1}{1 - (2z^2 + z^3)(1 - \sqrt{1 - 4z})} = 1 + 4z^3 + 6z^4 + 10z^5 + 40z^6 + 114z^7 + \dots$$

4. COUNTING AUTOMATA METHODOLOGY (CAM)

A counting automaton associated with an automaton \mathcal{M} can be used to model combinatorial objects if there is a bijection between all words recognized by the automaton \mathcal{M} and the combinatorial objects. Such method, along with the previous theorems and propositions constitute the **Counting Automata Methodology (CAM)**.

We distinguish three phases in the CAM:

- (1) Given a problem of enumerative combinatorics, we have to find a convergent automaton (see Theorems 9 and 14) whose GF is the solution of the problem.
- (2) Find a general formula for the GF of \mathcal{M}' ($f_i = L_{0i}$), see Propositions 15 and 16. The GF of the automaton \mathcal{M}' is obtained from \mathcal{M} by removing a set of states or edges. Sometimes we find a relation of iterative type, such as a continued fraction. Moreover, it is practical to use equivalent automata, see Definition 12.
- (3) Find the GF $f(z)$ to which the GFs associated with each \mathcal{M}' converge, which is guaranteed by the convergence theorems.

4.1. Examples of the Counting Automata Methodology.

Example 18. A Motzkin path of length n is a lattice path of $\mathbb{Z} \times \mathbb{Z}$ running from $(0,0)$ to $(n,0)$ that never passes below the x -axis and whose permitted steps are the up diagonal step $U = (1,1)$, the down diagonal step $D = (1,-1)$ and the horizontal step $H = (1,0)$, called rise, fall and level step, respectively. The number of Motzkin paths of length n is the n -th Motzkin number m_n , sequence A001006. Many other examples of bijections between Motzkin numbers and others combinatorial objects can be found in [2].

The number of words of length n recognized by the convergent automaton \mathcal{M}_{Mot} , see Figure 10, is the n -th Motzkin number and its GF is

$$\begin{aligned}
 (1) \quad M(z) &= \sum_{i=0}^{\infty} m_i z^i = \frac{1 - z - \sqrt{1 - 2z - 3z^2}}{2z^2} \\
 (2) \quad &= \frac{1}{1 - z - \frac{z^2}{1 - z - \frac{z^2}{1 - z - \frac{z^2}{\ddots}}}}.
 \end{aligned}$$

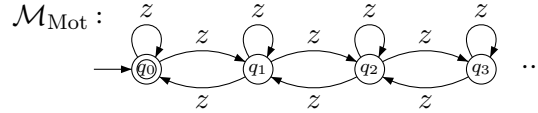

FIGURE 10. Convergent Automaton associated with Motzkin Paths.

In this case the edge from state q_i to state q_{i+1} represents a rise, the edge from the state q_{i+1} to q_i represents a fall and the loops represent the level steps, see Table 1.

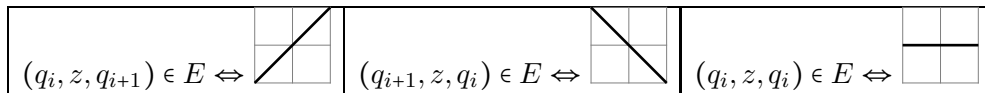

TABLE 1. Bijection between \mathcal{M}_{Mot} and Motzkin paths.

Moreover, it is clear that a word is recognized by \mathcal{M}_{Mot} if and only if the number of steps to the right and to the left coincide, which ensures that the path is well formed. Then $m_n = |\{w \in L(\mathcal{M}_{\text{Mot}}) : |w| = n\}| = L^{(n)}(\mathcal{M}_{\text{Mot}})$.

Let $\mathcal{M}_{\text{Mot}s}$, $s \geq 1$ be the automaton obtained from \mathcal{M}_{Mot} , by deleting the states q_{s+1}, q_{s+2}, \dots . Therefore the system of GFs equations of $\mathcal{M}_{\text{Mot}s}$ is

$$\begin{cases} L_0 = zL_0 + zL_1 + 1, \\ L_i = zL_{i-1} + zL_i + zL_{i+1}, & 1 \leq i \leq s-1, \\ L_s = zL_{s-1} + zL_s. \end{cases}$$

Substituting repeatedly into each equation L_i , we have

$$L_0 = \left. \begin{array}{c} H \\ \hline 1 - \frac{F^2}{1 - \frac{F^2}{1 - \frac{F^2}{\vdots}}}} \end{array} \right\} s \text{ times}$$

where $F = \frac{z}{1-z}$ and $H = \frac{1}{1-z}$. Since \mathcal{M}_{Mot} is convergent, then as $s \rightarrow \infty$ we obtain a convergent continued fraction M of the GF of \mathcal{M}_{Mot} . Moreover,

$$M = \frac{H}{1 - F^2 \left(\frac{M}{H} \right)}.$$

Hence $z^2 M^2 - (1-z)M + 1 = 0$ and

$$M(z) = \frac{1 - z \pm \sqrt{1 - 2z - 3z^2}}{2z^2}.$$

Since $\epsilon \in L(\mathcal{M}_{\text{Mot}})$, $M \rightarrow 0$ as $z \rightarrow 0$. Hence we take the negative sign for the radical in $M(z)$.

Example 19. The number of Motzkin paths of length n without level steps on the x -axis (Riordan paths) is the n -th Riordan number r_n , sequence A005043. The number of words of length n recognized by the convergent automaton \mathcal{M}_R , see Figure 11(left), is the n -th Riordan number and its GF is

$$(3) \quad R(z) = \sum_{i=0}^{\infty} r_i z^i = \frac{1 + z - \sqrt{1 - 2z - 3z^2}}{2z(1+z)}$$

$$(4) \quad = \frac{1}{1 - \frac{z^2}{1 - z - \frac{z^2}{\ddots}}}$$

In the automaton \mathcal{M}_R , the initial loop was removed to avoid the level steps on the x -axis, then it is clear that $r_n = |\{w \in L(\mathcal{M}_R) : |w| = n\}| = L^{(n)}(\mathcal{M}_R)$. Moreover, we can use equivalent automata because the automaton \mathcal{M}_{Mot} is a subautomaton of \mathcal{M}_R . Hence, there is an automaton \mathcal{M}'_R with only two visible states, such that $\mathcal{M}'_R \cong \mathcal{M}_R$, see Figure 11(right).

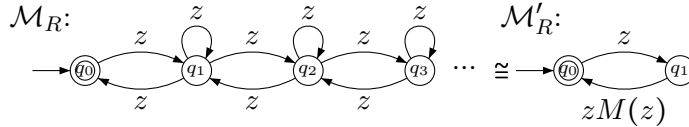

FIGURE 11. Equivalent Automata $\mathcal{M}'_R \cong \mathcal{M}_R$, Example 19.

Then we have the following system of GFs equations

$$\begin{cases} R(z) = 1 + zL_1 \\ L_1 = zM(z)R(z), \end{cases}$$

where $M(z)$ is the GF for Motzkin numbers. Whence

$$(5) \quad R(z) = 1 + z^2 M(z) R(z),$$

then

$$R(z) = \frac{1}{1 - z^2 M(z)} = \frac{2}{1 + z + \sqrt{1 - 2z - 3z^2}} = \frac{1 + z - \sqrt{1 - 2z - 3z^2}}{2z(1 + z)}$$

Moreover, from Equation (5)

$$r_n = \sum_{j=0}^{n-2} m_j r_{n-j-2}, \quad n \geq 2.$$

We also have $R(z) = \frac{1+zM(z)}{1+z}$ then $(1+z)R(z) = 1+zM(z)$. Hence $r_{n+1} + r_n = m_n$, $n \geq 0$, this equation is derived in [2] using a combinatorial argument.

5. LINEAR INFINITE COUNTING AUTOMATON

In this section we study a family of counting automata and their GFs.

Definition 20. A linear graph G is a 4-tuple $G = (V, A, n, F)$ where

- $V \subseteq \mathbb{Z}$ is a nonempty set of the labelled vertices of G . If $m \in V$, the vertex is labelled by m .
- $A = (A_-, A_{\curvearrowright}, A_{\curvearrowleft})$ is the set of edges of G , where
 - $A_- = \{i \in V : \text{there exists a loop at vertex } i\}$.
 - $A_{\curvearrowright} = \{i \in V : \text{there exists an edge from vertex } i \text{ to vertex } i + 1\}$.
 - $A_{\curvearrowleft} = \{i \in V : \text{there exists an edge from vertex } i + 1 \text{ to vertex } i\}$.
- $n \in V$ is the initial vertex.
- $F \subseteq V$ is the set of final vertices.

In particular, if $V = \mathbb{N}$, $A = (\mathbb{N}, \mathbb{N}, \mathbb{N})$, $n = 0$, $F = \{0\}$, we say that G is a *complete linear graph* and is denoted by G_L . If $V = \mathbb{Z}$, $A = (\mathbb{Z}, \mathbb{Z}, \mathbb{Z})$, $n = 0$, $F = \{0\}$, we say that G is a *complete bilinear graph* and is denoted by G_{BT} .

Example 21. Consider the linear graph $V = \mathbb{N}$, $A = (2\mathbb{N}, \mathbb{N}, \mathbb{N})$, $n = 0$, $F = \{0\}$. It is displayed in Figure 12.

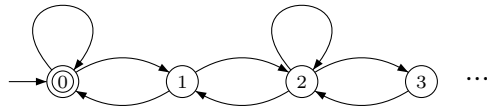

FIGURE 12. Linear graph, Example 21.

Definition 22. A linear counting automaton associated with the linear graph G is a weighted automaton \mathcal{M}_c determined by the pair $\mathcal{M}_c = (G, E)$, where E is the set of weighted transitions defined by the triple $E = (E_-, E_{\curvearrowright}, E_{\curvearrowleft})$ where

- $E_- = \{h_i(z) : i \in A_-\}$.
- $E_{\curvearrowright} = \{f_i(z) : i \in A_{\curvearrowright}\}$.
- $E_{\curvearrowleft} = \{g_i(z) : i \in A_{\curvearrowleft}\}$.

and for all integer i , $f_i(z)$, $g_i(z)$ and $h_i(z)$ are transitions in parallel.

The set of all counting automata is denoted by \mathcal{M}_c^* .

Example 23. Consider the linear counting automaton $\mathcal{M}_c = (G, E = (\emptyset, \{z\}, \{z\}))$, where $G = (\mathbb{N}, (\emptyset, \mathbb{N}, \mathbb{N}), 0, \{0\})$. It is displayed in Figure 13.

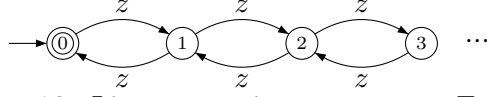
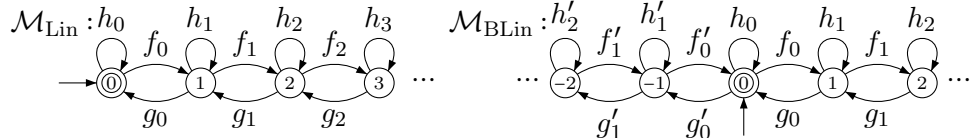

FIGURE 13. Linear counting automaton, Example 23.

The linear infinite counting automaton associated with the complete linear graph G_L is denoted by \mathcal{M}_{Lin} , see Figure 14(left). Similarly, the linear infinite counting automaton associated with the complete bilinear graph G_{BL} is denoted by \mathcal{M}_{BLin} , see Figure 14(right).

 FIGURE 14. Infinite counting automata \mathcal{M}_{Lin} and \mathcal{M}_{BLin} .

5.1. Generating Function of \mathcal{M}_{Lin} and \mathcal{M}_{BLin} .

Theorem 24. *The generating function of \mathcal{M}_{Lin} , see Figure 14 (left), is*

$$E(z) = \frac{1}{1 - h_0(z) - \frac{f_0(z)g_0(z)}{1 - h_1(z) - \frac{f_1(z)g_1(z)}{\ddots}}},$$

where $f_i(z), g_i(z)$ and $h_i(z)$ are transitions in parallel for all integer $i \geq 0$.

Proof. We denoted by \mathcal{M}_{Lin-s} the automaton obtained from \mathcal{M}_{Lin} deleting the vertices $s, s+1, s+2, \dots$. The system of GFs equations of $\mathcal{M}_{Lin-s}, s \geq 1$, is

$$\begin{cases} L_0 = h_0 L_0 + f_0 L_1 + 1 \\ L_i = g_{i-1} L_{i-1} + h_i L_i + f_i L_{i+1}, & 1 \leq i \leq s-1 \\ L_s = g_{s-1} L_{s-1} + h_s L_s. \end{cases}$$

Substituting repeatedly into each equation L_i , we have

$$L_0 = \frac{1}{1 - h_0 - \frac{f_0 g_0}{1 - h_1 - \frac{f_1 g_1}{\ddots}} \frac{f_{s-1} g_{s-1}}{1 - h_{s-1} - \frac{f_s g_s}{1 - h_s}}}$$

Since \mathcal{M}_{Lin} is convergent, then when $s \rightarrow \infty$ we obtain the convergent continued fraction $E(z)$ of the GF of \mathcal{M}_{Lin} . \square

The last theorem coincides with Theorem 1 in [12] and Theorem 9.1 in [20]. However, this presentation extends their applications, taking into account that $f_i(z), g_i(z)$ and $h_i(z)$ are GFs, which can be GFs of several variables.

Corollary 25. *If for all integer $i \geq 0$, $f_i(z) = f(z)$, $g_i(z) = g(z)$ and $h_i(z) = h(z)$ in \mathcal{M}_{Lin} , then the GF is*

$$\begin{aligned}
 (6) \quad B(z) &= \frac{1 - h(z) - \sqrt{(1 - h(z))^2 - 4f(z)g(z)}}{2f(z)g(z)} \\
 (7) \quad &= \sum_{n=0}^{\infty} \sum_{m=0}^{\infty} C_n \binom{m+2n}{m} (f(z)g(z))^n (h(z))^m \\
 (8) \quad &= \frac{1}{1 - h(z) - \frac{f(z)g(z)}{1 - h(z) - \frac{f(z)g(z)}{1 - h(z) - \frac{f(z)g(z)}{\ddots}}}},
 \end{aligned}$$

where $f(z), g(z)$ and $h(z)$ are transitions in parallel and C_n is the n -th Catalan number, sequence A000108.

Proof. From Theorem 24 the GF is

$$B(z) = \frac{1}{1 - h(z) - \frac{f(z)g(z)}{1 - h(z) - \frac{f(z)g(z)}{1 - h(z) - \frac{f(z)g(z)}{\ddots}}}}.$$

Since the counting automaton is convergent, then

$$B(z) = \frac{1}{1 - h(z) - f(z)g(z)B(z)}.$$

Hence

$$B(z) = \frac{1 - h(z) - \sqrt{(1 - h(z))^2 - 4f(z)g(z)}}{2f(z)g(z)}.$$

Equation (7) is obtained from observing that

$$\begin{aligned}
 B(z) &= \frac{1 - h(z) - \sqrt{(1 - h(z))^2 - 4f(z)g(z)}}{2f(z)g(z)} \\
 &= \frac{1}{1 - h(z)} \frac{1 - \sqrt{1 - 4\frac{f(z)g(z)}{(1 - h(z))^2}}}{2\frac{f(z)g(z)}{(1 - h(z))^2}} \\
 &= \frac{1}{1 - h(z)} C(u),
 \end{aligned}$$

where $u = \frac{f(z)g(z)}{(1-h(z))^2}$ and $C(z) = \frac{1-\sqrt{1-4z}}{2z}$ is the GF for Catalan numbers. Therefore

$$\begin{aligned} B(z) &= \frac{1}{1-h(z)} C(u) = \frac{1}{1-h(z)} \sum_{n=0}^{\infty} C_n u^n \\ &= \sum_{n=0}^{\infty} C_n \frac{(f(z)g(z))^n}{(1-h(z))^{2n+1}} \\ &= \sum_{n=0}^{\infty} \sum_{m=0}^{\infty} C_n \binom{m+2n}{m} (f(z)g(z))^n (h(z))^m. \end{aligned}$$

□

Example 26. If $h(z) = f(z) = g(z) = z$ in Corollary 25, we obtain the GF for Motzkin paths $M(z)$, see Example 18. Moreover,

$$m_s = \sum_{n=0}^{\lfloor \frac{s}{2} \rfloor} C_n \binom{s}{2n}.$$

Indeed, using the Equation (7) it follows that

$$M(z) = \sum_{n=0}^{\infty} \sum_{m=0}^{\infty} C_n \binom{m+2n}{m} z^{2n+m},$$

taking $t = 2n + m$

$$M(z) = \sum_{n=0}^{\infty} \sum_{t=2n}^{\infty} C_n \binom{t}{t-2n} z^t,$$

hence

$$m_s = \sum_{n=0}^{\lfloor \frac{s}{2} \rfloor} C_n \binom{s}{s-2n} = \sum_{n=0}^{\lfloor \frac{s}{2} \rfloor} C_n \binom{s}{2n}.$$

5.2. Applications of CAM to k -colored Motzkin paths and generalized Motzkin paths.

Example 27. A k -colored Motzkin path of length n is a Motzkin path such that the level steps are labelled by k colors. The number of k -colored Motzkin paths of length n is the n -th k -colored Motzkin number, $m_{n,k}$.

If $f(z) = z = g(z)$ and $h(z) = kz$ in Corollary 25, we obtain the GF for k -colored Motzkin paths

$$M_k(z) = \sum_{i=0}^{\infty} m_{i,k} z^i = \frac{1 - kz - \sqrt{(1 - kz)^2 - 4z^2}}{2z^2},$$

and

$$(9) \quad m_{n,k} = \sum_{n=0}^{\lfloor \frac{s}{2} \rfloor} C_n \binom{s}{2n} k^{s-2n}.$$

Equation (9) coincides with Equation (8) of [22]. In particular, if $k = 2$

$$\begin{aligned} M_2(z) &= \sum_{i=0}^{\infty} m_{i,2} z^i = \frac{1 - 2z - \sqrt{1 - 4z}}{2z} \\ &= z + 2z^2 + 5z^3 + 14z^4 + 42z^5 + 132z^6 + 429z^7 + 1430z^8 + \dots \end{aligned}$$

then $zM_2(z) = C(z) - 1$ so the n -th 2-colored Motzkin number is equal to C_{n+1} . In [10] and [28] there are some bijections between the numbers $m_{n,2}$ and other combinatorial objects. If $k = 3$

$$M_3(z) = \sum_{i=0}^{\infty} m_{i,3} z^i = \frac{1 - 3z - \sqrt{1 - 6z + 5z^2}}{2z}$$

$$= z + 3z^2 + 10z^3 + 36z^4 + 137z^5 + 543z^6 + 2219z^7 + 9285z^8 + \dots,$$

then the sequence A002212 is obtained, some properties about these numbers are established in [9, 24]. If $k = 4$ the sequence A005572 which starts 1, 4, 17, 76, 354, 1704, 8421, 42508 is obtained.

Example 28. A generalized Motzkin path of length n is a Motzkin path such that the level step is $H = (k, 1)$ where k is a fixed positive integer. The number of generalized Motzkin paths of length n is the n -th generalized Motzkin number m_n^k . If $f(z) = z = g(z)$ and $h(z) = z^k$ in Corollary 25, we obtain the GF for generalized Motzkin path.

$$M^{(k)}(z) = \sum_{i=0}^{\infty} m_i^k z^i = \frac{1 - z^k - \sqrt{(1 - z^k)^2 - 4z^2}}{2z^2}.$$

The last equation coincides with the Equation (1) of [1]. If $k = 2$, we obtain the GF for Schröder paths, sequence A006318.

$$M^{(2)}(z) = \sum_{i=0}^{\infty} m_i^2 z^i = \frac{1 - z^2 - \sqrt{1 - 6z^2 + z^4}}{2z^2}$$

$$= 1 + 2z^2 + 6z^4 + 22z^6 + 90z^8 + 394z^{10} + 1806z^{12} + \dots$$

There is a relation well known between the numbers m_i^2 and Narayana numbers $N(n, k) = \frac{1}{n} \binom{n}{k} \binom{n}{k-1}$ with $1 \leq k \leq n$ which enumerate a large variety of combinatorial objects, see sequence A001263. In particular, there is the following identity, [7]

$$m_n^2 = \sum_{k=0}^n N(n, k) 2^k.$$

Example 29. If $f(z) = z = g(z)$ and $h(z) = \frac{kz}{1-z}$ in Corollary 25, we obtain the GF $F_k(z)$ for the lattice path which never goes below the x -axis, from $(0, 0)$ to $(n, 0)$ consisting of up steps $U = (1, 1)$, down steps $D = (1, -1)$ and horizontal steps $H(k) = (k, 0)$ for every positive integer k and can be labelled by k colors

$$F_k(z) = \frac{1 - (1+k)z - \sqrt{1 - (2+2k)z + (-3+2k+k^2)z^2 + 8z^3 - 4z^4}}{2z^2(1-z)},$$

and

$$f_s^{(k)} = \sum_{n=0}^s \sum_{m=0}^{s-2n} C_n \binom{m+2n}{m} \binom{s-2n-1}{s-m-2n} k^m,$$

where $f_s^{(k)} = [z^s] F_k(z)$. From Corollary 25 we have the first equation, besides

$$\begin{aligned} F_k(z) &= \sum_{n=0}^{\infty} \sum_{m=0}^{\infty} C_n \binom{m+2n}{m} z^{2n} \left(\frac{kz}{1-z} \right)^m \\ &= \sum_{n=0}^{\infty} \sum_{m=0}^{\infty} \sum_{i=0}^{\infty} C_n \binom{m+2n}{m} \binom{i+m-1}{i} k^m z^{2n+m+i}, \end{aligned}$$

taking $t = 2n + m + i$

$$\sum_{n=0}^{\infty} \sum_{m=0}^{\infty} \sum_{t=2n+m}^{\infty} C_n \binom{m+2n}{m} \binom{t-2n-1}{t-m-2n} k^m z^t,$$

hence

$$f_s^{(k)} = \sum_{n=0}^s \sum_{m=0}^{s-2n} C_n \binom{m+2n}{m} \binom{s-2n-1}{s-m-2n} k^m.$$

If $k = 1$ the sequence A135052 is obtained.

The last example shows the variety of results that can be obtained with the CAM, simply by changing the different transitions in parallel, i.e., changing the GFs $f_i(z)$, $g_i(z)$ and $h_i(z)$.

Definition 30. For all integer $i \geq 0$ we define the continued fraction $E_i(z)$ by:

$$E_i(z) = \frac{1}{1 - h_i(z) - \frac{f_i(z)g_i(z)}{1 - h_{i+1}(z) - \frac{f_{i+1}(z)g_{i+1}(z)}{1 - h_{i+2}(z) - \frac{f_{i+2}(z)g_{i+2}(z)}{\ddots}}}}},$$

where $f_i(z)$, $g_i(z)$, $h_i(z)$ are transitions in parallel for all integers positive i .

Theorem 31. The generating function of $\mathcal{M}_{\text{BLin}}$, see Figure 14(right), is

$$E_b(z) = \frac{1}{1 - h_0(z) - f_0(z)g_0(z)E_1(z) - f'_0(z)g'_0(z)E'_1(z)},$$

where $f_i(z)$, $f'_i(z)$, $g_i(z)$, $g'_i(z)$, $h_i(z)$ and $h'_i(z)$ are transitions in parallel for all $i \in \mathbb{Z}$.

Proof. It is clear that the automaton $\mathcal{M}_{\text{BLin}}$ is equivalent to the automaton in Figure 15.

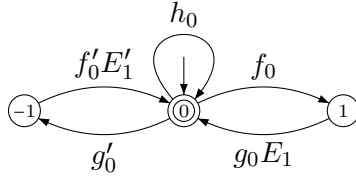

FIGURE 15. Equivalent automaton to $\mathcal{M}_{\text{BLin}}$.

Therefore, we have the following system of GFs equations

$$\begin{cases} L_0 = h_0 L_0 + f_0 L_1 + g'_0 L'_1 + 1 \\ L_1 = g_0 E_1 L_0 \\ L'_1 = f_0 E'_1 L_0, \end{cases}$$

where $L'_1 = L_{-1}$. Solving the system for L_0 we obtain the GF of $\mathcal{M}_{\text{BLin}}$. \square

Corollary 32. *If for all integer i , $f_i(z) = f(z) = f'_i(z)$, $g_i(z) = g(z) = g'_i(z)$ and $h_i(z) = h(z) = h'_i(z)$ in $\mathcal{M}_{\text{BLin}}$, then we have the GF*

$$(10) \quad B_b(z) = \frac{1}{\sqrt{(1-h(z))^2 - 4f(z)g(z)}}$$

$$(11) \quad = \frac{1}{1-h(z) - \frac{2f(z)g(z)}{1-h(z) - \frac{f(z)g(z)}{1-h(z) - \frac{f(z)g(z)}{\ddots}}}}$$

where $f(z), g(z)$ and $h(z)$ are transitions in parallel.

Proof. It is clear from Equation (10)

$$B_b(z) = \frac{1}{1-h(z) - 2f(z)g(z)B(z)},$$

where $B(z)$ is the GF in Corollary 25. The continued fraction is obtained from the same corollary. \square

Corollary 33. *If $f(z) = g(z)$ in Corollary 32, then we have the GF*

$$(12) \quad B_b(z) = \frac{1}{1-h(z)} + \sum_{n=1}^{\infty} \sum_{k=0}^{\infty} \sum_{l=0}^{\infty} 2^n \frac{n}{n+2k} \binom{n+2k}{k} \binom{l+2n+2k}{l} f(z)^{2n+2k} h(z)^l,$$

where $f(z), g(z)$ and $h(z)$ are transitions in parallel.

Proof. From Theorem 31 we have

$$B_b(z) = \frac{1}{1-h(z) - 2f^2(z)B(z)},$$

where $B(z)$ is the GF in Corollary 25 with $g(z) = f(z)$, i.e.,

$$B(z) = \frac{1-h(z) - \sqrt{(1-h(z))^2 - 4f^2(z)}}{2f^2(z)} = \frac{1}{1-h(z)} C(u),$$

where $u = \frac{f^2(z)}{(1-h(z))^2}$ and $C(u)$ is the GF for Catalan numbers. The powers of the GF for Catalan numbers (see Eq. 5.70 of [15]), satisfy that

$$C^n(u) = \sum_{k=0}^{\infty} \frac{n}{n+2k} \binom{n+2k}{k} u^k, \quad n \geq 1.$$

Then

$$\begin{aligned}
B_b(z) &= \frac{1}{1-h(z)-2f^2(z)\frac{C(u)}{1-h(z)}} = \frac{1}{1-h(z)} \frac{1}{1-2uC(u)} \\
&= \frac{1}{1-h(z)} \sum_{n=0}^{\infty} (2uC(u))^n = \frac{1}{1-h(z)} + \sum_{n=1}^{\infty} (2uC(u))^n \\
&= \frac{1}{1-h(z)} + \sum_{n=1}^{\infty} \sum_{k=0}^{\infty} 2^n \frac{n}{n+2k} \binom{n+2k}{k} \frac{f^{2n}(z)}{(1-h(z))^{2n}} u^k \\
&= \frac{1}{1-h(z)} + \sum_{n=1}^{\infty} \sum_{k=0}^{\infty} 2^n \frac{n}{n+2k} \binom{n+2k}{k} \frac{f^{2n+2k}(z)}{(1-h(z))^{2n+2k}} \\
&= \frac{1}{1-h(z)} + \sum_{n=1}^{\infty} \sum_{k=0}^{\infty} \sum_{l=0}^{\infty} 2^n \frac{n}{n+2k} \binom{n+2k}{k} \binom{l+2n+2k}{l} f^{2n+2k}(z) h^l(z).
\end{aligned}$$

□

Example 34. A Grand Motzkin path of length n is a Motzkin path without the condition that never passes below the x -axis. The number of Grand Motzkin paths of length n is the n -th Grand Motzkin number m_n^b , sequence A002426.

The number of words of length n recognized by the convergent automaton $\mathcal{M}_{\text{BLin}}$, see Figure 14(right), with $f_i(z) = z = g_i(z) = h_i(z) = f'_i(z) = g'_i(z) = h'_i(z)$ for all integer i , is the n -th Grand Motzkin number and its GF is

$$(13) \quad M^b(z) = \sum_{i=0}^{\infty} m_i^b z^i \frac{1}{\sqrt{1-2z-3z^2}}$$

$$(14) \quad = \frac{1}{1-z - \frac{2z^2}{1-z - \frac{z^2}{1-z - \frac{z^2}{\ddots}}}}$$

$$(15) \quad = \frac{1}{1-z} + \sum_{n=1}^{\infty} \sum_{k=0}^{\infty} \sum_{l=0}^{\infty} 2^n \frac{n}{n+2k} \binom{n+2k}{k} \binom{l+2n+2k}{l} z^{2n+2k+l}.$$

These equations are easily obtained from Corollary 32 and 33.

In this case the edge from the state i and $i+1$ and vice versa, represent a rise or a fall above the x -axis and the edge from the state $-i$ and $-(i+1)$ and vice versa, represent a rise or a fall below the x -axis, and the loops represent the level steps. Moreover, it is clear that a word is recognized by $\mathcal{M}_{\text{BLin}}$ if and only if it has an equal number of steps to the right and to the left, then

$$m_n^b = |\{w \in L(\mathcal{M}_{\text{BLin}}) : |w| = n\}| = L^{(n)}(\mathcal{M}_{\text{BLin}}).$$

On the other hand, taking $t = 2n + 2k + l$ in Equation (15), we have

$$\sum_{i=0}^{\infty} m_i^b z^i = \frac{1}{1-z} + \sum_{n=1}^{\infty} \sum_{k=0}^{\infty} \sum_{t=2n+2k}^{\infty} 2^n \frac{n}{n+2k} \binom{n+2k}{k} \binom{t}{t-2n-2k} z^t,$$

then

$$m_s^b = 1 + \sum_{n=0}^s \sum_{k=0}^{\lfloor \frac{s-2n}{2} \rfloor} 2^n \frac{n}{n+2k} \binom{n+2k}{k} \binom{s}{2n+2k}.$$

The Grand Motzkin paths are related to the central trinomial coefficients. Let T_n denote the n -th central trinomial coefficient, defined as the coefficient of x^n in the expression of $(1+x+x^2)^n$ or it can also be defined as the coefficient of the form $x^n y^n z^k$ in the expression of $(x+y+z)^n$. For example if $n=2$ then $(x+y+z)^2 = x^2 + y^2 + z^2 + 2xy + 2xz + 2yz$, hence $T_2 = 3$. It is clear that the Grand Dyck paths are enumerated by the central binomial coefficients, i.e., $T_n = m_n^b$. For integers a, b, c we call the coefficient of x^n in the expression $(a+bx+cx^2)^n$ the generalized central trinomial coefficient, T_n^* or it can also be defined as the coefficients of the form $x^n y^n z^k$ in the expression $(a+bx+cx^2)^n$. Taking $f(z) = az = f'(z)$, $g(z) = cz = g'(z)$ and $h(z) = bz = h'(z)$ in the counting automaton $\mathcal{M}_{\text{BLin}}$, we obtain the GF for the numbers T_n^* .

$$\begin{aligned} \sum_{i=0}^{\infty} T_i^* z^i &= \frac{1}{\sqrt{(1-bz)^2 - 4acz^2}} = \frac{1}{\sqrt{1-2bz + (b^2-4ac)z^2}} \\ &= \frac{1}{1-bz - \frac{2acz^2}{1-bz - \frac{acz^2}{1-bz - \frac{acz^2}{\ddots}}}} \end{aligned}$$

The last GF coincides with Equation (3) of [19]. By using the Binomial Theorem twice and the identity $\binom{n}{k} \binom{n-k}{n-2k} = \binom{2k}{k} \binom{n}{2k}$, we have

$$T_n^* = \sum_{k=0}^{\lfloor n/2 \rfloor} \binom{2k}{k} \binom{n}{2k} b^{n-2k} (ac)^k.$$

Since $m_n^b = T_n$, then

$$\sum_{k=0}^{\lfloor s/2 \rfloor} \binom{2k}{k} \binom{s}{2k} = 1 + \sum_{n=0}^s \sum_{k=0}^{\lfloor \frac{s-2n}{2} \rfloor} 2^n \frac{n}{n+2k} \binom{n+2k}{k} \binom{s}{2n+2k}.$$

REFERENCES

- [1] E. Barucci, E. Pergola, R. Pinzani, and S. Rinaldi. ECO method and hill-free generalized Motzkin paths. *Séminaire Lotharingien de Combinatoire*, 46:1–14, 2001.
- [2] F. Bernhart. Catalan, Motzkin, and Riordan numbers. *Discrete Mathematics*, 204(1-3):73–112, 1999.
- [3] J. Berstel, L. Boasson, O. Carton and I. Fagnot. Sturmian trees. *Theory of Computing Systems*, 46(3): 443–478, 2010.
- [4] V. Berthé and M. Rigo. *Combinatorics, Automata and Number Theory*. Encyclopedia of Mathematics and its Applications, Cambridge, 2010.
- [5] M. Bousquet-Mélou. Algebraic generating functions in enumerative combinatorics and context-free languages. In: V. Diekert and B. Durand, editors, *STACS 2005*, volume 3404 of *Lecture Notes in Computer Science*, pages 18–35, Springer, Heidelberg, 2005.
- [6] P. Brändén and T. Mansour. Finite automata and pattern avoidance in words. *Journal of Combinatorial Theory, Series A*, 110(1):127–145, 2005.
- [7] W. Chen, S. Yan, and L. Yang. Identities from weighted Motzkin paths. *Advances in Applied Mathematics*, 41(3): 329–334, 2008.

- [8] M. Delest. Algebraic languages: a bridge between combinatorics and computer science. *DIMACS Series in Discrete Mathematics and Theoretical Computer Science*, 24: 71–88, 1996.
- [9] E. Deutsch, E. Munarini and S. Rinaldi. Skew Dyck paths. *Journal of Statistical Planning and Inference*, 140(8): 2191–2203, (2010).
- [10] E. Deutsch and L. Shapiro. A bijection between ordered trees and 2-Motzkin paths and its many consequences. *Discrete Mathematics*, 256(3): 655–670, 2002.
- [11] M. Droste, W. Kuich and H. Vogler. *Handbook of Weighted Automata*, first edition, Springer, Monographs in Theoretical Computer Science, 2009.
- [12] P. Flajolet. Combinatorial aspects of continued fractions. *Discrete Mathematics*, 32(2):125–161, 1980.
- [13] P. Flajolet and R. Sedgewick. *Analytic Combinatorics*, Cambridge, 2009.
- [14] R. Graham, M. Grötschel and L. Lovász. *Handbook of Combinatorics*, volume 2, MIT Press, Cambridge, 1995.
- [15] R. Graham, D. Knuth and O. Patashnik. *Concrete Mathematics*, second edition, Addison-Wesley, 1994.
- [16] S. Heubach and T. Mansour. *Combinatorics of Set Partitions*. Discrete Mathematics and its Applications, CRC Press, 2012.
- [17] A. Lascoux. *Symmetric Functions and Combinatorial Operators on Polynomials*. CBMS Regional Conference Series in Mathematics, American Mathematical Society, 2003.
- [18] T. Mansour. *Combinatorics of Compositions and Words*. Discrete Mathematics and its Applications, CRC Press, 2010.
- [19] T. Noe. On the Divisibility of Generalized Central Trinomial Coefficients. *Journal of Integer Sequences*, 9 Article 06.2.7.: 2006.
- [20] J. J. M. M. Rutten. Coinductive counting with weighted automata. *Journal of Automata, Languages and Combinatorics*, 8(2): 319–352, 2003.
- [21] J. Sakarovitch. *Elements of Automata Theory*, Cambridge, 2009.
- [22] A. Sapounakis and P. Tsikouras. On k-colored Motzkin words. *Journal of Integer Sequences*, 7 Article 04.2.5. 2004.
- [23] J. Shallit. *A Second Course in Formal Languages and Automata Theory*. Cambridge, 2009.
- [24] L. Shapiro and C. Wang. A Bijection Between 3-Motzkin Paths and Schröder Paths With No Peak at Odd Height. *Journal of Integer Sequences*, 12 Article 09.3.2.: 2009.
- [25] N. J. A. Sloane. *The On-Line Encyclopedia of Integer Sequences*. <https://oeis.org/>.
- [26] K. Uchimura. Properties of structure generating functions of automata and their applications for linear systems. *Theoretical Computer Science*, 18(2): 207–220, 1982.
- [27] K. Uchimura. Truncations of infinite matrices and algebraic series with some CF grammars. *Theoretical Computer Science*, 31(39): 227–261, 1984.
- [28] W. Wen-Jin. Animals and 2-Motzkin Paths. *Journal of Integer Sequences*, 8 Article 05.5.6.: 2005.

DEPARTAMENTO DE MATEMÁTICAS, UNIVERSIDAD NACIONAL DE COLOMBIA, BOGOTÁ, COLOMBIA
E-mail address: rdecastrok@unal.edu.co

DEPARTAMENTO DE MATEMÁTICAS, UNIVERSIDAD NACIONAL DE COLOMBIA, BOGOTÁ, COLOMBIA
E-mail address: andres1729@yahoo.com

INSTITUTO DE MATEMÁTICAS Y SUS APLICACIONES, UNIVERSIDAD SERGIO ARBOLEDA, BOGOTÁ, COLOMBIA, AND , DEPARTAMENTO DE MATEMÁTICAS, UNIVERSIDAD NACIONAL DE COLOMBIA, BOGOTÁ, COLOMBIA

E-mail address: josel.ramirez@ima.usergioarboleda.edu.co

URL: <http://sites.google.com/site/ramirezrjl>