

Congruence lattices of finite diagram monoids

James East*, James D. Mitchell†, Nik Ruškuc‡, Michael Torpey†

Abstract

We give a complete description of the congruence lattices of the following finite diagram monoids: the partition monoid, the planar partition monoid, the Brauer monoid, the Jones monoid (also known as the Temperley-Lieb monoid), the Motzkin monoid, and the partial Brauer monoid. All the congruences under discussion arise as special instances of a new construction, involving an ideal I , a retraction $I \rightarrow M$ onto the minimal ideal, a congruence on M , and a normal subgroup of a maximal subgroup outside I .

Keywords: diagram monoids, partition monoids, Brauer monoids, planar monoids, Jones monoids, Motzkin monoids, congruences.

MSC: 20M20, 08A30.

1 Introduction

A congruence on a semigroup S is an equivalence relation that is compatible with the multiplicative structure of S . The role played by congruences in semigroup theory (and general algebra) is analogous to that of normal subgroups in group theory, and ideals in ring theory: they are precisely the kernels of homomorphisms, and they govern the formation of quotients. The set $\text{Cong}(S)$ of all congruences of a semigroup S forms an (algebraic) lattice under inclusion, known as the congruence lattice of S .

The study of congruences has always been one of the corner-stones of semigroup theory, and a major strand in this direction has been the description of the congruence lattices of specific semigroups or families of semigroups. In his influential 1952 article [24], Mal'cev described the congruences on the full transformation monoid \mathcal{T}_n . Analogues for other classical monoids followed: the monoid of $n \times n$ matrices over a field (Mal'cev [25]), the symmetric inverse monoid \mathcal{I}_n (Liber [23]), the partial transformation semigroup \mathcal{PT}_n (Sutov [35]), and many others subsequently; see for example [2, 14, 27, 36]. A contemporary account of these results for \mathcal{T}_n , \mathcal{PT}_n , and \mathcal{I}_n can be found in [16, Section 6.3]. It turns out that, in each of these cases, the congruence lattice is a chain whose length is a linear function of n . An even more recent work is the paper [3] by Araújo, Bentz and Gomes, describing the congruences in various direct products of transformation monoids.

In the current article, we undertake a study of congruence lattices of diagram monoids. These monoids arise naturally in the study of diagram algebras, a class of algebras with origins in theoretical physics and representation theory. Key examples are the Temperley-Lieb algebras [5, 28, 37], Brauer algebras [6, 30], partition algebras [17, 20, 28] and Motzkin algebras [4]. These diagram algebras are defined by means of diagrammatic basis elements, and are all twisted semigroup algebras [38] of a corresponding diagram monoid, such as the Jones, Brauer, partition or Motzkin monoid; see Section 2 for the definitions of these monoids and others.

There are many important connections between diagram and transformation monoids. For one thing, the partition monoid \mathcal{P}_n contains copies of the full transformation monoid \mathcal{T}_n and the symmetric inverse monoid \mathcal{I}_n . In addition, many of the semigroup-theoretic properties of transformation monoids also hold for diagram monoids. For example, in each of the above-mentioned diagram monoids, the ideals form a chain with respect to containment. Furthermore, the idempotent-generated subsemigroup coincides with the singular part of the Brauer and partition monoids [11, 26], and the proper ideals of the Jones, Brauer and partition monoids are idempotent-generated [13]. When it comes to congruences, however, it turns out that the parallels are simultaneously less tight and more subtle.

This paper arose as a consequence of some initial computational experiments with the Semigroups package for the computer algebra system GAP [32]. Using newly developed algorithms for working with congruences, we were able to compute the congruence lattices of several diagram monoids, including the

*Centre for Research in Mathematics, School of Computing, Engineering and Mathematics, Western Sydney University, Locked Bag 1797, Penrith NSW 2751, Australia. *Email:* j.east@westernsydney.edu.au

†Mathematical Institute, School of Mathematics and Statistics, University of St Andrews, St Andrews, Fife KY16 9SS, UK. *Emails:* jdm3@st-andrews.ac.uk, nik.ruskuc@st-andrews.ac.uk, mct25@st-andrews.ac.uk

partition, Brauer and Jones monoids of relatively low degree. The results of these computations were surprising at the time. While the congruence lattices of the transformation monoids \mathcal{T}_n , \mathcal{PT}_n and \mathcal{I}_n are all finite chains, the congruence lattices of the diagram monoids have a richer structure, and contain a number of congruences identifying partitions of low rank in non-trivial ways. The computational experiments allowed us to develop a number of conjectures, and we originally proved these with a series of separate arguments for each of the monoids. Deeper analysis of these arguments led us to develop the theoretical framework presented in Section 3, which underpins all of the congruence lattices studied here, ultimately leading to the present article.

The exposition is organised as follows. In Section 2, we give the definitions and background material we require. In Section 3, we present a number of constructions that build congruences on a finite semigroup from ideals, retractions, maximal subgroups and congruences on the minimal ideal. It turns out that all of the congruences of the diagram and transformation monoids above are special instances of this construction. In Section 4, we present the known classifications of congruences on the symmetric inverse monoid \mathcal{I}_n (Liber [23]) and the monoid \mathcal{O}_n of order-preserving partial permutations of an n -element chain (Fernandes [14]), but couched in the framework established in Section 3. The rest of the paper is devoted to the presentation of the main results, treating each of the diagram monoids in turn. Section 5 concerns the partition monoid \mathcal{P}_n , and serves as a case study in applying our construction. In Section 6, we give a brief treatment of the case of the partial Brauer monoid \mathcal{PB}_n , which turns out to be a nearly verbatim re-run of the argument for \mathcal{P}_n . Section 7 covers the planar partition monoid \mathcal{PP}_n and the Motzkin monoid \mathcal{M}_n in parallel, and then in Sections 8 and 9, we consider the Brauer and Jones monoids \mathcal{B}_n and \mathcal{J}_n , respectively. The main results are stated in Theorems 5.4, 6.1, 7.3, 8.4 and 9.1. Depictions of the various congruence lattices may be found in Figures 4, 5, 7 and 9.

2 Preliminaries

In this section we introduce the partition monoids \mathcal{P}_n (Subsection 2.1) and a number of distinguished submonoids of \mathcal{P}_n (Subsection 2.2), and then discuss their Green's relations and ideals (Subsection 2.3). We conclude the section with a brief general discussion of congruences and their lattices in general (Subsection 2.4).

2.1 Partition monoids

Let n be a positive integer. Throughout the article, we write $\mathbf{n} = \{1, \dots, n\}$ and $\mathbf{n}' = \{1', \dots, n'\}$. The *partition monoid of degree n* , denoted \mathcal{P}_n , is the monoid of all set partitions of $\mathbf{n} \cup \mathbf{n}'$ under a product described below. That is, an element of \mathcal{P}_n is a set $\alpha = \{A_1, \dots, A_k\}$, for some k , where the A_i are pairwise disjoint nonempty subsets of $\mathbf{n} \cup \mathbf{n}'$ whose union is all of $\mathbf{n} \cup \mathbf{n}'$; the A_i are called the *blocks* of α .

A partition $\alpha \in \mathcal{P}_n$ may be represented as any graph with vertex set $\mathbf{n} \cup \mathbf{n}'$ with edges so that the connected components of the graph correspond to the blocks of the partition; such a graph is drawn with vertices $1, \dots, n$ on an upper row (increasing from left to right), with vertices $1', \dots, n'$ directly below, and with all edges within the rectangle determined by the vertices. For example, the partitions

$$\alpha = \{\{1, 4\}, \{2, 3, 4', 5'\}, \{5, 6\}, \{1', 2', 6'\}, \{3'\}\} \quad \text{and} \quad \beta = \{\{1, 2\}, \{3, 4, 1'\}, \{5, 4', 5', 6'\}, \{6\}, \{2'\}, \{3'\}\}$$

from \mathcal{P}_6 are pictured in Figure 1. As usual, we will identify a partition with any graph representing it.

The product of two partitions $\alpha, \beta \in \mathcal{P}_n$ is defined as follows. Write $\mathbf{n}'' = \{1'', \dots, n''\}$. Let α^\vee be the graph obtained from α by changing the label of each lower vertex i' to i'' , and let β^\wedge be the graph obtained from β by changing the label of each upper vertex i to i'' . Consider now the graph $\Pi(\alpha, \beta)$ on the vertex set $\mathbf{n} \cup \mathbf{n}' \cup \mathbf{n}''$ obtained by joining α^\vee and β^\wedge together so that each lower vertex i'' of α^\vee is identified with the corresponding upper vertex i'' of β^\wedge . We call $\Pi(\alpha, \beta)$ the *product graph* of α and β . We define $\alpha\beta \in \mathcal{P}_n$ to be the partition satisfying the property that $x, y \in \mathbf{n} \cup \mathbf{n}'$ belong to the same block of $\alpha\beta$ if and only if x and y are connected by a path in $\Pi(\alpha, \beta)$. This process is illustrated in Figure 1. The operation is associative and the partition $\text{id}_n = \{\{1, 1'\}, \dots, \{n, n'\}\}$ is the identity element, so \mathcal{P}_n is a monoid. It is worth noting that even though elements of \mathcal{P}_n naturally correspond to binary relations (indeed, equivalences) on a set of size $2n$, the product on \mathcal{P}_n does not correspond to composition of binary relations.

A block A of a partition is referred to as a *transversal* if $A \cap \mathbf{n} \neq \emptyset$ and $A \cap \mathbf{n}' \neq \emptyset$, or a *non-transversal* otherwise. If $\alpha \in \mathcal{P}_n$, we will write

$$\alpha = \left(\begin{array}{c|ccc|ccc} A_1 & \cdots & A_q & C_1 & \cdots & C_r \\ B_1 & \cdots & B_q & D_1 & \cdots & D_s \end{array} \right)$$

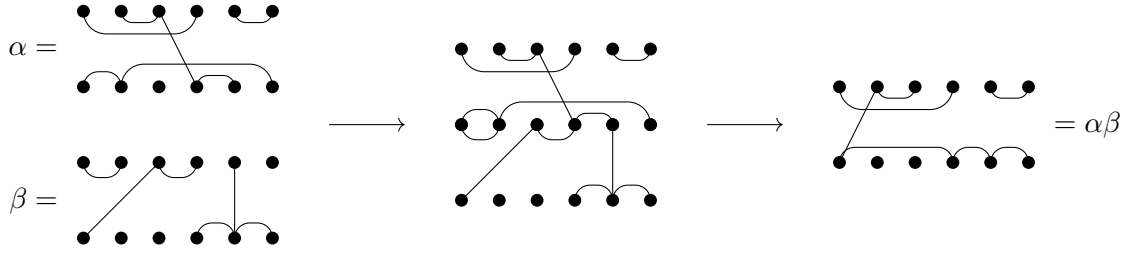

Figure 1: Two partitions $\alpha, \beta \in \mathcal{P}_6$ (left), the product graph $\Pi(\alpha, \beta)$ (middle), and their product $\alpha\beta \in \mathcal{P}_6$ (right).

to indicate that α has transversals $A_i \cup B'_i$ ($1 \leq i \leq q$), upper non-transversals C_j ($1 \leq j \leq r$) and lower non-transversals D'_k ($1 \leq k \leq s$). Note here that all of the sets A_i, B_i, C_j, D_k are contained in \mathbf{n} . For example, $\alpha \in \mathcal{P}_6$ defined above has $\{2, 3, 4', 5'\}$ as its only transversal, and has upper non-transversals $\{1, 4\}$ and $\{5, 6\}$, and lower non-transversals $\{1', 2', 6'\}$ and $\{3'\}$, so $\alpha = \left(\begin{array}{c|c|c|c} 2, 3 & 1, 4 & 5, 6 \\ \hline 4, 5 & 1, 2, 6 & 3 \end{array} \right)$. Note that in the expression $\alpha = \left(\begin{array}{c|c|c|c} A_1 & \dots & A_q & C_1 & \dots & C_r \\ \hline B_1 & \dots & B_q & D_1 & \dots & D_s \end{array} \right)$, the parameters r and s need not be equal, and that any (but not all) of q, r, s can be 0.

The (co)domain, (co)kernel and rank of a partition $\alpha = \left(\begin{array}{c|c|c|c} A_1 & \dots & A_q & C_1 & \dots & C_r \\ \hline B_1 & \dots & B_q & D_1 & \dots & D_s \end{array} \right) \in \mathcal{P}_n$ are defined as follows:

- $\text{dom}(\alpha) = A_1 \cup \dots \cup A_q = \{i \in \mathbf{n} : i \text{ belongs to a transversal of } \alpha\}$,
- $\text{codom}(\alpha) = B_1 \cup \dots \cup B_q = \{i \in \mathbf{n} : i' \text{ belongs to a transversal of } \alpha\}$,
- $\text{ker}(\alpha) = \{(i, j) \in \mathbf{n} \times \mathbf{n} : i \text{ and } j \text{ belong to the same block of } \alpha\}$, the equivalence relation on \mathbf{n} with equivalence classes $A_1, \dots, A_q, C_1, \dots, C_r$,
- $\text{coker}(\alpha) = \{(i, j) \in \mathbf{n} \times \mathbf{n} : i' \text{ and } j' \text{ belong to the same block of } \alpha\}$, the equivalence relation on \mathbf{n} with equivalence classes $B_1, \dots, B_q, D_1, \dots, D_s$,
- $\text{rank}(\alpha) = q$, the number of transversals of α .

For example, when $\alpha = \left(\begin{array}{c|c|c} 2, 3 & 1, 4 & 5, 6 \\ \hline 4, 5 & 1, 2, 6 & 3 \end{array} \right)$, we have $\text{rank}(\alpha) = 1$, $\text{dom}(\alpha) = \{2, 3\}$, $\text{codom}(\alpha) = \{4, 5\}$, the $\text{ker}(\alpha)$ -classes are $\{1, 4\}, \{2, 3\}, \{5, 6\}$, and the $\text{coker}(\alpha)$ -classes are $\{1, 2, 6\}, \{3\}, \{4, 5\}$.

One may easily check that for any $\alpha, \beta, \gamma \in \mathcal{P}_n$,

$$\begin{aligned} \text{dom}(\alpha\beta) &\subseteq \text{dom}(\alpha), & \text{codom}(\alpha\beta) &\subseteq \text{codom}(\beta), \\ \text{ker}(\alpha\beta) &\supseteq \text{ker}(\alpha), & \text{coker}(\alpha\beta) &\supseteq \text{coker}(\beta), & \text{rank}(\alpha\beta\gamma) &\leq \text{rank}(\beta). \end{aligned}$$

The group of units of \mathcal{P}_n is the set $\{\alpha \in \mathcal{P}_n : \text{rank}(\alpha) = n\}$; this group is isomorphic to (and will be identified with) the symmetric group \mathcal{S}_n .

The partition monoid admits a natural anti-involution $*$: $\mathcal{P}_n \rightarrow \mathcal{P}_n$ defined by

$$\left(\begin{array}{c|c|c|c} A_1 & \dots & A_q & C_1 & \dots & C_r \\ \hline B_1 & \dots & B_q & D_1 & \dots & D_s \end{array} \right)^* = \left(\begin{array}{c|c|c|c} B_1 & \dots & B_q & D_1 & \dots & D_s \\ \hline A_1 & \dots & A_q & C_1 & \dots & C_r \end{array} \right).$$

Roughly speaking, if $\alpha \in \mathcal{P}_n$, then α^* is obtained by reflecting (a graph representing) α in the horizontal axis midway between the two rows of vertices. It is easy to see that

$$\alpha^{**} = \alpha, \quad (\alpha\beta)^* = \beta^* \alpha^*, \quad \alpha \alpha^* \alpha = \alpha,$$

for all $\alpha, \beta \in \mathcal{P}_n$. It follows that \mathcal{P}_n is a *regular *-semigroup*, in the sense of Nordahl and Scheiblich [33], with respect to this operation. We have several obvious identities, such as $\text{dom}(\alpha^*) = \text{codom}(\alpha)$ and $\text{ker}(\alpha^*) = \text{coker}(\alpha)$. This symmetry/duality will allow us to shorten several proofs.

2.2 Other diagram monoids

In this subsection, we introduce a number of important submonoids of the partition monoid \mathcal{P}_n . Following [31], the *Brauer* and *partial Brauer monoid* are defined by

$$\mathcal{B}_n = \{\alpha \in \mathcal{P}_n : \text{all blocks of } \alpha \text{ have size } 2\} \quad \text{and} \quad \mathcal{PB}_n = \{\alpha \in \mathcal{P}_n : \text{all blocks of } \alpha \text{ have size at most } 2\},$$

respectively. Note that $\mathcal{S}_n \subsetneq \mathcal{B}_n \subsetneq \mathcal{PB}_n \subsetneq \mathcal{P}_n$. Note also that an element of \mathcal{PB}_n has a *unique* representation as a graph with no loops or multiple edges and with vertex set $\mathbf{n} \cup \mathbf{n}'$.

Following [20], we say that a partition $\alpha \in \mathcal{P}_n$ is *planar* if it has a graphical representation where the edges are drawn within the rectangle spanned by the vertices and do not intersect. For example, with $\alpha, \beta \in \mathcal{P}_6$ as in Figure 1, β is planar but α is not. The set \mathcal{PP}_n of all planar partitions is clearly a submonoid of \mathcal{P}_n . The *Jones* and *Motzkin monoids* are defined by

$$\mathcal{J}_n = \mathcal{B}_n \cap \mathcal{PP}_n \quad \text{and} \quad \mathcal{M}_n = \mathcal{PB}_n \cap \mathcal{PP}_n;$$

see [18, 21]. It is well known [17, 20] that \mathcal{PP}_n is isomorphic to \mathcal{J}_{2n} ; see for example [17, p873]. We will have more to say about this isomorphism in Section 9, where it will play a crucial role in our analysis of the even degree Jones monoids \mathcal{J}_{2n} .

The partition monoid \mathcal{P}_n contains a number of other submonoids arising from the theory of *transformation monoids*. Of particular importance to us here are:

- $\mathcal{I}_n = \{\alpha \in \mathcal{PB}_n : \text{every non-transversal of } \alpha \text{ is a singleton}\}$, which is isomorphic to (and will be identified with) the *symmetric inverse monoid*, consisting of all partial permutations of \mathbf{n} ;
- $\mathcal{O}_n = \mathcal{I}_n \cap \mathcal{PP}_n = \mathcal{I}_n \cap \mathcal{M}_n$, the monoid of all order-preserving partial permutations of \mathbf{n} .

It is clear that $\mathcal{I}_n \cap \mathcal{B}_n = \mathcal{S}_n$. The submonoids of \mathcal{P}_n defined above— $\mathcal{P}_n, \mathcal{PB}_n, \mathcal{PP}_n, \mathcal{B}_n, \mathcal{I}_n, \mathcal{M}_n, \mathcal{S}_n, \mathcal{J}_n$ and \mathcal{O}_n —are pictured in Figure 2, which displays their inclusions, intersections, and representative elements. Each of these monoids is closed under the operation $*$ defined above.

The full transformation monoid \mathcal{T}_n is also naturally contained as a submonoid of \mathcal{P}_n , as the set of all $\alpha \in \mathcal{P}_n$ with $\text{dom}(\alpha) = \mathbf{n}$ and $\text{coker}(\alpha)$ equal to the trivial relation on \mathbf{n} . However \mathcal{T}_n does not play a role in this paper, and so it is not included in Figure 2. We also note that the partial transformation monoid \mathcal{PT}_n does not (naturally) embed as a submonoid of \mathcal{P}_n ; see [10, Section 3.2].

It will be convenient to have a special notation for the elements of \mathcal{I}_n . The unique element $\alpha \in \mathcal{I}_n$ with transversals $\{a_1, b'_1\}, \dots, \{a_q, b'_q\}$ will be denoted by $\alpha = \begin{bmatrix} a_1 & \dots & a_q \\ b_1 & \dots & b_q \end{bmatrix}$. With this notation, we have $\alpha^{-1} = \alpha^* = \begin{bmatrix} b_1 & \dots & b_q \\ a_1 & \dots & a_q \end{bmatrix}$. As a special case, when $\alpha = \{\{1\}, \dots, \{n\}, \{1'\}, \dots, \{n'\}\}$ is the unique element of \mathcal{I}_n with no transversals, we write $\alpha = [\emptyset]$.

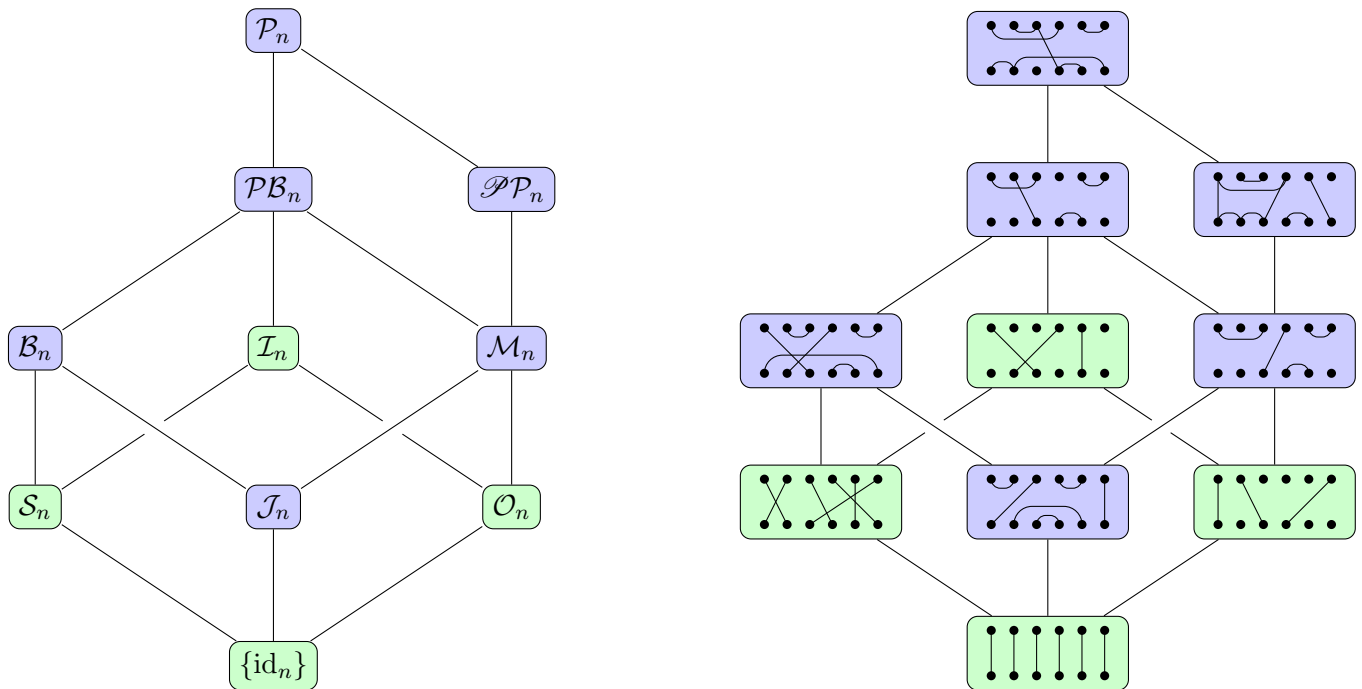

Figure 2: Important submonoids of \mathcal{P}_n (left) and representative elements from each submonoid (right). The congruence lattices are already known for the monoids shaded green (see Section 4); in this article, we describe the congruence lattices for all the other monoids.

2.3 Green's equivalences and ideals of diagram monoids

Green's equivalences \mathcal{R} , \mathcal{L} , \mathcal{J} , \mathcal{H} and \mathcal{D} reflect the ideal structure of a semigroup S , and are the fundamental structural tool in semigroup theory. They are defined as follows. We write $S^1 = S$ if S is a monoid; otherwise S^1 is the monoid obtained from S by adjoining an identity element to S . Then, for $a, b \in S$,

$$a \mathcal{R} b \Leftrightarrow aS^1 = bS^1, \quad a \mathcal{L} b \Leftrightarrow S^1a = S^1b, \quad a \mathcal{J} b \Leftrightarrow S^1aS^1 = S^1bS^1;$$

further, $\mathcal{H} = \mathcal{R} \cap \mathcal{L}$, and \mathcal{D} is the join $\mathcal{R} \vee \mathcal{L}$: i.e., the least equivalence containing \mathcal{R} and \mathcal{L} . It is well known that $\mathcal{D} = \mathcal{R} \circ \mathcal{L} = \mathcal{L} \circ \mathcal{R}$ for any semigroup S , and that $\mathcal{D} = \mathcal{J}$ when S is finite (as is the case for all semigroups considered in this article). If \mathcal{K} is any of Green's relations, and if $a \in S$, we write $K_a = \{b \in S : a \mathcal{K} b\}$ for the \mathcal{K} -class of a in S . The set $S/\mathcal{J} = \{J_a : a \in S\}$ of all \mathcal{J} -classes of S is partially ordered as follows. For $a, b \in S$, we say that $J_a \leq J_b$ if $a \in S^1bS^1$. If T is a subset of S that is a union of \mathcal{J} -classes, we write T/\mathcal{J} for the set of all \mathcal{J} -classes of S contained in T . The reader is referred to [19, Chapter 2] or [34, Appendix A] for a more detailed introduction to Green's relations.

Green's equivalences on all diagram monoids considered in this article are governed by (co)domains, (co)kernels and ranks, as specified in the following proposition. For \mathcal{P}_n this was first proved in [38], though the terminology there was different. For the other monoids see [9, Theorem 2.4] and also [14–16, 38]. The proposition will be used frequently throughout the paper without explicit reference.

Proposition 2.1. *Let \mathcal{K}_n be any of the monoids $\mathcal{P}_n, \mathcal{PB}_n, \mathcal{B}_n, \mathcal{PP}_n, \mathcal{M}_n, \mathcal{I}_n, \mathcal{J}_n, \mathcal{O}_n$. If $\alpha, \beta \in \mathcal{K}_n$, then*

- (i) $\alpha \mathcal{R} \beta \Leftrightarrow \text{dom}(\alpha) = \text{dom}(\beta)$ and $\ker(\alpha) = \ker(\beta)$,
- (ii) $\alpha \mathcal{L} \beta \Leftrightarrow \text{codom}(\alpha) = \text{codom}(\beta)$ and $\text{coker}(\alpha) = \text{coker}(\beta)$,
- (iii) $\alpha \mathcal{J} \beta \Leftrightarrow \alpha \mathcal{D} \beta \Leftrightarrow \text{rank}(\alpha) = \text{rank}(\beta)$,
- (iv) $J_\alpha \leq J_\beta \Leftrightarrow \text{rank}(\alpha) \leq \text{rank}(\beta)$. □

Remark 2.2. A number of consequences and simplifications arise from Proposition 2.1. We list them here, again to be used throughout, usually without explicit reference.

- (i) If α, β belong to any of the monoids we consider, then $\alpha \mathcal{R} \beta$ (respectively, $\alpha \mathcal{L} \beta$, $\alpha \mathcal{J} \beta$, $\alpha \mathcal{H} \beta$) if and only if $\alpha^* \mathcal{L} \beta^*$ (respectively, $\alpha^* \mathcal{R} \beta^*$, $\alpha^* \mathcal{J} \beta^*$, $\alpha^* \mathcal{H} \beta^*$).
- (ii) Elements of \mathcal{I}_n have trivial (co)kernels, so

$$\alpha \mathcal{R} \beta \Leftrightarrow \text{dom}(\alpha) = \text{dom}(\beta) \quad \text{and} \quad \alpha \mathcal{L} \beta \Leftrightarrow \text{codom}(\alpha) = \text{codom}(\beta) \quad \text{for } \alpha, \beta \in \mathcal{I}_n \text{ or } \mathcal{O}_n.$$
- (iii) The (co)domain of an element of \mathcal{B}_n is completely determined by its (co)kernel, so

$$\alpha \mathcal{R} \beta \Leftrightarrow \ker(\alpha) = \ker(\beta) \quad \text{and} \quad \alpha \mathcal{L} \beta \Leftrightarrow \text{coker}(\alpha) = \text{coker}(\beta) \quad \text{for } \alpha, \beta \in \mathcal{B}_n \text{ or } \mathcal{J}_n.$$
- (iv) \mathcal{H} is the trivial relation on $\mathcal{PP}_n, \mathcal{M}_n, \mathcal{J}_n$ and \mathcal{O}_n .
- (v) The \mathcal{J} -classes in all the monoids under consideration are in one-one correspondence with the available ranks. In $\mathcal{P}_n, \mathcal{PB}_n, \mathcal{PP}_n, \mathcal{M}_n, \mathcal{I}_n, \mathcal{O}_n$, there is a \mathcal{J} -class for every $r \in \{0, \dots, n\}$ and in $\mathcal{B}_n, \mathcal{J}_n$ for every $r \in \{0, \dots, n\}$ with $r \equiv n \pmod{2}$.
- (vi) All \mathcal{J} -classes in all these monoids are regular: equivalently, every \mathcal{J} -class contains an idempotent.
- (vii) The maximal subgroup (i.e., group \mathcal{H} -class) containing an idempotent of rank r is isomorphic to \mathcal{S}_r in $\mathcal{P}_n, \mathcal{PB}_n, \mathcal{B}_n, \mathcal{I}_n$, and is trivial in $\mathcal{PP}_n, \mathcal{M}_n, \mathcal{J}_n, \mathcal{O}_n$.
- (viii) All of Green's relations coincide with the universal relation on \mathcal{S}_n , or indeed on any group.

Let $\mathcal{K}_n \in \{\mathcal{P}_n, \mathcal{PB}_n, \mathcal{B}_n, \mathcal{PP}_n, \mathcal{M}_n, \mathcal{I}_n, \mathcal{J}_n, \mathcal{O}_n\}$. We will denote the \mathcal{J} -class of \mathcal{K}_n of partitions $\alpha \in \mathcal{K}_n$ with $\text{rank}(\alpha) = r$ by $J_r(\mathcal{K}_n)$, or, if there is no danger of confusion, simply by J_r . Corresponding to J_r is the ideal $I_r = I_r(\mathcal{K}_n) = \{\alpha \in \mathcal{K}_n : \text{rank}(\alpha) \leq r\}$. Since the \mathcal{J} -classes of \mathcal{K}_n form a chain under the ordering discussed above, the ideals of \mathcal{K}_n are precisely the sets I_r , and these form a chain under inclusion [9, Proposition 2.6].

The structure of the minimal ideal will turn out to have a commanding influence on the congruence lattice of individual diagram monoids. In almost all of the above monoids, the minimal ideal is $I_0 = J_0$, the set of all elements of rank 0. The only two exceptions are \mathcal{B}_n and \mathcal{J}_n for n odd, where the minimal ideal is $I_1 = J_1$. In each case the minimal ideal consists entirely of idempotents: i.e., it is a rectangular band. Furthermore, the minimal ideal is $\{[\emptyset]\}$ in \mathcal{I}_n and \mathcal{O}_n , but in every other case it contains multiple \mathcal{R} - and \mathcal{L} -classes, with trivial exceptions for small n . It will transpire in the course of the paper that this is precisely the cause behind the non-linear structure of the congruence lattice.

2.4 Congruence lattices

Recall that an equivalence relation ξ on a semigroup S is a *right congruence* if, for all $a, b, x \in S$, $(a, b) \in \xi$ implies $(ax, bx) \in \xi$. *Left congruences* are defined analogously. A relation on S is a *congruence* if it is a left and right congruence. The *join* of two equivalence relations ξ, ζ on the same set is the smallest equivalence relation containing $\xi \cup \zeta$; we denote this by $\xi \vee \zeta$. The join of two congruences on a semigroup is also a congruence, and so too is the intersection. The set $\text{Cong}(S)$ of all congruences on S forms a lattice, known as the *congruence lattice of S* , under the operations of intersection and join. The maximum and minimum elements of $\text{Cong}(S)$ are the *universal congruence* $\nabla_S = S \times S$, and the *trivial congruence* $\Delta_S = \{(a, a) : a \in S\}$, respectively.

If $\Omega \subseteq S \times S$, we write $\Omega_S^\#$ (or just $\Omega^\#$ if S is understood from context) for the congruence on S generated by Ω : that is, the smallest congruence on S containing Ω . So $\Omega_S^\#$ is the least equivalence on S containing the set $\{(axb, ayb) : (x, y) \in \Omega, a, b \in S^1\}$; see for example [19, Section 1.5]. In the special case that $\Omega = \{(x, y)\}$ consists of a single pair, we will write $(x, y)_S^\# = \Omega_S^\#$; such a congruence is called *principal*. Clearly, every congruence is a (possibly infinite) join of principal congruences.

If T is a subsemigroup of a semigroup S , then the congruence lattices $\text{Cong}(S)$ and $\text{Cong}(T)$ may be related in the following way. Any congruence ξ on S induces a congruence on T defined by $\xi^T = \xi \cap (T \times T)$. And any congruence ζ on T induces a congruence on S : namely, $\zeta_S^\#$, the congruence on S generated by ζ . So we have two maps

$$\Phi_{S,T} : \text{Cong}(S) \rightarrow \text{Cong}(T) : \xi \mapsto \xi^T \quad \text{and} \quad \Psi_{S,T} : \text{Cong}(T) \rightarrow \text{Cong}(S) : \zeta \mapsto \zeta_S^\#.$$

In general, neither map need be injective or surjective. Also, although both $\Phi_{S,T}$ and $\Psi_{S,T}$ preserve \subseteq , and although $\Phi_{S,T}$ preserves \cap , and $\Psi_{S,T}$ preserves \vee , neither $\Phi_{S,T}$ nor $\Psi_{S,T}$ need preserve all three of \subseteq , \cap and \vee . In other words, neither $\Phi_{S,T}$ nor $\Psi_{S,T}$ need be a lattice homomorphism. But we note that

$$\xi(\Phi_{S,T} \circ \Psi_{S,T}) \subseteq \xi \quad \text{and} \quad \zeta \subseteq \zeta(\Psi_{S,T} \circ \Phi_{S,T}) \quad \text{for all } \xi \in \text{Cong}(S) \text{ and } \zeta \in \text{Cong}(T).$$

The maps $\Phi_{S,T}$ and $\Psi_{S,T}$ will play an important role here, in that they will establish links between the different diagram monoids we consider: perhaps even more significantly, with the three monoids for which the congruence lattices are already known: namely, \mathcal{S}_n , \mathcal{I}_n and \mathcal{O}_n ; see Section 4.

Because of its inherent importance, the involution $\alpha \mapsto \alpha^*$ is sometimes given the status of an additional fundamental operation on a diagram monoid \mathcal{K}_n , turning the latter into a so-called **-semigroup*. In this context, a **-congruence* is a semigroup congruence ξ that additionally satisfies $(\alpha, \beta) \in \xi \Rightarrow (\alpha^*, \beta^*) \in \xi$. The set $\text{Cong}^*(\mathcal{K}_n)$ of all **-congruences* of \mathcal{K}_n is a sublattice of $\text{Cong}(\mathcal{K}_n)$.

3 Congruences from ideals, normal subgroups and retractions

This section is pivotal for the rest of the paper. In it, we introduce a number of constructions yielding families of congruences on certain classes of semigroups, including all finite semigroups. All of the congruences discussed in subsequent sections will be instances of these constructions. The Rees congruence associated to an ideal (Definition 3.1) can be viewed as a starting point for each construction. The key building blocks are what we shall call *retractable ideals* (Definition 3.2) and *lifting congruences* (Definition 3.6), and a certain relation associated to each normal subgroup of a maximal subgroup in a stable, regular \mathcal{J} -class (Definitions 3.9 and 3.14). For completeness, we recall the definition of a Rees congruence:

Definition 3.1. A non-empty subset I of a semigroup S is an *ideal* if $ax, xa \in I$ for all $x \in I$ and $a \in S$. To an ideal I , we associate the *Rees congruence* $R_I = \Delta_S \cup (I \times I)$.

Recall that a semigroup has at most one minimal ideal, and that if a minimal ideal exists, then it is a single \mathcal{J} -class and is the intersection of all ideals; see for example [19, Section 3.1]. Since the intersection of any finite collection of ideals is non-empty, every finite semigroup has a minimal ideal. Not every infinite semigroup has a minimal ideal, however; consider the natural numbers under addition, for example.

Definition 3.2. Let S be a semigroup with a minimal ideal M . An ideal I of S is *retractable* if there exists a homomorphism $f : I \rightarrow M$ such that $xf = x$ for all $x \in M$; such a homomorphism is called a *retraction*.

Clearly, if I, J are ideals of S with $I \subseteq J$ and J retractable, then I is also retractable. Also, note that if S has a zero element, then $\{0\}$ is the minimal ideal and all ideals are trivially retractable.

Before we describe the first congruence construction, we prove some preliminary results concerning retractions. Recall that an element x of a semigroup S is *regular* if there exists $y \in S$ such that $x = xyx$. Then with $a = yxy$, note that $x = xax$ and $a = axa$, and that xa and ax are idempotents of S with $x \mathcal{R} xa$ and $x \mathcal{L} ax$. We say a subset of S is regular if all its elements are regular. If any element of a \mathcal{D} -class of S is regular, then *every* element of the \mathcal{D} -class is regular, but this is not true of \mathcal{J} -classes in general; see [19, Proposition 2.3.1].

The next sequence of results concern semigroups with regular minimal ideals. Finite semigroups always have a regular minimal ideal; this is well known, and also follows from Lemma 3.11 below. On the other hand, infinite semigroups can have a non-regular minimal ideal; see [19, Chapter 2, Exercise 1].

Lemma 3.3. Let S be a semigroup with a regular minimal ideal M , and let I be an ideal of S . If $f : I \rightarrow M$ is a retraction, then $(sxt)f = s(xf)t$ for all $x \in I$ and $s, t \in S^1$.

Proof. We will prove the lemma by showing that $(sx)f = s(xf)$ for any $s \in S^1$ and $x \in I$. The equality $(xt)f = (xf)t$ is dual, and then $(sxt)f = s(xt)f = s(xf)t$. Let $e \in M$ be any right identity for xf ; such an e exists because M is regular. Then, since f is a retraction and $e, xe \in M$, we have $xf = (xf)e = (xf)(ef) = (xe)f = xe$. Next, let $e_1 \in M$ be a left identity for $(sx)f$. Then $(sx)fe = e_1(sx)fe = (e_1f)(sx)f(ef) = (e_1sxe)f = (e_1s)f(xf)(ef) = (e_1s)f(xf) = (e_1sx)f = (e_1f)(sx)f = e_1(sx)f = (sx)f$. So e is a right identity for $(sx)f$ as well, and hence $(sx)f = sxe = s(xf)$, as required. \square

Corollary 3.4. Let S be a semigroup with a regular minimal ideal M . If I is a retractable ideal of S , then there exists a unique retraction from I to M .

Proof. Suppose $f, g : I \rightarrow M$ are retractions, and let $x \in I$. Let $e \in M$ be a left identity for xf . Using Lemma 3.3, we see that $xf = e(xf) = (ex)f = ex = (ex)g = e(xg)$. A dual argument shows that $xg = (xf)e'$ for some e' . But then $xf = e(xg) = e(xf)e' = (xf)e' = xg$. \square

Although we will make no subsequent use of the next result, we believe it is of independent interest, and so include it for completeness.

Proposition 3.5. Let S be a semigroup with a regular minimal ideal M . Then the union of any non-empty family of retractable ideals of S is a retractable ideal. Consequently, S contains a unique maximal retractable ideal.

Proof. The second claim clearly follows from the first. Suppose $\{I_k : k \in K\}$ is a non-empty collection of retractable ideals of S , and put $I = \bigcup_{k \in K} I_k$; clearly I is an ideal of S . For each $k \in K$, let $f_k : I_k \rightarrow M$ be the unique retraction. For any non-empty subset $L \subseteq K$, define $I_L = \bigcap_{l \in L} I_l$. Since M is contained in each I_l , it follows that I_L is non-empty, and so an ideal of M . Furthermore, for any $l \in L$, the restriction of f_l to I_L is a retraction; thus, by Corollary 3.4, all such restrictions are equal. It follows that there is a well-defined map $f : I \rightarrow M$ defined, for $x \in I$, by $xf = xf_k$ if $x \in I_k$. Clearly f acts identically on M , so to complete the proof, it remains to show that $(xy)f = (xf)(yf)$ for all $x, y \in I$. With this in mind, suppose $x, y \in I$, and let $k, l \in K$ be such that $x \in I_k$ and $y \in I_l$. Then, using Lemma 3.3 and the facts that $xy \in I_l$ and $(xy)f_l \in M$, we have $(xf)(yf) = (xf_k)(yf_l) = (x(yf_l))f_k = ((xy)f_l)f_k = (xy)f_l = (xy)f$, as required. \square

Our first construction combines the idea of a retractable ideal with the following.

Definition 3.6. Let S be a semigroup with a minimal ideal M . A congruence ξ on M is a *lifting congruence* if any, and hence all, of the following equivalent conditions are satisfied:

- (i) $\Delta_S \cup \xi$ is a congruence on S , or
- (ii) there exists a congruence ζ on S such that $\xi = \zeta \cap (M \times M)$, or
- (iii) for all $(x, y) \in \xi$ and $s \in S$, $(xs, ys), (sx, sy) \in \xi$.

Definition 3.7. Let S be a semigroup with a minimal ideal M . To any retractable ideal I of S (Definition 3.2), and to any lifting congruence ξ on M (Definition 3.6), we associate the relation

$$\zeta_{I,\xi} = \Delta_S \cup \{(x, y) \in I \times I : (xf, yf) \in \xi\},$$

where $f : I \rightarrow M$ is the unique retraction.

Clearly the trivial and universal congruences, Δ_M and ∇_M on M , are lifting congruences: in particular, when $I = M$ is the minimal ideal itself, we have $\zeta_{M,\Delta_M} = \Delta_S$ and $\zeta_{M,\nabla_M} = R_M$. Note also that if ξ is a lifting congruence, and if I_1, I_2 are retractable ideals with $I_1 \subseteq I_2$, then $\zeta_{I_1,\xi} \subseteq \zeta_{I_2,\xi}$.

Proposition 3.8. *Let S be a semigroup with a regular minimal ideal M . If I is a retractable ideal of S , and ξ a lifting congruence on M , then the relation $\zeta_{I,\xi}$ is a congruence on S .*

Proof. Write $\zeta = \zeta_{I,\xi}$ for brevity, and let $f : I \rightarrow M$ be the retraction. Let $(x, y) \in \zeta$ and $s \in S$ be arbitrary. We must show that $(xs, ys), (sx, sy) \in \zeta$. This is clear if $x = y$, so suppose $x, y \in I$ and $xf \xi yf$. Since I is an ideal, we have $xs, ys \in I$. By Lemma 3.3, and condition (iii) of Definition 3.6, we have $(xs)f = (xf)s \xi (yf)s = (ys)f$, showing that $(xs, ys) \in \zeta$. A dual argument shows that $(sx, sy) \in \zeta$. \square

In general, the minimal ideal may have many congruences, only few of which are lifting congruences. In a full transformation semigroup \mathcal{T}_X , for example, the minimal ideal M consists of the constant transformations and is a right zero semigroup of size $|X|$. Hence, every equivalence relation on M is a congruence. On the other hand, for any $(f_1, f_2), (g_1, g_2) \in M \times M$ with $f_1 \neq f_2$ and $g_1 \neq g_2$ there exists $h \in \mathcal{T}_X$ such that $(f_1h, f_2h) = (g_1, g_2)$, and so the only lifting congruences on M are Δ_M and ∇_M .

In what follows, we will be mostly concerned with certain lifting congruences that exist in *every* finite semigroup, beyond the obvious Δ_M and ∇_M . These lifting congruences are present in many infinite semigroups as well; the key concept is *stability*.

Definition 3.9. A \mathcal{J} -class J of a semigroup S is *stable* if, for all $x \in J$ and $a \in S$,

$$xa \mathcal{J} x \Rightarrow xa \mathcal{R} x \quad \text{and} \quad ax \mathcal{J} x \Rightarrow ax \mathcal{L} x.$$

It is well known that every \mathcal{J} -class of a finite semigroup is stable; see for example [34, Theorem A.2.4]. We require two preliminary results concerning stability; Lemmas 3.10 and 3.11 are probably well known, but we include simple proofs for convenience. The proof of the next result utilises the partial order on \mathcal{J} -classes discussed in Section 2.3.

Lemma 3.10. *If J is a stable \mathcal{J} -class of a semigroup S , then J is a \mathcal{D} -class.*

Proof. Let $x, y \in J$. We must show that $x \mathcal{D} y$. Since $x \mathcal{J} y$, we have $y = axb$ for some $a, b \in S^1$. Then $J_y = J_{axb} \leq J_{ax} \leq J_x = J_y$, so that, in fact, all of these \mathcal{J} -classes are equal (to J). In particular, $ax \mathcal{J} x$ and $(ax)b \mathcal{J} ax$. Since $x, ax \in J$, it follows from stability that $ax \mathcal{L} x$, and $ax \mathcal{R} (ax)b = y$. Thus, $x \mathcal{L} ax \mathcal{R} y$, which gives $x \mathcal{D} y$. \square

As noted above, if a semigroup has a minimal ideal, then this ideal is a single \mathcal{J} -class. Recall that a semigroup is *completely regular* if it is a union of groups; in particular, any completely regular semigroup is regular. Recall that a *rectangular band* is a semigroup consisting of idempotents, all of which are \mathcal{D} -related.

Lemma 3.11. *Let S be a semigroup with a stable minimal ideal M . Then M is completely regular. In particular, if M is \mathcal{H} -trivial, then M is a rectangular band.*

Proof. Let $x \in M$. Since M is an ideal, $x^2 \in M$. Since M is a single \mathcal{J} -class, it follows that $x^2 \mathcal{J} x$. Stability then gives $x^2 \mathcal{R} x$ and $x^2 \mathcal{L} x$, so that $x^2 \mathcal{H} x$. Green's Theorem (see [19, Theorem 2.2.5]) then says that the \mathcal{H} -class of x is a group. This completes the proof of the first claim. The second follows from the first, together with the fact that M is a \mathcal{D} -class, which itself follows from Lemma 3.10. \square

As a consequence of Lemma 3.11, all the results above concerning semigroups with a *regular* minimal ideal apply to any semigroup with a *stable* minimal ideal; as noted above, this includes all finite semigroups. If \mathcal{K} is any of Green's relations on a semigroup S with a minimal ideal M , we denote by $\mathcal{K}^M = \mathcal{K} \cap (M \times M)$ the restriction of \mathcal{K} to M .

Lemma 3.12. *Let S be a semigroup with a stable minimal ideal M . Then \mathcal{L}^M , \mathcal{R}^M and \mathcal{H}^M are all lifting congruences on M .*

Proof. By duality, and since $\mathcal{H}^M = \mathcal{L}^M \cap \mathcal{R}^M$, it suffices to prove the result for \mathcal{L}^M . Let $(x, y) \in \mathcal{L}^M$ and $s \in S$. Since M is an ideal, $xs, ys, sx, sy \in M$. Since \mathcal{L} is a right congruence, it follows that $(xs, ys) \in \mathcal{L}$, and hence $(xs, ys) \in \mathcal{L}^M$. Since M is a single \mathcal{J} -class, $x \mathcal{J} sx$, and stability gives $x \mathcal{L} sx$; similarly, $y \mathcal{L} sy$. It follows that $sx \mathcal{L} x \mathcal{L} y \mathcal{L} sy$, and so $(sx, sy) \in \mathcal{L}^M$. \square

Lemma 3.12 does not hold for arbitrary semigroups. For example, the *bicyclic semigroup*, given by the presentation $\langle a, b : ba = 1 \rangle$, is \mathcal{J} -universal and so equal to its own minimal ideal. It is regular but not stable, and neither \mathcal{L} nor \mathcal{R} is a (lifting) congruence.

As a result of Proposition 3.8 and Lemma 3.12, we obtain the following family of congruences associated to an arbitrary retractable ideal in a semigroup with a stable minimal ideal.

Definition 3.13. Let S be a semigroup with a stable minimal ideal M . Given a retractable ideal I of S (Definition 3.2), define the congruences

$$\begin{aligned} \lambda_I &= \zeta_{I, \mathcal{L}^M} = \Delta_S \cup \{(x, y) \in I \times I : xf \mathcal{L} yf\}, & \mu_I &= \zeta_{I, \mathcal{H}^M} = \Delta_S \cup \{(x, y) \in I \times I : xf \mathcal{H} yf\}, \\ \rho_I &= \zeta_{I, \mathcal{R}^M} = \Delta_S \cup \{(x, y) \in I \times I : xf \mathcal{R} yf\}, & \eta_I &= \zeta_{I, \Delta_M} = \Delta_S \cup \{(x, y) \in I \times I : xf = yf\}, \end{aligned}$$

where $f : I \rightarrow M$ is the unique retraction, and where the relations $\zeta_{I, \xi}$ are as in Definition 3.7.

It is clear that $\eta_I \subseteq \mu_I = \lambda_I \cap \rho_I$, with $\eta_I = \mu_I$ if and only if M is \mathcal{H} -trivial, and that all four relations from Definition 3.13 are contained in $R_I = \zeta_{I, \nabla_M}$. It is also clear that if I_1, I_2 are retractable ideals with $I_1 \subseteq I_2$, then $R_{I_1} \subseteq R_{I_2}$, $\lambda_{I_1} \subseteq \lambda_{I_2}$, $\rho_{I_1} \subseteq \rho_{I_2}$, $\mu_{I_1} \subseteq \mu_{I_2}$ and $\eta_{I_1} \subseteq \eta_{I_2}$. Since M is a single \mathcal{D} -class (by Lemma 3.10), and since $\mathcal{D} = \mathcal{L} \vee \mathcal{R}$, it is easy to show that $R_I = \lambda_I \vee \rho_I$ (see also Propositions 3.25 and 3.27). If M is \mathcal{L} -trivial, then $\lambda_I = \mu_I = \eta_I$ and $R_I = \rho_I$; if M is \mathcal{L} -universal, then $\lambda_I = R_I$ and $\mu_I = \rho_I$.

The remaining families of congruences involve the interaction between an ideal and a stable, regular \mathcal{J} -class directly above it. Each will make use of the following auxiliary relation:

Definition 3.14. Suppose J is a stable, regular \mathcal{J} -class of a semigroup S . For a normal subgroup N of a maximal subgroup contained in J , define the relation

$$\nu_N = S^1(N \times N)S^1 \cap (J \times J) = \{(sxt, syt) \in J \times J : x, y \in N, s, t \in S^1\}.$$

An alternative, perhaps more intuitive, way of viewing the relation ν_N is as follows. Since J is stable and regular, the principal factor \bar{J} is a regular completely 0-simple semigroup and, hence, isomorphic to a Rees 0-matrix semigroup $\mathcal{M}^0[G; K, L; P]$, where G is the maximal subgroup of S containing N , and P is an $L \times K$ matrix over $G \cup \{0\}$. The natural epimorphism $G \rightarrow G/N$ induces an epimorphism $\mathcal{M}^0[G; K, L; P] \rightarrow \mathcal{M}^0[G/N; K, L; P/N]$, where P/N is obtained from P by replacing every entry by the coset it represents, whose kernel corresponds to a congruence $\bar{\nu}_N$ on \bar{J} . It is possible to show that $\nu_N = \bar{\nu}_N \cap (J \times J) = \bar{\nu}_N \setminus \{(0, 0)\}$. Since this observation is not crucial to our purposes, we omit the details.

Although the ν_N relation from Definition 3.14 could be defined for a normal subgroup N of *any* maximal subgroup, stability of the \mathcal{J} -class containing N is essential in showing that certain relations built from ν_N are in fact congruences; see Lemma 3.19 and Remark 3.21.

If J is a stable, regular \mathcal{J} -class of a semigroup S , then it is a \mathcal{D} -class by Lemma 3.10, so all maximal subgroups of S contained in J are isomorphic; see [19, Proposition 2.3.6]. The next result shows that all maximal subgroups in such a \mathcal{J} -class produce the same collection of ν_N relations; thus, in the applications that follow, we need only consider a single fixed maximal subgroup of each stable, regular \mathcal{J} -class.

Lemma 3.15. *Let G_1, G_2 be maximal subgroups contained in the same stable, regular \mathcal{J} -class J of a semigroup S . If N_1 is a normal subgroup of G_1 , then there exists a normal subgroup N_2 of G_2 such that $\nu_{N_1} = \nu_{N_2}$.*

Proof. By Lemma 3.10, J is a \mathcal{D} -class. By the proof of [19, Proposition 2.3.6], there exist $a, b \in S$ such that the map $\phi : G_1 \rightarrow G_2 : x \mapsto axb$ is an isomorphism, with inverse $x \mapsto bxa$. Put $N_2 = N_1\phi = aN_1b$; normality of N_2 follows from that of N_1 . We also have

$$S^1(N_2 \times N_2)S^1 = S^1(aN_1b \times aN_1b)S^1 = S^1(a(N_1 \times N_1)b)S^1 \subseteq S^1(N_1 \times N_1)S^1,$$

which gives $\nu_{N_2} = S^1(N_2 \times N_2)S^1 \cap (J \times J) \subseteq S^1(N_1 \times N_1)S^1 \cap (J \times J) = \nu_{N_1}$. Similarly, $\nu_{N_1} \subseteq \nu_{N_2}$. \square

In addition to the relations ν_N , defined above, we need one more key concept in order to describe the remaining families of congruences.

Definition 3.16. An *IN-pair* on a semigroup S is a pair $\mathcal{C} = (I, N)$, where I is an ideal of S , and N is a normal subgroup of a maximal subgroup of S contained in some stable, regular \mathcal{J} -class J that is minimal in the set $(S \setminus I)/\mathcal{J}$. To such an IN-pair, we associate the relation

$$R_{\mathcal{C}} = R_{I,N} = R_I \cup \nu_N = \Delta_S \cup \nu_N \cup (I \times I),$$

where ν_N is given in Definition 3.14. Clearly, when $|N| = 1$, $\nu_N = \Delta_J \subseteq \Delta_S$, and so $R_{I,N} = R_I$ is the Rees congruence associated to I (Definition 3.1); thus, we say an IN-pair $\mathcal{C} = (I, N)$ is *proper* if $|N| \geq 2$.

Our final family of congruences involve a special kind of IN-pair.

Definition 3.17. Let S be a semigroup with a minimal ideal. We say that an IN-pair $\mathcal{C} = (I, N)$ on S is *retractable* if I is a retractable ideal (Definition 3.2), and all the elements of N act the same way on M : i.e., $|xN| = |Nx| = 1$ for all $x \in M$. For such a retractable IN-pair, and for a lifting congruence ξ on M (Definition 3.6), we define the relation

$$\zeta_{I,N,\xi} = \zeta_{I,\xi} \cup \nu_N = \Delta_S \cup \nu_N \cup \{(x, y) \in I \times I : (xf, yf) \in \xi\},$$

where $f : I \rightarrow M$ is the unique retraction, and where $\zeta_{I,\xi}$ and ν_N are given in Definitions 3.7 and 3.14, respectively.

By Lemma 3.12, every retractable IN-pair on a semigroup with a stable minimal ideal yields a natural family of $\zeta_{I,N,\xi}$ relations:

Definition 3.18. Let S be a semigroup with a stable minimal ideal. To every retractable IN-pair $\mathcal{C} = (I, N)$ on S (Definition 3.17), we associate four relations:

$$\begin{aligned} \lambda_{\mathcal{C}} &= \lambda_{I,N} = \zeta_{I,N,\mathcal{L}^M} = \lambda_I \cup \nu_N = \Delta_S \cup \nu_N \cup \{(x, y) \in I \times I : xf \mathcal{L} yf\}, \\ \rho_{\mathcal{C}} &= \rho_{I,N} = \zeta_{I,N,\mathcal{R}^M} = \rho_I \cup \nu_N = \Delta_S \cup \nu_N \cup \{(x, y) \in I \times I : xf \mathcal{R} yf\}, \\ \mu_{\mathcal{C}} &= \mu_{I,N} = \zeta_{I,N,\mathcal{H}^M} = \mu_I \cup \nu_N = \Delta_S \cup \nu_N \cup \{(x, y) \in I \times I : xf \mathcal{H} yf\}, \\ \eta_{\mathcal{C}} &= \eta_{I,N} = \zeta_{I,N,\Delta_M} = \eta_I \cup \nu_N = \Delta_S \cup \nu_N \cup \{(x, y) \in I \times I : xf = yf\}, \end{aligned}$$

where $f : I \rightarrow M$ is the unique retraction.

Again, if $|N| = 1$, then the relations from Definitions 3.17 and 3.18 reduce to those from Definitions 3.7 and 3.13, respectively. In what follows, we will prove that the relations given in Definitions 3.16–3.18 are congruences, and discuss their inclusions, meets and joins.

Lemma 3.19. *Let S be a semigroup with a stable minimal ideal. If $\mathcal{C} = (I, N)$ is an IN-pair on S , and if $(x, y) \in \nu_N$ and $s \in S$, then $(xs, ys), (sx, sy) \in R_{\mathcal{C}}$. Furthermore, if \mathcal{C} is retractable, then $(xs, ys), (sx, sy) \in \eta_{\mathcal{C}}$.*

Proof. It suffices to prove the statements for (xs, ys) , as the proofs for (sx, sy) are dual. Denote by J the (stable, regular) \mathcal{J} -class containing N . Since $(x, y) \in \nu_N$, we may write $(x, y) = (puq, pvq)$ where $u, v \in N$ and $p, q \in S^1$. As in the proof of Lemma 3.10, since $u \mathcal{J} x = puq$, it follows that $u \mathcal{L} pu \mathcal{R} puq = x$. By Green's Lemma (see Lemmas 2.2.1–2.2.3 and their proofs, in [19]), it follows that the map

$$H_u \rightarrow H_x : z \mapsto p z q$$

is a bijection (recall that H_u and H_x denote the \mathcal{H} -classes of u and x , respectively). Consequently, since $v \in H_u$, we have $y = pvq \in H_x$. Since $x \mathcal{H} y$, it follows in particular that $x \mathcal{L} y$, and so $xs \mathcal{L} ys$. Thus, we either have $xs, ys \in J$ or else $xs, ys \notin J$. If $xs, ys \in J$, then

$$(xs, ys) = (pu(qs), pv(qs)) \in \nu_N \subseteq \eta_{\mathcal{C}} \subseteq R_{\mathcal{C}},$$

completing the proof in this case. For the remainder of the proof, we assume that $xs, ys \notin J$. By the minimality of J in $(S \setminus I)/\mathcal{J}$, it follows that $xs, ys \in I$ and so $(xs, ys) \in I \times I \subseteq R_{\mathcal{C}}$, which concludes the proof of the first statement.

Suppose from now on that \mathcal{C} is retractable. Denote by M the minimal ideal, and by $f : I \rightarrow M$ the retraction. Since $xs \mathcal{L} ys$, we may write $xs = ays$ and $ys = bxs$ for some $a, b \in S^1$. But then $(xs)f = (ays)f = a(ys)f$, by Lemma 3.3, and similarly $(ys)f = b(xs)f$, so that $(xs)f \mathcal{L} (ys)f$. Since M is regular (by Lemma 3.11), there exists an idempotent e in the \mathcal{L} -class of $(xs)f$, and we note that e is a right identity for both $(xs)f$ and $(ys)f$. Since $u, v \in N$ and $qse \in M$, and since every element of N has the same action on M , it follows that $uqse = vqse$. Hence, $(xs)f = (xs)fe = (xse)f = (puqse)f = (pvqse)f = (yse)f = (ys)fe = (ys)f$, and so $(xs, ys) \in \eta_{\mathcal{C}}$, completing the proof. \square

Remark 3.20. If S has a stable minimal ideal M (which is regular, by Lemma 3.11), and if N is a normal subgroup of any maximal subgroup G contained in M , then ν_N is in fact a lifting congruence, as follows from the proof of Lemma 3.19 with $J = M$ (the case in which $xs, ys \notin J$ does not arise). The induced congruence $\zeta_{M, \nu_N} = \Delta_S \cup \nu_N$ from Definition 3.7 satisfies $\eta_M = \Delta_S \subseteq \zeta_{M, \nu_N} \subseteq \zeta_{M, \nu_G} = \mu_M$, and the interval in $\text{Cong}(S)$ from Δ_S to μ_M is isomorphic to the lattice of normal subgroups of G . Since the minimal ideal is \mathcal{H} -trivial in all the diagram monoids we consider, such lifting congruences will play no part in this paper.

Remark 3.21. Stability of J was a crucial ingredient in the proof of Lemma 3.19. Indeed, consider the full transformation semigroup \mathcal{T}_X on an infinite set X . Let $X = Y \cup Z$, where $Y \cap Z = \emptyset$ and $|X| = |Y| = |Z|$. Let $J = \{f \in \mathcal{T}_X : \text{rank}(f) = |X|\}$, and let $N = \mathcal{S}_X$ be the symmetric group on X . So J is a non-stable, regular \mathcal{J} -class of \mathcal{T}_X , and N is a maximal subgroup of \mathcal{T}_X contained in J . We define transformations $u, v, p, q, s \in \mathcal{T}_X$ as follows. First, let $u = q = \text{id}_X$ be the identity map on X . Next, let v be any transformation that maps Y bijectively onto Z , and Z bijectively onto Y . Fix some element $w \in Y$, and let $p = s$ be the transformation that maps Y identically, and maps all of Z onto w . Then $u, v \in N$ and $(x, y) = (puq, pvq) \in \nu_N$. However, $xs = p \in J$ but ys is the constant map with image $\{w\}$, so that $ys \notin J$, whence (xs, ys) belongs neither to ν_N nor to $I \times I$, where I is the ideal $\mathcal{T}_X \setminus J$. Consequently, the relation $R_I \cup \nu_N$ is not a congruence on \mathcal{T}_X .

Proposition 3.22. *Let S be a semigroup with a stable minimal ideal. If \mathcal{C} is an IN-pair on S , then $R_{\mathcal{C}}$ is a congruence on S . Furthermore, if $\mathcal{C} = (I, N)$ is retractable, and ξ is a lifting congruence on the minimal ideal of S , then $\zeta_{I, N, \xi}$ is also a congruence on S . In particular, $\lambda_{\mathcal{C}}, \rho_{\mathcal{C}}, \mu_{\mathcal{C}}$ and $\eta_{\mathcal{C}}$ are all congruences if \mathcal{C} is retractable.*

Proof. From Lemma 3.19 and the fact that R_I is a congruence, it follows immediately that $R_{\mathcal{C}} = R_I \cup \nu_N$ is a congruence. Now suppose \mathcal{C} is retractable, and that ξ is a lifting congruence on the minimal ideal. Let $(x, y) \in \zeta_{I, N, \xi} = \zeta_{I, \xi} \cup \nu_N$ and $s \in S$. We must show that $(sx, sy), (xs, ys) \in \zeta_{I, N, \xi}$. This follows from Proposition 3.8 if $(x, y) \in \zeta_{I, \xi}$, or from Lemma 3.19 if $(x, y) \in \nu_N$, using the fact that $\eta_{\mathcal{C}} \subseteq \zeta_{I, N, \xi}$. \square

Remark 3.23. If N_1, \dots, N_k are normal subgroups of maximal subgroups of S contained in distinct stable, regular \mathcal{J} -classes that are each minimal in $S \setminus I$, then, by a similar argument to that used in the proof of Proposition 3.22, $R_I \cup \nu_{N_1} \cup \dots \cup \nu_{N_k}$ is a congruence; a similar comment may also be made concerning the case in which I is retractable. However, since the \mathcal{J} -classes form a chain in every diagram monoid we consider, this situation does not arise in our subsequent investigations.

We now elucidate the relationships between the congruences defined in this section within the lattice $\text{Cong}(S)$.

Proposition 3.24. *Let S be a semigroup with a stable minimal ideal. Suppose $\mathcal{C}_1 = (I_1, N_1)$ and $\mathcal{C}_2 = (I_2, N_2)$ are IN-pairs on S , and that J_1 and J_2 are the \mathcal{J} -classes of N_1 and N_2 , respectively. If $I_1 \cup J_1 \subseteq I_2$, or $I_1 = I_2$ and $N_1 \subseteq N_2$, then $R_{\mathcal{C}_1} \subseteq R_{\mathcal{C}_2}$.*

Proof. If $I_1 \cup J_1 \subseteq I_2$, then $R_{\mathcal{C}_1} = R_{I_1} \cup \nu_{N_1} \subseteq R_{I_2} \cup (J_1 \times J_1) \subseteq R_{I_2} \cup (I_2 \times I_2) = R_{I_2} \subseteq R_{\mathcal{C}_2}$. If $I_1 = I_2$ and $N_1 \subseteq N_2$, then $R_{\mathcal{C}_1} = R_{I_1} \cup \nu_{N_1} \subseteq R_{I_1} \cup \nu_{N_2} = R_{\mathcal{C}_2}$. \square

Proposition 3.25. *Let S be a semigroup with a stable minimal ideal. Suppose $\mathcal{C}_1 = (I_1, N_1)$ and $\mathcal{C}_2 = (I_2, N_2)$ are retractable IN-pairs on S , and that J_1 and J_2 are the \mathcal{J} -classes of N_1 and N_2 , respectively. If $I_1 \cup J_1 \subseteq I_2$, or $I_1 = I_2$ and $N_1 \subseteq N_2$, then*

- (i) $\lambda_{\mathcal{C}_1} \subseteq \lambda_{\mathcal{C}_2}$, $\rho_{\mathcal{C}_1} \subseteq \rho_{\mathcal{C}_2}$, $\mu_{\mathcal{C}_1} \subseteq \mu_{\mathcal{C}_2}$, $\eta_{\mathcal{C}_1} \subseteq \eta_{\mathcal{C}_2}$,
- (ii) $\lambda_{\mathcal{C}_1} \cap \rho_{\mathcal{C}_2} = \rho_{\mathcal{C}_1} \cap \lambda_{\mathcal{C}_2} = \mu_{\mathcal{C}_1}$,
- (iii) $\lambda_{\mathcal{C}_1} \vee \rho_{\mathcal{C}_2} = \rho_{\mathcal{C}_1} \vee \lambda_{\mathcal{C}_2} = R_{\mathcal{C}_2}$,
- (iv) $\lambda_{\mathcal{C}_1} \cap \mu_{\mathcal{C}_2} = \rho_{\mathcal{C}_1} \cap \mu_{\mathcal{C}_2} = \mu_{\mathcal{C}_1}$,
- (v) $\lambda_{\mathcal{C}_1} \vee \mu_{\mathcal{C}_2} = \lambda_{\mathcal{C}_2}$ and $\rho_{\mathcal{C}_1} \vee \mu_{\mathcal{C}_2} = \rho_{\mathcal{C}_2}$,
- (vi) $R_{\mathcal{C}_1} \cap \mu_{\mathcal{C}_2} = \mu_{\mathcal{C}_1}$ and $R_{\mathcal{C}_1} \vee \mu_{\mathcal{C}_2} = R_{\mathcal{C}_2}$.

Proof. Let $f : I_2 \rightarrow M$ be the unique retraction. Since $I_1 \subseteq I_2$, the retraction of I_1 is the restriction of f to I_1 . Part (i) follows from the definition of the congruences in a manner similar to the proof of Proposition 3.24. For the rest of the proof, we abbreviate $\xi_{\mathcal{C}_i}$ to ξ_i , for $i \in \{1, 2\}$ and $\xi \in \{R, \lambda, \rho, \mu\}$.

For (ii), it is sufficient to prove one of the two assertions: say, $\lambda_1 \cap \rho_2 = \mu_1$. Clearly, $\mu_1 \subseteq \lambda_1$ and $\mu_1 \subseteq \rho_1 \subseteq \rho_2$, whence $\mu_1 \subseteq \lambda_1 \cap \rho_2$. For the converse inclusion, let $(x, y) \in \lambda_1 \cap \rho_2$. Following the definition of λ_1 , if $x = y$ then clearly $(x, y) \in \mu_1$, while if $(x, y) \in \nu_1$, then $(x, y) \in \mu_1$ since $\nu_1 \subseteq \mu_1$. Finally, suppose $(x, y) \notin \Delta_S \cup \nu_1$, so that $x, y \in I_1 \subseteq I_2$ with $xf \mathcal{L} yf$. Since also $(x, y) \in \rho_2$, it follows that $(x, y) \notin \Delta_S \cup \nu_2$, so that $xf \mathcal{R} yf$, and hence $xf \mathcal{H} yf$: i.e., $(x, y) \in \mu_1$.

To prove (iii), it is sufficient to show that $\lambda_1 \vee \rho_2 = R_2$. Clearly, $\rho_2 \subseteq R_2$ and $\lambda_1 \subseteq \lambda_2 \subseteq R_2$, whence $\lambda_1 \vee \rho_2 \subseteq R_2$. For the converse inclusion, let $(x, y) \in R_2$ be arbitrary. Following the definition of R_2 , if $x = y$ then clearly $(x, y) \in \lambda_1 \vee \rho_2$, while if $(x, y) \in \nu_2$, then $(x, y) \in \rho_2 \subseteq \lambda_1 \vee \rho_2$. Finally, consider $x, y \in I_2$. Since $xf, yf \in M$, and since M is a \mathcal{D} -class (by Lemma 3.10), there exists $z \in M$ such that $xf \mathcal{L} z \mathcal{R} yf$. From $M \subseteq I_1 \subseteq I_2$ and $z = zf$, we have $(x, xf) \in \rho_2$, $(xf, z) \in \lambda_1$ and $(z, y) \in \rho_2$, implying $(x, y) \in \lambda_1 \vee \rho_2$.

The proof of (iv) is similar to that of (ii), so we omit it. For (v), it suffices to prove that $\rho_1 \vee \mu_2 = \rho_2$. The forwards inclusion is again straightforward. For the converse, let $(x, y) \in \rho_2$. Since $\Delta_S \cup \nu_{N_2} \subseteq \mu_2 \subseteq \rho_1 \vee \mu_2$, it suffices to assume that $x, y \in I_2$ and $xf \mathcal{R} yf$. If $I_1 = I_2$, then it follows that $(x, y) \in \rho_1 \subseteq \rho_1 \vee \mu_2$, so suppose instead that $I_1 \cup J_1 \subseteq I_2$. Then, again using $M \subseteq I_1 \subseteq I_2$, we have $(x, xf) \in \mu_2$, $(xf, yf) \in \rho_1$ and $(yf, y) \in \mu_2$, so that $(x, y) \in \rho_1 \vee \mu_2$.

The proof of (vi) is similar to (but easier than) the proofs of (ii) and (v), so we omit it. \square

Remark 3.26. Consider the case that $I_1 = I_2$ and $N_1 \subseteq N_2$, in the notation of Proposition 3.25. From the proof of part (v), it follows that $\lambda_{\mathcal{C}_2}$ and $\rho_{\mathcal{C}_2}$ decompose as *unions*, not just joins:

$$\lambda_{\mathcal{C}_2} = \lambda_{\mathcal{C}_1} \cup \mu_{\mathcal{C}_2} \quad \text{and} \quad \rho_{\mathcal{C}_2} = \rho_{\mathcal{C}_1} \cup \mu_{\mathcal{C}_2}.$$

It is also easy to see (under the above assumption on I_1, I_2, N_1, N_2) that $R_{\mathcal{C}_2} = R_{\mathcal{C}_1} \cup \lambda_{\mathcal{C}_2} = R_{\mathcal{C}_1} \cup \rho_{\mathcal{C}_2}$.

Specialising Proposition 3.25 to the case where $\mathcal{C}_1 = \mathcal{C}_2$ we obtain the following.

Proposition 3.27. *Let S be a semigroup with a stable minimal ideal M , and let \mathcal{C} be a retractable IN-pair on S . Then*

- (i) $\eta_{\mathcal{C}} \subseteq \mu_{\mathcal{C}} = \lambda_{\mathcal{C}} \cap \rho_{\mathcal{C}}$ and $R_{\mathcal{C}} = \lambda_{\mathcal{C}} \vee \rho_{\mathcal{C}}$,
- (ii) $\eta_{\mathcal{C}} = \mu_{\mathcal{C}}$ if and only if M is \mathcal{H} -trivial,
- (iii) if M has at least two \mathcal{R} -classes and at least two \mathcal{L} -classes, then the congruences $\lambda_{\mathcal{C}}$ and $\rho_{\mathcal{C}}$ are incomparable in $\text{Cong}(S)$.

Proof. Part (i) is a direct consequence of Proposition 3.25. Parts (ii) and (iii) follow from the fact that the restrictions of $\lambda_{\mathcal{C}}, \rho_{\mathcal{C}}, \mu_{\mathcal{C}}$ to M are equal to the restrictions of $\mathcal{L}, \mathcal{R}, \mathcal{H}$ to M , respectively. \square

Proposition 3.27 can be interpreted as saying that the congruences $R_{\mathcal{C}}, \lambda_{\mathcal{C}}, \rho_{\mathcal{C}}$, and $\mu_{\mathcal{C}}$ corresponding to a retractable IN-pair form a sublattice inside $\text{Cong}(S)$, as depicted in Figure 3 (left). This diamond structure forms the basic building block from which the non-chain parts of the specific congruence lattices considered in this paper are built; see Figures 4, 5, 7 and 9. Our next result describes how two such diamonds compare to each other inside $\text{Cong}(S)$; it follows from Propositions 3.24–3.27.

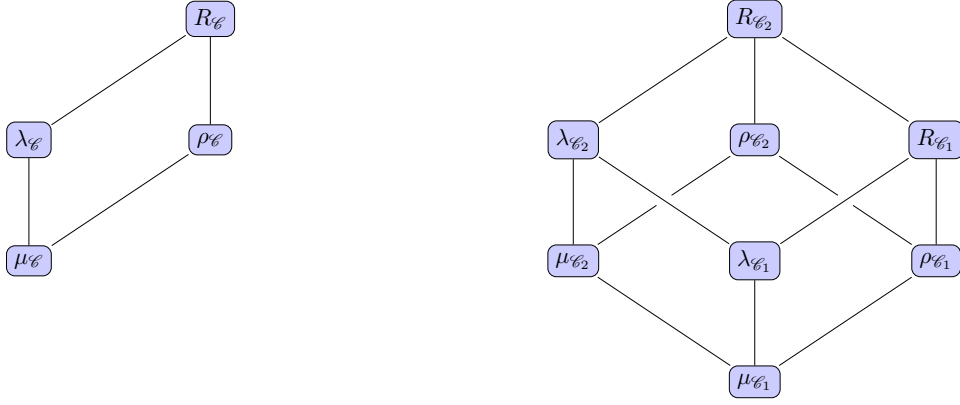

Figure 3: Left: the sublattice of $\text{Cong}(S)$ formed by the four congruences arising from a retractable IN-pair \mathcal{C} . Right: the sublattice of $\text{Cong}(S)$ consisting of the eight congruences arising from two retractable IN-pairs $\mathcal{C}_1, \mathcal{C}_2$ satisfying the conditions of Proposition 3.28.

Proposition 3.28. *Let S be a semigroup with a stable minimal ideal M . Suppose $\mathcal{C}_1 = (I_1, N_1)$ and $\mathcal{C}_2 = (I_2, N_2)$ are retractable IN-pairs on S , that J_1 and J_2 are the \mathcal{J} -classes of N_1 and N_2 , respectively, and that either $I_1 \cup J_1 \subseteq I_2$, or $I_1 = I_2$ and $N_1 \subseteq N_2$. If M has at least two \mathcal{R} -classes and at least two \mathcal{L} -classes, then the eight R, λ, ρ, μ congruences arising from \mathcal{C}_1 and \mathcal{C}_2 (see Definitions 3.16 and 3.18) form a sublattice of $\text{Cong}(S)$ whose Hasse diagram is depicted in Figure 3 (right). \square*

Finally, we record the following result, concerning the very least elements of the lattice; its proof is trivial, and omitted.

Proposition 3.29. *Let S be a semigroup with a stable minimal ideal M . Then the congruences from Definition 3.13 associated to M are*

$$\lambda_M = \Delta_S \cup \mathcal{L}^M, \quad \rho_M = \Delta_S \cup \mathcal{R}^M, \quad \mu_M = \Delta_S \cup \mathcal{H}^M, \quad \eta_M = \Delta_S.$$

In particular, if M is \mathcal{H} -trivial, then $\mu_M = \eta_M = \Delta_S$. \square

Remark 3.30. Let S be a semigroup with a stable minimal ideal M , and suppose I is a retractable ideal of S . By Definitions 3.1 and 3.13, the congruences $R_I, \lambda_I, \rho_I, \mu_I$ and η_I can be associated to I . As noted above, if $S \setminus I$ has a stable, regular, minimal \mathcal{J} -class, then these congruences coincide with the corresponding congruences from Definitions 3.16 and 3.18, for any trivial group N contained in any of these \mathcal{J} -classes. But this condition on \mathcal{J} -classes might fail to hold: namely, if $I = S$, or if all the minimal \mathcal{J} -classes in $S \setminus I$ are non-stable or non-regular. For such a semigroup S , one could prove results along the lines of Proposition 3.28 to describe the relationships between different collections of congruences. However, this does not arise in any of the applications we consider, as all of our diagram monoids are regular and finite (so stable) and their maximum retractable ideals are always proper if n is not trivially small, so we omit these details.

4 Congruence lattices of $\mathcal{S}_n, \mathcal{I}_n$ and \mathcal{O}_n

In this section we present the results of Liber [23] and Fernandes [14], describing the congruence lattices of the symmetric inverse monoid \mathcal{I}_n and the monoid \mathcal{O}_n of order-preserving partial permutations of \mathbf{n} . To prepare for our subsequent exposition, we present these results within the framework of the previous section.

First, however, let us recall the situation for the symmetric group \mathcal{S}_n , as this will also play a crucial role in many of our investigations. Congruences on any group G are uniquely determined by normal subgroups of G , and hence the congruence lattice of G is isomorphic to the lattice of normal subgroups of G . The normal subgroups of the symmetric group \mathcal{S}_n are easily described. They always form a chain:

- for $n = 1$: $\{\text{id}_1\} = \mathcal{S}_1$,
- for $n = 2$: $\{\text{id}_2\} \subsetneq \mathcal{S}_2$,
- for $n = 4$: $\{\text{id}_4\} \subsetneq K \subsetneq \mathcal{A}_4 \subsetneq \mathcal{S}_4$,
- for $n = 3$ or $n \geq 5$: $\{\text{id}_n\} \subsetneq \mathcal{A}_n \subsetneq \mathcal{S}_n$.

where \mathcal{A}_n denotes the *alternating group*, and $K = \{\text{id}_4, (1, 2)(3, 4), (1, 3)(2, 4), (1, 4)(2, 3)\}$ is the *Klein 4-group*.

We now turn to the symmetric inverse monoid \mathcal{I}_n . Recall that the \mathcal{J} -classes and ideals of \mathcal{I}_n are the sets

$$J_q = J_q(\mathcal{I}_n) = \{\alpha \in \mathcal{I}_n : \text{rank}(\alpha) = q\} \quad \text{and} \quad I_q = I_q(\mathcal{I}_n) = \{\alpha \in \mathcal{I}_n : \text{rank}(\alpha) \leq q\},$$

respectively, for $q = 0, \dots, n$. For each ideal I_q , we have the Rees congruence R_{I_q} (Definition 3.1), which we will denote by R_q for simplicity. The remaining congruences on \mathcal{I}_n may all be described in terms of IN-pairs (Definition 3.16). Recall from Lemma 3.15 that to describe all such pairs, it suffices to identify a single distinguished maximal subgroup from each \mathcal{J} -class (all \mathcal{J} -classes of \mathcal{I}_n are regular and stable). With this in mind, for $q = 0, \dots, n$, we define a mapping

$$\mathcal{S}_q \mapsto \mathcal{I}_n : \sigma \mapsto \bar{\sigma} = \begin{bmatrix} 1 & \cdots & q \\ 1\sigma & \cdots & q\sigma \end{bmatrix},$$

using the notation of Subsection 2.2. It is then easy to see that $\bar{\mathcal{S}}_q = \{\bar{\sigma} : \sigma \in \mathcal{S}_q\}$ is a maximal subgroup of \mathcal{I}_n contained in J_q . Furthermore, for $q = 1, \dots, n$ and for any normal subgroup N of \mathcal{S}_q , the pair (I_{q-1}, \bar{N}) is an IN-pair, and so yields a congruence $R_{I_{q-1}, \bar{N}}$, as given in Definition 3.16; again, for simplicity, we will abbreviate $R_{I_{q-1}, \bar{N}}$ to R_N . Since the minimal ideal $I_0 = J_0$ of \mathcal{I}_n has only one element, all ideals are trivially retractable, but no λ, ρ, μ congruences arise from any of these IN-pairs.

Theorem 4.1 (Liber [23]; see also [16, Section 6.3]). *Let $n \geq 0$, and let \mathcal{I}_n be the symmetric inverse monoid of degree n .*

- (i) *The ideals of \mathcal{I}_n are the sets I_q , for $q = 0, \dots, n$, yielding the Rees congruences $R_q = R_{I_q}$, as in Definition 3.1.*
- (ii) *The proper IN-pairs of \mathcal{I}_n are of the form (I_{q-1}, \bar{N}) , for $q = 2, \dots, n$ and for any non-trivial normal subgroup N of \mathcal{S}_q , yielding the congruences $R_N = R_{I_{q-1}, \bar{N}}$, as in Definition 3.16.*
- (iii) *The above congruences are distinct, and they exhaust all the congruences of \mathcal{I}_n .*
- (iv) *The congruence lattice $\text{Cong}(\mathcal{I}_n)$ forms the following chain:*

$$\Delta = R_0 \subsetneq R_1 \subsetneq R_{\mathcal{S}_2} \subsetneq R_2 \subsetneq R_{\mathcal{A}_3} \subsetneq R_{\mathcal{S}_3} \subsetneq R_3 \subsetneq R_K \subsetneq R_{\mathcal{A}_4} \subsetneq R_{\mathcal{S}_4} \subsetneq \cdots \subsetneq R_{\mathcal{S}_n} \subsetneq R_n = \nabla. \quad \square$$

For the monoid \mathcal{O}_n , the situation is even simpler. Here, we just have the Rees congruences R_{I_q} , abbreviated to R_q , associated to the ideal $I_q = I_q(\mathcal{O}_n) = \{\alpha \in \mathcal{O}_n : \text{rank}(\alpha) \leq q\}$.

Theorem 4.2 (Fernandes [14]). *Let $n \geq 0$, and let \mathcal{O}_n be the monoid of order-preserving partial permutations of the set $\mathbf{n} = \{1, \dots, n\}$.*

- (i) *The ideals of \mathcal{O}_n are the sets I_q , for $q = 0, \dots, n$, yielding the Rees congruences $R_q = R_{I_q}$, as in Definition 3.1.*
- (ii) *The above congruences are distinct, and they exhaust all the congruences of \mathcal{O}_n .*
- (iii) *The congruence lattice $\text{Cong}(\mathcal{O}_n)$ forms the following chain:*

$$\Delta = R_0 \subsetneq R_1 \subsetneq R_2 \subsetneq \cdots \subsetneq R_n = \nabla. \quad \square$$

Remark 4.3. From the fact that $\text{Cong}(\mathcal{I}_n)$ and $\text{Cong}(\mathcal{O}_n)$ are chains, it follows that all congruences on \mathcal{I}_n and \mathcal{O}_n are principal. Furthermore, a non-trivial congruence ξ on \mathcal{I}_n or \mathcal{O}_n is generated by any pair (α, β) from the set $\xi \setminus \xi^-$, where ξ^- is the maximal congruence properly contained in ξ . In actual fact, proving this is a major component in the proofs of Theorems 4.1 and 4.2.

5 The partition monoid \mathcal{P}_n

In this section, we show how the theory developed in Section 3 can be applied to describe all the congruences of the partition monoid \mathcal{P}_n . It will serve as a blue-print for all the subsequent sections. Since \mathcal{P}_1 has size 2, its congruence lattice is easily described, so we assume that $n \geq 2$ for the remainder of this section.

The basic strategy is to start with the chain of ideals of \mathcal{P}_n , identify the IN-pairs associated with these ideals, and determine which of them are retractable. Propositions 3.24–3.29 then enable us to calculate the lattice formed by the congruences arising from these ideals and IN-pairs. Finally, and this will be the brunt of the work in this section, we have to prove that there are no further congruences on \mathcal{P}_n .

From Proposition 2.1 we know that the \mathcal{J} -classes of \mathcal{P}_n are the sets $J_q = \{\alpha \in \mathcal{P}_n : \text{rank}(\alpha) = q\}$, for $q = 0, \dots, n$. The corresponding ideals are $I_q = J_0 \cup \dots \cup J_q$, giving rise to the Rees congruences R_{I_q} (Definition 3.1), which again will be denoted by R_q . The minimal ideal is $I_0 = J_0$, and it is a rectangular band.

For each proper ideal I_{q-1} ($q = 1, \dots, n$) there is a unique minimal \mathcal{J} -class contained in $\mathcal{P}_n \setminus I_{q-1}$: namely, J_q . All maximal subgroups contained in J_q are isomorphic to \mathcal{S}_q , the symmetric group of rank q . If for $\sigma \in \mathcal{S}_q$ we let $\bar{\sigma} = \begin{bmatrix} 1 & \dots & q \\ 1\sigma & \dots & q\sigma \end{bmatrix}$, as in Section 4, the mapping $\sigma \mapsto \bar{\sigma}$ is an isomorphism between \mathcal{S}_q and the maximal subgroup $\bar{\mathcal{S}}_q = \{\bar{\sigma} : \sigma \in \mathcal{S}_q\}$ contained in J_q .

For $q = 1, \dots, n$ and for every normal subgroup N of \mathcal{S}_q , the pair (I_{q-1}, \bar{N}) is an IN-pair. Such a pair yields the congruence $R_{I_{q-1}, \bar{N}}$, as in Definition 3.16, which throughout this section we will denote simply by R_N ; so

$$R_N = R_{I_{q-1}, \bar{N}} = R_{q-1} \cup \nu_N = \Delta \cup \nu_N \cup (I_{q-1} \times I_{q-1}),$$

where $\Delta = \Delta_{\mathcal{P}_n}$ and

$$\nu_N = \nu_{\bar{N}} = \{(\alpha\bar{\sigma}\beta, \alpha\bar{\tau}\beta) \in J_q \times J_q : \sigma, \tau \in N, \alpha, \beta \in \mathcal{P}_n\},$$

as in Definition 3.14. When $N = \{\text{id}_q\}$ is trivial, we obtain the Rees congruence R_{q-1} ; the *proper* IN-pairs occur when $|N| \geq 2$.

The above families of congruences, R_q and R_N , closely parallel the situation in $\text{Cong}(\mathcal{I}_n)$ as described in Section 4 (and also that in $\text{Cong}(\mathcal{T}_n)$ originally discovered by Mal'cev). In particular, they form a chain, by Proposition 3.24. However, \mathcal{P}_n also has some λ, ρ, μ congruences, arising from a retraction that we now describe.

Definition 5.1. For $\alpha \in \mathcal{P}_n$, let $\hat{\alpha}$ be the unique partition of rank 0 with the same kernel and cokernel as α .

Lemma 5.2. *The map $f : I_1 \rightarrow I_0 : \alpha \mapsto \hat{\alpha}$ is a retraction.*

Proof. Clearly f acts identically on I_0 . It remains to prove that $\hat{\alpha}\hat{\beta} = \widehat{\alpha\beta}$ for all $\alpha, \beta \in I_1 = J_0 \cup J_1$. This is clearly the case if $\alpha, \beta \in J_0$, so suppose without loss of generality that $\alpha \in J_1$ and $\beta \in I_1$. We may write $\alpha = \begin{pmatrix} A_0 & A_1 & \dots & A_r \\ B_0 & B_1 & \dots & B_s \end{pmatrix}$ and $\beta = \begin{pmatrix} C_0 & C_1 & \dots & C_t \\ D_0 & D_1 & \dots & D_u \end{pmatrix}$ or $\begin{pmatrix} C_0 & C_1 & \dots & C_t \\ D_0 & D_1 & \dots & D_u \end{pmatrix}$. Then $\hat{\alpha} = \begin{pmatrix} A_0 & A_1 & \dots & A_r \\ B_0 & B_1 & \dots & B_s \end{pmatrix}$ and $\hat{\beta} = \begin{pmatrix} C_0 & C_1 & \dots & C_t \\ D_0 & D_1 & \dots & D_u \end{pmatrix}$, while $\alpha\beta$ is equal to either $\begin{pmatrix} A_0 & A_1 & \dots & A_r \\ D_0 & D_1 & \dots & D_u \end{pmatrix}$ or $\begin{pmatrix} A_0 & A_1 & \dots & A_r \\ D_0 & D_1 & \dots & D_u \end{pmatrix}$. The identity $\hat{\alpha}\hat{\beta} = \widehat{\alpha\beta}$ quickly follows. \square

The ideal I_1 is in fact the *largest* retractable ideal of \mathcal{P}_n . It is not hard to prove this directly, but it also follows from Theorem 5.4. Indeed, if any larger ideal was retractable, then such an ideal would lead to additional λ, ρ, μ congruences, as in Definition 3.13.

All IN-pairs associated to the retractable ideals I_0, I_1 of \mathcal{P}_n are retractable, as we now show.

Lemma 5.3. *The IN-pairs $\mathcal{C}_0 = (I_0, \{\text{id}_1\})$, $\mathcal{C}_1 = (I_1, \{\text{id}_2\})$ and $\mathcal{C}_{\mathcal{S}_2} = (I_1, \bar{\mathcal{S}}_2)$ are all retractable.*

Proof. By Lemma 5.2, the stated ideals are all retractable, so it remains to prove that for every $\alpha \in I_0$, we have $|\alpha\bar{\mathcal{S}}_2| = 1 = |\bar{\mathcal{S}}_2\alpha|$. In fact, it suffices to prove the first equality, the second being dual. Recall that $\bar{\mathcal{S}}_2 = \{\beta, \gamma\}$, where $\beta = \begin{bmatrix} 1 & 2 \\ 1 & 2 \end{bmatrix}$ and $\gamma = \begin{bmatrix} 1 & 2 \\ 2 & 1 \end{bmatrix}$. Suppose $\alpha = \begin{pmatrix} A_1 & A_2 & \dots & A_r \\ B_1 & B_2 & \dots & B_s \end{pmatrix}$. If $(1, 2) \in \text{coker}(\alpha)$, then $\alpha\beta = \begin{pmatrix} A_1 & A_2 & \dots & A_r \\ 1, 2 & 3 & \dots & n \end{pmatrix} = \alpha\gamma$; otherwise, $\alpha\beta = \begin{pmatrix} A_1 & A_2 & \dots & A_r \\ 1 & 2 & \dots & n \end{pmatrix} = \alpha\gamma$. \square

To each of these three pairs, we can associate the λ, ρ, μ congruences given in Definition 3.18 (but note that the η and μ congruences are equal in each case, since $I_0 = J_0$ is \mathcal{H} -trivial). To simplify the notation, we will abbreviate these to $\lambda_0 = \lambda_{\mathcal{C}_0}$, $\lambda_1 = \lambda_{\mathcal{C}_1}$, $\lambda_{\mathcal{S}_2} = \lambda_{\mathcal{C}_{\mathcal{S}_2}}$, with similar notation also for the ρ and μ congruences. We can now state the main result of this section.

Theorem 5.4. Let $n \geq 2$, and let \mathcal{P}_n be the partition monoid of degree n .

- (i) The ideals of \mathcal{P}_n are the sets I_q , for $q = 0, \dots, n$, yielding the Rees congruences $R_q = R_{I_q}$, as in Definition 3.1.
- (ii) The proper IN-pairs of \mathcal{P}_n are of the form (I_{q-1}, \overline{N}) , for $q = 2, \dots, n$ and for any non-trivial normal subgroup N of \mathcal{S}_q , yielding the congruences $R_N = R_{I_{q-1}, \overline{N}}$, as in Definition 3.16.
- (iii) The retractable IN-pairs of \mathcal{P}_n are $\mathcal{C}_0 = (I_0, \{\overline{\text{id}}_1\})$, $\mathcal{C}_1 = (I_1, \{\overline{\text{id}}_2\})$ and $\mathcal{C}_{\mathcal{S}_2} = (I_1, \overline{\mathcal{S}}_2)$, yielding the congruences $\lambda_0, \rho_0, \mu_0, \lambda_1, \rho_1, \mu_1, \lambda_{\mathcal{S}_2}, \rho_{\mathcal{S}_2}, \mu_{\mathcal{S}_2}$, respectively, as in Definition 3.18.
- (iv) The above congruences are distinct, and they exhaust all the congruences of \mathcal{P}_n .
- (v) The Hasse diagram of the congruence lattice $\text{Cong}(\mathcal{P}_n)$ is shown in Figure 4.

Proof. That all the listed relations are congruences follows from Proposition 3.22, and that they form the lattice depicted in Figure 4 follows from Propositions 3.24–3.29. What therefore remains to be proved is that they exhaust all the congruences of \mathcal{P}_n . Since every congruence is a join of principal congruences, this can be accomplished by showing that our list contains all the principal congruences. The principal congruences are shaded blue in Figure 4, and below we will for each of them describe all generating pairs. The proof is then completed by observing that this covers all possible pairs, as summarised in Table 1. \square

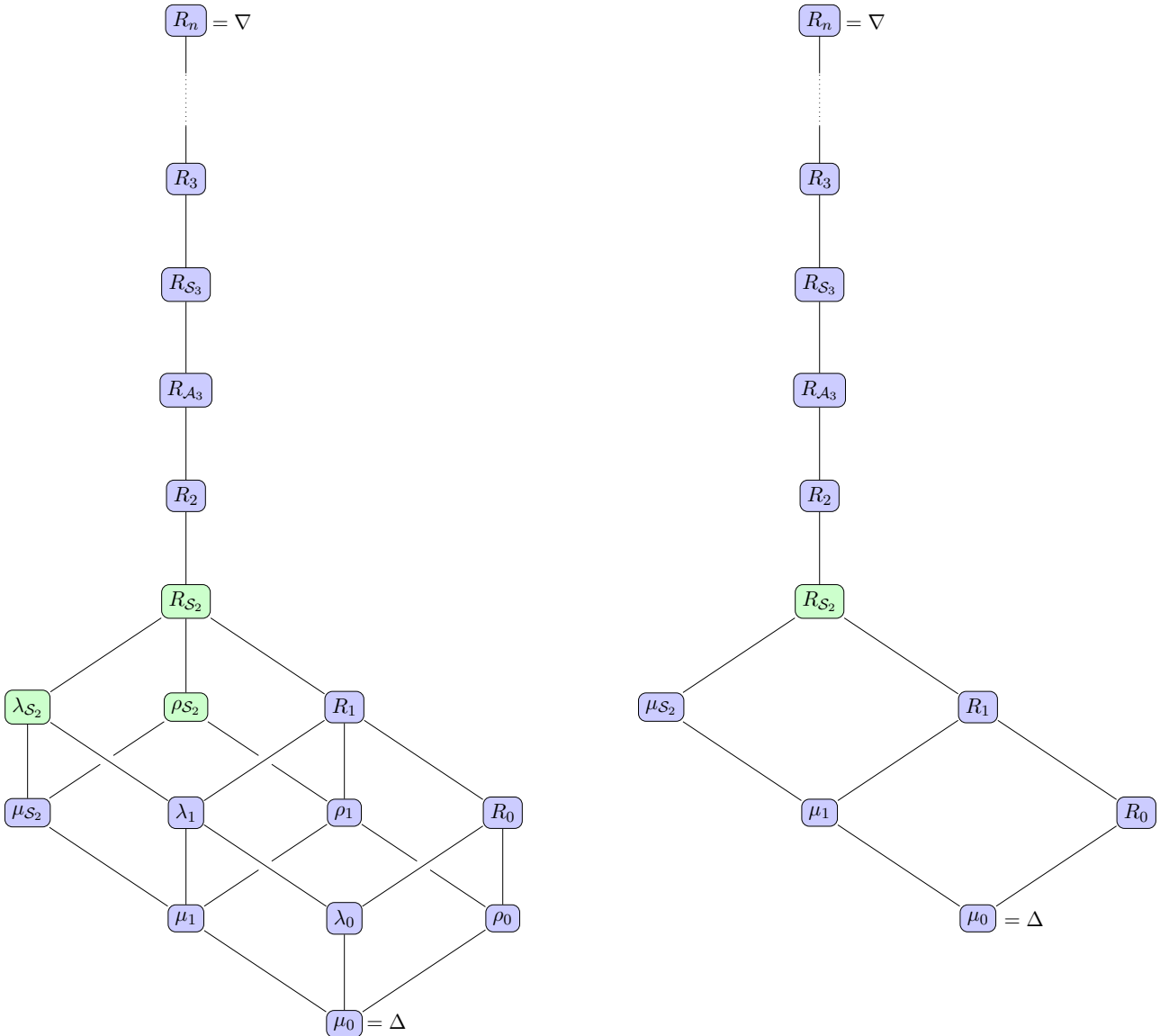

Figure 4: Hasse diagrams for the congruence lattice (left) and the $*$ -congruence lattice (right) of the partition monoid \mathcal{P}_n . Congruences shaded blue are principal; those shaded green are minimally generated by two pairs of partitions. The diagrams also serve for the partial Brauer monoid \mathcal{PB}_n (see Section 6).

q	Additional conditions	$(\alpha, \beta)^\#$	Reference
	$\alpha = \beta$	Δ	
0	$(\alpha, \beta) \in \mathcal{R} \setminus \Delta$	ρ_0	Proposition 5.8(i)
0	$(\alpha, \beta) \in \mathcal{L} \setminus \Delta$	λ_0	Proposition 5.8(ii)
0	$(\alpha, \beta) \notin \mathcal{L} \cup \mathcal{R}$	R_0	Proposition 5.9(i)
1	$\widehat{\alpha} = \widehat{\beta}, \alpha \neq \beta$	μ_1	Proposition 5.8(iii)
1	$(\widehat{\alpha}, \widehat{\beta}) \in \mathcal{R} \setminus \Delta$	ρ_1	Proposition 5.9(ii)
1	$(\widehat{\alpha}, \widehat{\beta}) \in \mathcal{L} \setminus \Delta$	λ_1	Proposition 5.9(iii)
1	$(\widehat{\alpha}, \widehat{\beta}) \notin \mathcal{L} \cup \mathcal{R}$	R_1	Proposition 5.9(iv)
2	$(\alpha, \beta) \in \mathcal{H} \setminus \Delta$	$\mu_{\mathcal{S}_2}$	Proposition 5.8(iv)
≥ 2	$(\alpha, \beta) \notin \mathcal{H}$	R_q	Proposition 5.16
≥ 3	$(\alpha, \beta) \in \mathcal{H} \setminus \Delta$	R_N	Proposition 5.16

Table 1: The principal congruences $(\alpha, \beta)^\#$ on \mathcal{P}_n , with $q = \text{rank}(\alpha) \geq \text{rank}(\beta)$. In the last row, N stands for the normal closure in \mathcal{S}_q of $\phi(\alpha, \beta)$.

As noted in the above proof, the rest of this section is devoted to describing the generating pairs for the principal congruences on \mathcal{P}_n . Throughout, we will refer to the congruences forming the ‘‘prism shaped’’ part of the congruence lattice (i.e., $R_{\mathcal{S}_2}$ and all the congruences contained in it) as the *lower congruences*, and those forming the ‘‘wick’’ (i.e., congruences containing $R_{\mathcal{S}_2}$) as the *upper congruences*.

Before we move on, it will be convenient to give an alternative description of the relations ν_N on \mathcal{P}_n from Definition 3.14. To do so, we first make the following definition.

Definition 5.5. Let $\alpha, \beta \in J_q$ with $\alpha \mathcal{H} \beta$ and $q \geq 1$, and suppose the kernel-classes of α , and hence also of β , are $A_1, \dots, A_q, C_1, \dots, C_r$, where $\text{dom}(\alpha) = \text{dom}(\beta) = A_1 \cup \dots \cup A_q$ and $\min(A_1) < \dots < \min(A_q)$. Then $\alpha\beta^* = \left(\begin{array}{c|ccc} A_1 & \dots & A_q & \begin{array}{c|ccc} C_1 & \dots & C_r \end{array} \\ \hline A_{1\sigma} & \dots & A_{q\sigma} & \begin{array}{c|ccc} C_1 & \dots & C_r \end{array} \end{array} \right)$ for some permutation $\sigma \in \mathcal{S}_q$, and we define $\phi(\alpha, \beta) = \sigma$.

We now establish the connection between the relations ν_N and the permutations $\phi(\alpha, \beta)$ from Definitions 3.14 and 5.5. In what follows, we will generally use the next result without explicit reference.

Lemma 5.6. *If $q \geq 1$, and if N is a normal subgroup of \mathcal{S}_q , then*

$$\nu_N = \{(\alpha, \beta) \in J_q \times J_q : \alpha \mathcal{H} \beta, \phi(\alpha, \beta) \in N\}.$$

Proof. Let $\Omega = \{(\alpha, \beta) \in J_q \times J_q : \alpha \mathcal{H} \beta, \phi(\alpha, \beta) \in N\}$ be the set in the statement of the lemma. First suppose $(\alpha, \beta) \in \Omega$, and write $\alpha = \left(\begin{array}{c|ccc} A_1 & \dots & A_q & \begin{array}{c|ccc} C_1 & \dots & C_r \end{array} \\ \hline B_1 & \dots & B_q & \begin{array}{c|ccc} D_1 & \dots & D_s \end{array} \end{array} \right)$ where $\min(A_1) < \dots < \min(A_q)$. Since $\alpha \mathcal{H} \beta$, we have $\beta = \left(\begin{array}{c|ccc} A_1 & \dots & A_q & \begin{array}{c|ccc} C_1 & \dots & C_r \end{array} \\ \hline B_{1\sigma} & \dots & B_{q\sigma} & \begin{array}{c|ccc} D_1 & \dots & D_s \end{array} \end{array} \right)$ for some $\sigma \in \mathcal{S}_q$, and it is clear that $\sigma = \phi(\alpha, \beta)^{-1} \in N$. But then $(\alpha, \beta) = (\gamma \overline{\text{id}}_q \delta, \gamma \overline{\sigma} \delta)$, where $\gamma = \left(\begin{array}{c|ccc} A_1 & \dots & A_q & \begin{array}{c|ccc} C_1 & \dots & C_r \end{array} \\ \hline 1 & \dots & q & \begin{array}{c|ccc} q+1 & \dots & n \end{array} \end{array} \right)$ and $\delta = \left(\begin{array}{c|ccc} 1 & \dots & q & \begin{array}{c|ccc} q+1 & \dots & n \end{array} \\ \hline B_1 & \dots & B_q & \begin{array}{c|ccc} D_1 & \dots & D_s \end{array} \end{array} \right)$, giving $(\alpha, \beta) \in \nu_N$.

Conversely, suppose $(\alpha, \beta) \in \nu_N$, so that $(\alpha, \beta) = (\gamma \overline{\sigma} \delta, \gamma \overline{\tau} \delta) \in J_q \times J_q$ for some $\gamma, \delta \in \mathcal{P}_n$ and $\sigma, \tau \in N$. Since $(\alpha, \beta) = (\gamma \cdot \overline{\text{id}}_q \cdot \overline{\sigma} \delta, \gamma \cdot \overline{\tau} \overline{\sigma}^* \cdot \overline{\sigma} \delta)$, with $\overline{\tau} \overline{\sigma}^* \in \overline{N}$, it suffices to assume that $\sigma = \text{id}_q$. So $(\alpha, \beta) = (\gamma \overline{\text{id}}_q \delta, \gamma \overline{\tau} \delta)$. Since $\alpha \in J_q$, we may write $\alpha = \left(\begin{array}{c|ccc} A_1 & \dots & A_q & \begin{array}{c|ccc} C_1 & \dots & C_r \end{array} \\ \hline B_1 & \dots & B_q & \begin{array}{c|ccc} D_1 & \dots & D_s \end{array} \end{array} \right)$. As noted in the proof of Proposition 3.22, $\alpha \mathcal{H} \beta$, so we may write $\beta = \left(\begin{array}{c|ccc} A_1 & \dots & A_q & \begin{array}{c|ccc} C_1 & \dots & C_r \end{array} \\ \hline B_{1\theta} & \dots & B_{q\theta} & \begin{array}{c|ccc} D_1 & \dots & D_s \end{array} \end{array} \right)$ for some $\theta \in \mathcal{S}_q$. For each $1 \leq i \leq q$, choose some $a_i \in A_i$ and $b_i \in B_i$. Since $\overline{\text{id}}_q$ and $\alpha = \gamma \overline{\text{id}}_q \delta$ both belong to J_q , it follows that $\gamma \overline{\text{id}}_q$ and $\overline{\text{id}}_q \delta$ do as well. Thus, renaming the sets A_i if necessary, we may assume that there is a path π_i in the product graph $\Pi(\gamma, \overline{\text{id}}_q)$ from a_i to i'' , and a path π'_i in $\Pi(\overline{\text{id}}_q, \delta)$ from i'' to b'_i . Since $\ker(\overline{\text{id}}_q) = \text{coker}(\overline{\text{id}}_q)$ is trivial, these paths involve only edges from γ or from δ , respectively. In particular, the paths π_i and π'_i are also in the product graphs $\Pi(\gamma, \overline{\tau})$ and $\Pi(\overline{\tau}, \delta)$, respectively, for each i . It then follows that a_i and $b'_{i\tau}$ belong to the same block of $\beta = \gamma \overline{\tau} \delta$: i.e., that $\theta = \tau$. Now let $\omega \in \mathcal{S}_q$ be such that $\min(A_{1\omega}) < \dots < \min(A_{q\omega})$, and put $E_i = A_{i\omega}$ for each i . Then

$$\alpha = \left(\begin{array}{c|ccc} E_1 & \dots & E_q & \begin{array}{c|ccc} C_1 & \dots & C_r \end{array} \\ \hline B_{1\omega} & \dots & B_{q\omega} & \begin{array}{c|ccc} D_1 & \dots & D_s \end{array} \end{array} \right), \quad \beta = \left(\begin{array}{c|ccc} E_1 & \dots & E_q & \begin{array}{c|ccc} C_1 & \dots & C_r \end{array} \\ \hline B_{1\omega\tau} & \dots & B_{q\omega\tau} & \begin{array}{c|ccc} D_1 & \dots & D_s \end{array} \end{array} \right), \quad \alpha\beta^* = \left(\begin{array}{c|ccc} E_1 & \dots & E_q & \begin{array}{c|ccc} C_1 & \dots & C_r \end{array} \\ \hline E_{1\omega\tau^{-1}\omega^{-1}} & \dots & E_{q\omega\tau^{-1}\omega^{-1}} & \begin{array}{c|ccc} C_1 & \dots & C_r \end{array} \end{array} \right),$$

so that $\phi(\alpha, \beta) = \omega\tau^{-1}\omega^{-1} \in N$. \square

For ease of reference in the proofs that follow, it will be convenient to list the explicit criteria for membership in each of the lower congruences (these follow from Definitions 3.16, 3.18, 5.1, Proposition 2.1 and Lemma 5.6):

- $\rho_0 = \Delta \cup \{(\alpha, \beta) \in I_0 \times I_0 : \ker(\alpha) = \ker(\beta)\}$,
- $\lambda_0 = \Delta \cup \{(\alpha, \beta) \in I_0 \times I_0 : \text{coker}(\alpha) = \text{coker}(\beta)\}$,
- $\rho_1 = \Delta \cup \{(\alpha, \beta) \in I_1 \times I_1 : \ker(\alpha) = \ker(\beta)\}$,
- $\lambda_1 = \Delta \cup \{(\alpha, \beta) \in I_1 \times I_1 : \text{coker}(\alpha) = \text{coker}(\beta)\}$,
- $\rho_{\mathcal{S}_2} = \rho_1 \cup (\mathcal{H} \cap (J_2 \times J_2))$,
- $\lambda_{\mathcal{S}_2} = \lambda_1 \cup (\mathcal{H} \cap (J_2 \times J_2))$,
- $\mu_1 = \Delta \cup \{(\alpha, \beta) \in I_1 \times I_1 : \widehat{\alpha} = \widehat{\beta}\}$,
- $\mu_{\mathcal{S}_2} = \mu_1 \cup (\mathcal{H} \cap (J_2 \times J_2))$.

We will repeatedly refer to Liber’s classification of congruences on the symmetric inverse monoid \mathcal{I}_n as presented in Theorem 4.1. Whenever there is notational conflict between congruences on \mathcal{P}_n and on \mathcal{I}_n , we will resolve it by placing bars above the latter. Thus, for example, for a normal subgroup N of \mathcal{S}_q , we will write R_N for the congruence it gives rise to on \mathcal{P}_n , and $\overline{R}_N = R_N \cap (\mathcal{I}_n \times \mathcal{I}_n)$ for its \mathcal{I}_n analogue.

Lemma 5.7. *Let $\xi \in \text{Cong}(\mathcal{P}_n)$.*

- (i) *If $\overline{R}_1 \subseteq \xi$, then $\mu_1 \subseteq \xi$. Thus, $\mu_1 = \overline{R}_1^\sharp$.* (ii) *If $\overline{R}_{\mathcal{S}_2} \subseteq \xi$, then $\mu_{\mathcal{S}_2} \subseteq \xi$. Thus, $\mu_{\mathcal{S}_2} = \overline{R}_{\mathcal{S}_2}^\sharp$.*

Proof. To prove (i), suppose $\overline{R}_1 \subseteq \xi$. Let $\alpha \in \mathcal{P}_n$ with $\text{rank}(\alpha) \leq 1$. Consulting the above membership criterion for μ_1 , it suffices to show that $(\alpha, \widehat{\alpha}) \in \xi$. This is clearly the case if $\text{rank}(\alpha) = 0$, so suppose $\text{rank}(\alpha) = 1$. Write $\alpha = \left(\begin{array}{c|c|c|c} A_0 & A_1 & \cdots & A_r \\ \hline B_0 & B_1 & \cdots & B_s \end{array} \right)$, so that $\widehat{\alpha} = \left(\begin{array}{c|c|c|c} A_0 & A_1 & \cdots & A_r \\ \hline B_0 & B_1 & \cdots & B_s \end{array} \right)$, and define $\gamma = \left(\begin{array}{c|c|c|c} A_0 & A_1 & \cdots & A_r \\ \hline 1 & 2 & \cdots & n \end{array} \right)$ and $\delta = \left(\begin{array}{c|c|c|c} 1 & 2 & \cdots & n \\ \hline B_0 & B_1 & \cdots & B_s \end{array} \right)$. Also define elements $\sigma, \tau \in \mathcal{I}_n \subseteq \mathcal{P}_n$ by $\sigma = \left[\begin{array}{c} 1 \\ 1 \end{array} \right]$ and $\tau = [\emptyset]$, noting that $(\sigma, \tau) \in \overline{R}_1 \subseteq \xi$. It then follows that $\alpha = \gamma\sigma\delta \xi \gamma\tau\delta = \widehat{\alpha}$, completing the proof of the first assertion. To prove the second assertion, since certainly $\overline{R}_1 \subseteq \overline{R}_1^\sharp$, it follows from the first assertion that $\mu_1 \subseteq \overline{R}_1^\sharp$. But it is also clear that $\overline{R}_1 \subseteq \mu_1$, so since μ_1 is a congruence, it follows that $\overline{R}_1^\sharp \subseteq \mu_1$.

To prove (ii), suppose $\overline{R}_{\mathcal{S}_2} \subseteq \xi$. Note that $\mu_{\mathcal{S}_2} = \mu_1 \cup (\nu_{\mathcal{S}_2} \setminus \Delta)$. Since $\overline{R}_1 \subseteq \overline{R}_{\mathcal{S}_2} \subseteq \xi$, part (i) gives $\mu_1 \subseteq \xi$. Now let $(\alpha, \beta) \in \nu_{\mathcal{S}_2} \setminus \Delta$. Since $\text{rank}(\alpha) = \text{rank}(\beta) = 2$ and $\alpha \not\sim \beta$, we may write $\alpha = \left(\begin{array}{c|c|c|c} A_1 & A_2 & C_1 & \cdots & C_r \\ \hline B_1 & B_2 & D_1 & \cdots & D_s \end{array} \right)$ and $\beta = \left(\begin{array}{c|c|c|c} A_1 & A_2 & C_1 & \cdots & C_r \\ \hline B_2 & B_1 & D_1 & \cdots & D_s \end{array} \right)$. Define $\gamma = \left(\begin{array}{c|c|c|c} A_1 & A_2 & C_1 & \cdots & C_r \\ \hline 1 & 2 & 3 & \cdots & n \end{array} \right)$ and $\delta = \left(\begin{array}{c|c|c|c} 1 & 2 & 3 & \cdots & n \\ \hline B_1 & B_2 & D_1 & \cdots & D_s \end{array} \right)$. Also put $\sigma = \left[\begin{array}{c} 1 & 2 \\ 1 & 2 \end{array} \right]$ and $\tau = \left[\begin{array}{c} 1 & 2 \\ 2 & 1 \end{array} \right]$, noting that $(\sigma, \tau) \in \overline{R}_{\mathcal{S}_2} \subseteq \xi$. It then follows that $\alpha = \gamma\sigma\delta \xi \gamma\tau\delta = \beta$. The second assertion of (ii) is proved in a similar way to the second assertion of (i). \square

We can now describe the generating pairs for the congruences λ_0, ρ_0, μ_1 and $\mu_{\mathcal{S}_2}$. As can be seen from Figure 4, these are the only non-trivial lower congruences on \mathcal{P}_n that are not joins of proper sub-congruences.

Proposition 5.8. *The relations $\rho_0, \lambda_0, \mu_1, \mu_{\mathcal{S}_2}$ are all principal congruences on \mathcal{P}_n . Moreover, if $\alpha, \beta \in \mathcal{P}_n$, then*

- (i) $\rho_0 = (\alpha, \beta)^\sharp \Leftrightarrow (\alpha, \beta) \in \rho_0 \setminus \Delta$, (iii) $\mu_1 = (\alpha, \beta)^\sharp \Leftrightarrow (\alpha, \beta) \in \mu_1 \setminus \Delta$,
(ii) $\lambda_0 = (\alpha, \beta)^\sharp \Leftrightarrow (\alpha, \beta) \in \lambda_0 \setminus \Delta$, (iv) $\mu_{\mathcal{S}_2} = (\alpha, \beta)^\sharp \Leftrightarrow (\alpha, \beta) \in \mu_{\mathcal{S}_2} \setminus \mu_1$.

Proof. The “only if” parts are clear for each statement. Before we prove (i), we note that (ii) will then follow by duality. Indeed, given (i),

$$\lambda_0 = (\alpha, \beta)^\sharp \Leftrightarrow \rho_0 = (\alpha^*, \beta^*)^\sharp \Leftrightarrow (\alpha^*, \beta^*) \in \rho_0 \setminus \Delta \Leftrightarrow (\alpha, \beta) \in \lambda_0 \setminus \Delta.$$

To prove (i), fix some $(\alpha, \beta) \in \rho_0 \setminus \Delta$ and, for simplicity, write $\xi = (\alpha, \beta)^\sharp$. For $\sigma \in \mathcal{P}_n$ with $\text{rank}(\sigma) = 0$, write σ' for the unique partition of rank 0 with $\ker(\sigma') = \ker(\sigma)$ and such that $\text{coker}(\sigma')$ is the trivial relation on \mathbf{n} . We first claim that $\sigma \xi \sigma'$ for all $\sigma \in \mathcal{P}_n$ with $\text{rank}(\sigma) = 0$. We prove the claim by descending induction on r , the number of cokernel-classes of σ . If $r = n$, then $\sigma = \sigma'$, so there is nothing to prove. So suppose $r \leq n - 1$, and write $\sigma = \left(\begin{array}{c|c|c} A_1 & \cdots & A_q \\ \hline B_1 & \cdots & B_r \end{array} \right)$. Since $\text{rank}(\alpha) = \text{rank}(\beta) = 0$ and $\ker(\alpha) = \ker(\beta)$, yet $\alpha \neq \beta$, it follows that $\text{coker}(\alpha) \neq \text{coker}(\beta)$. Reversing the roles of α and β , if necessary, we may assume that

there exists $(i, j) \in \text{coker}(\alpha) \setminus \text{coker}(\beta)$. Write $\mathbf{n} \setminus \{i, j\} = \{k_1, \dots, k_{n-2}\}$. Since $r \leq n-1$, we may assume that $|B_1| \geq 2$. Fix some $m \in B_1$, put $C = B_1 \setminus \{m\}$, and define $\tau = \begin{pmatrix} i & j & k_1 & \dots & k_{n-2} \\ m & C & B_2 & \dots & B_r \end{pmatrix}$. Then one easily checks that $\sigma\alpha\tau = \sigma$ and $\sigma\beta\tau = \begin{pmatrix} A_1 & A_2 & A_3 & \dots & A_r \\ m & C & B_2 & \dots & B_r \end{pmatrix}$. It follows that $\sigma = \sigma\alpha\tau \xi \sigma\beta\tau$. But $\text{rank}(\sigma\beta\tau) = 0$, $\ker(\sigma\beta\tau) = \ker(\sigma)$, and $\sigma\beta\tau$ has $r+1$ cokernel-classes so, by induction, $\sigma' \xi \sigma\beta\tau \xi \sigma$. This completes the proof of the claim. Returning to the main proof, suppose $(\gamma, \delta) \in \rho_0$ is arbitrary. If $\gamma = \delta$, then clearly $\gamma \xi \delta$. If $\gamma \neq \delta$, then $\text{rank}(\gamma) = \text{rank}(\delta) = 0$ and $\ker(\gamma) = \ker(\delta)$, so the claim gives $\gamma \xi \gamma' = \delta' \xi \delta$.

To prove (iii), let $(\alpha, \beta) \in \mu_1 \setminus \Delta$. Renaming α, β if necessary, we may assume that $\text{rank}(\alpha) = 1$, and we also have $\text{rank}(\beta) \leq 1$, $\ker(\alpha) = \ker(\beta)$, $\text{coker}(\alpha) = \text{coker}(\beta)$ but $\alpha \neq \beta$. Write $\alpha = \begin{pmatrix} A_0 & A_1 & \dots & A_r \\ B_0 & B_1 & \dots & B_s \end{pmatrix}$. Then, renaming $\ker(\alpha)$ -classes if necessary, one of the following holds:

$$\begin{aligned} \text{(a)} \quad \beta &= \begin{pmatrix} A_0 & A_1 & \dots & A_r \\ B_0 & B_1 & \dots & B_s \end{pmatrix}, & \text{(c)} \quad \beta &= \begin{pmatrix} A_0 & A_1 & \dots & A_r \\ B_s & B_0 & \dots & B_{s-1} \end{pmatrix} \text{ with } s \neq 0, \text{ or} \\ \text{(b)} \quad \beta &= \begin{pmatrix} A_r & A_0 & \dots & A_{r-1} \\ B_0 & B_1 & \dots & B_s \end{pmatrix} \text{ with } r \neq 0, & \text{(d)} \quad \beta &= \begin{pmatrix} A_r & A_0 & \dots & A_{r-1} \\ B_s & B_0 & \dots & B_{s-1} \end{pmatrix} \text{ with } r, s \neq 0. \end{aligned}$$

Choose some $i \in A_0$ and $j \in B_0$, and put $\sigma = \begin{bmatrix} i \\ i \end{bmatrix}$ and $\tau = \begin{bmatrix} j \\ j \end{bmatrix}$. In all cases, we have $\sigma\alpha\tau = \begin{bmatrix} i \\ j \end{bmatrix}$ and $\sigma\beta\tau = [\emptyset]$. In particular, $(\sigma\alpha\tau, \sigma\beta\tau) \in \overline{R}_1 \setminus \overline{\Delta}$, so Theorem 4.1 (and Remark 4.3) gives $\overline{R}_1 = (\sigma\alpha\tau, \sigma\beta\tau)_{\mathcal{I}_n}^\# \subseteq (\sigma\alpha\tau, \sigma\beta\tau)^\# \subseteq (\alpha, \beta)^\#$. Lemma 5.7(i) then gives $\mu_1 \subseteq (\alpha, \beta)^\#$, and the reverse containment is clear.

To prove (iv), let $(\alpha, \beta) \in \mu_{S_2} \setminus \mu_1 = \nu_{S_2} \setminus \Delta$, and write $\alpha = \begin{pmatrix} A_1 & A_2 & C_1 & \dots & C_r \\ B_1 & B_2 & D_1 & \dots & D_s \end{pmatrix}$ and $\beta = \begin{pmatrix} A_1 & A_2 & C_1 & \dots & C_r \\ B_2 & B_1 & D_1 & \dots & D_s \end{pmatrix}$. Choose any $a_i \in A_i$ and $b_i \in B_i$ ($i = 1, 2$), and put $\sigma = \begin{bmatrix} a_1 & a_2 \\ a_1 & a_2 \end{bmatrix}$ and $\tau = \begin{bmatrix} b_1 & b_2 \\ b_1 & b_2 \end{bmatrix}$. Then $\sigma\alpha\tau = \begin{bmatrix} a_1 & a_2 \\ b_1 & b_2 \end{bmatrix}$ and $\sigma\beta\tau = \begin{bmatrix} a_1 & a_2 \\ b_2 & b_1 \end{bmatrix}$. In particular, $(\sigma\alpha\tau, \sigma\beta\tau) \in \overline{R}_{S_2} \setminus \overline{R}_1$, so Theorem 4.1 (and Remark 4.3) gives $\overline{R}_{S_2} = (\sigma\alpha\tau, \sigma\beta\tau)_{\mathcal{I}_n}^\# \subseteq (\alpha, \beta)^\#$. Lemma 5.7(ii) then gives $\mu_{S_2} \subseteq (\alpha, \beta)^\#$, and again this is enough. \square

Next we move onto the remaining four lower principal congruences.

Proposition 5.9. *The congruences R_0, ρ_1, λ_1 and R_1 are all principal. Moreover, if $\alpha, \beta \in \mathcal{P}_n$, then*

$$\begin{aligned} \text{(i)} \quad R_0 &= (\alpha, \beta)^\# \Leftrightarrow (\alpha, \beta) \in R_0 \setminus (\rho_0 \cup \lambda_0), & \text{(iii)} \quad \lambda_1 &= (\alpha, \beta)^\# \Leftrightarrow (\alpha, \beta) \in \lambda_1 \setminus (\mu_1 \cup \lambda_0), \\ \text{(ii)} \quad \rho_1 &= (\alpha, \beta)^\# \Leftrightarrow (\alpha, \beta) \in \rho_1 \setminus (\mu_1 \cup \rho_0), & \text{(iv)} \quad R_1 &= (\alpha, \beta)^\# \Leftrightarrow (\alpha, \beta) \in R_1 \setminus (R_0 \cup \lambda_1 \cup \rho_1). \end{aligned}$$

Proof. Again, the ‘‘only if’’ parts are obvious. Beginning with (i), suppose $(\alpha, \beta) \in R_0 \setminus (\rho_0 \cup \lambda_0)$, and write $\alpha = \begin{pmatrix} A_1 & \dots & A_r \\ B_1 & \dots & B_s \end{pmatrix}$ and $\beta = \begin{pmatrix} C_1 & \dots & C_t \\ D_1 & \dots & D_u \end{pmatrix}$, noting that $\ker(\alpha) \neq \ker(\beta)$ and $\text{coker}(\alpha) \neq \text{coker}(\beta)$. By Proposition 3.27(i), $R_0 = \rho_0 \vee \lambda_0$, so it is enough to prove that $(\alpha, \beta)^\#$ contains both ρ_0 and λ_0 . Put $\gamma = \begin{pmatrix} A_1 & \dots & A_r \\ D_1 & \dots & D_u \end{pmatrix}$. Then $(\alpha, \gamma) = (\gamma\alpha, \gamma\beta) \in \rho_0 \setminus \Delta$, so Proposition 5.8(i) gives $\rho_0 = (\alpha, \gamma)^\# \subseteq (\alpha, \beta)^\#$. Similarly, $\lambda_0 = (\gamma, \beta)^\# = (\alpha\gamma, \beta\gamma)^\# \subseteq (\alpha, \beta)^\#$.

Next we prove (ii), and we note that (iii) will then follow by duality. Suppose $(\alpha, \beta) \in \rho_1 \setminus (\mu_1 \cup \rho_0)$. Renaming α, β if necessary, we may assume that $\text{rank}(\alpha) = 1$, and we write $\alpha = \begin{pmatrix} A_0 & A_1 & \dots & A_r \\ B_0 & B_1 & \dots & B_s \end{pmatrix}$. Since $\text{rank}(\beta) \leq 1$ and $\ker(\alpha) = \ker(\beta)$, we may write

$$\text{(a)} \quad \beta = \begin{pmatrix} A_0 & A_1 & \dots & A_r \\ C_0 & C_1 & \dots & C_t \end{pmatrix}, \text{ or} \quad \text{(b)} \quad \beta = \begin{pmatrix} A_r & A_0 & \dots & A_{r-1} \\ C_0 & C_1 & \dots & C_t \end{pmatrix}, \text{ where } r \neq 0, \text{ or} \quad \text{(c)} \quad \beta = \begin{pmatrix} A_0 & A_1 & \dots & A_r \\ C_0 & C_1 & \dots & C_t \end{pmatrix}.$$

Since $(\alpha, \beta) \notin \mu_1$, we have $\text{coker}(\alpha) \neq \text{coker}(\beta)$. In any of cases (a)–(c), put $\gamma = \begin{pmatrix} A_0 & A_1 & \dots & A_r \\ A_0 & A_1 & \dots & A_r \end{pmatrix}$. Then $(\gamma\alpha, \gamma\beta) \in (\alpha, \beta)^\#$, with $\gamma\alpha = \begin{pmatrix} A_0 & A_1 & \dots & A_r \\ B_0 & B_1 & \dots & B_s \end{pmatrix}$ and $\gamma\beta = \begin{pmatrix} A_0 & A_1 & \dots & A_r \\ C_0 & C_1 & \dots & C_t \end{pmatrix}$. In particular, $(\gamma\alpha, \gamma\beta) \in \rho_0 \setminus \Delta$, so Proposition 5.8(i) gives $\rho_0 = (\gamma\alpha, \gamma\beta)^\# \subseteq (\alpha, \beta)^\#$. To complete the proof of (ii), since $\rho_1 = \mu_1 \vee \rho_0$ (by Proposition 3.28), it suffices to show that $\mu_1 \subseteq (\alpha, \beta)^\#$. To do this, we consider cases (a)–(c) separately.

First, suppose (a) holds. We consider two separate subcases. If $B_0 \neq C_0$, then (reversing the roles of α and β , if necessary) choose some $i \in B_0 \setminus C_0$, write $\mathbf{n} \setminus \{i\} = \{i_1, \dots, i_{n-1}\}$, let $\delta = \begin{bmatrix} i \\ i \end{bmatrix}$, and note that $\alpha\delta = \begin{pmatrix} A_0 & A_1 & \dots & A_r \\ i & i_1 & \dots & i_{n-1} \end{pmatrix}$ and $\beta\delta = \begin{pmatrix} A_0 & A_1 & \dots & A_r \\ i & i_1 & \dots & i_{n-1} \end{pmatrix}$. On the other hand, if $B_0 = C_0$, then (reversing the roles of α and β , if necessary) choose some $i \in B_0 = C_0$, some $j, k \in \mathbf{n}$ with $(j, k) \in \text{coker}(\alpha) \setminus \text{coker}(\beta)$,

write $\mathbf{n} \setminus \{i, j, k\} = \{j_1, \dots, j_{n-3}\}$, let $\delta = \left(\begin{array}{c|c|c|c} k & i, j & j_1 & \dots & j_{n-3} \\ \hline k & i, j & j_1 & \dots & j_{n-3} \end{array} \right)$, and note that $\alpha\delta = \left(\begin{array}{c|c|c|c} A_0 & A_1 & A_2 & \dots & A_r \\ \hline k & i, j & j_1 & \dots & j_{n-3} \end{array} \right)$ and $\beta\delta = \left(\begin{array}{c|c|c|c} A_0 & A_1 & A_2 & \dots & A_r \\ \hline k & i, j & j_1 & \dots & j_{n-3} \end{array} \right)$. In either subcase, Proposition 5.8(iii) gives $\mu_1 = (\alpha\delta, \beta\delta)^\# \subseteq (\alpha, \beta)^\#$.

Next, suppose (b) holds. Again, we consider two separate subcases. If $B_0 \cap C_0 \neq \emptyset$, then choose some $i \in B_0 \cap C_0$, write $\mathbf{n} \setminus \{i\} = \{i_1, \dots, i_{n-1}\}$, let $\delta = \left(\begin{array}{c|c|c} i & i_1 & \dots & i_{n-1} \\ \hline B_0 & B_1 & \dots & B_s \end{array} \right)$, and note that $\alpha\delta = \alpha$ and $\beta\delta = \left(\begin{array}{c|c|c} A_r & A_0 & \dots & A_{r-1} \\ \hline B_0 & B_1 & \dots & B_s \end{array} \right)$. On the other hand, if $B_0 \cap C_0 = \emptyset$, choose some $i \in B_0$ and $j \in C_0$, write $\mathbf{n} \setminus \{i, j\} = \{j_1, \dots, j_{n-2}\}$, let $\delta = \left(\begin{array}{c|c} i & j \\ \hline i & j \end{array} \right)$, and note that $\alpha\delta = \left(\begin{array}{c|c|c|c} A_0 & A_1 & A_2 & \dots & A_r \\ \hline i & j & j_1 & \dots & j_{n-2} \end{array} \right)$ and $\beta\delta = \left(\begin{array}{c|c|c|c} A_r & A_0 & A_1 & \dots & A_{r-1} \\ \hline j & i & j_1 & \dots & j_{n-2} \end{array} \right)$. In either case, $(\alpha\delta, \beta\delta) \in \mu_1 \setminus \Delta$, so Proposition 5.8(iii) gives $\mu_1 = (\alpha\delta, \beta\delta)^\# \subseteq (\alpha, \beta)^\#$.

Finally, if (c) holds, then $\beta(\alpha^*\alpha) = \widehat{\alpha}$, and Proposition 5.8(iii) gives $\mu_1 = (\alpha, \widehat{\alpha})^\# = (\alpha\alpha^*\alpha, \beta\alpha^*\alpha)^\# \subseteq (\alpha, \beta)^\#$. This completes the proof of (ii).

For (iv), suppose $(\alpha, \beta) \in R_1 \setminus (R_0 \cup \rho_1 \cup \lambda_1)$. Renaming α, β if necessary, we may assume that

$$\text{rank}(\alpha) = 1, \quad \text{rank}(\beta) \leq 1, \quad \ker(\alpha) \neq \ker(\beta), \quad \text{coker}(\alpha) \neq \text{coker}(\beta).$$

Write $\alpha = \left(\begin{array}{c|c|c|c} A_0 & A_1 & \dots & A_r \\ \hline B_0 & B_1 & \dots & B_s \end{array} \right)$ and $\beta = \left(\begin{array}{c|c|c|c} C_0 & C_1 & \dots & C_t \\ \hline D_0 & D_1 & \dots & D_u \end{array} \right)$ or $\left(\begin{array}{c|c|c|c} C_0 & C_1 & \dots & C_t \\ \hline D_0 & D_1 & \dots & D_u \end{array} \right)$. Since $\rho_1 \vee \lambda_1 = R_1$, by Proposition 3.27(i), to prove that $(\alpha, \beta)^\# = R_1$, it suffices to show that $(\alpha, \beta)^\#$ contains ρ_1 and λ_1 . We just show the first of these, as the second is dual. One of the following three statements must hold:

$$(d) \text{ rank}(\beta) = 0, \quad \text{or} \quad (e) \text{ rank}(\beta) = 1 \text{ and } A_0 = C_0, \quad \text{or} \quad (f) \text{ rank}(\beta) = 1 \text{ and } A_0 \neq C_0.$$

Suppose first that (d) or (e) holds. We then define $\gamma = \left(\begin{array}{c|c|c|c} A_0 & A_1 & \dots & A_r \\ \hline A_0 & A_1 & \dots & A_r \end{array} \right)$, and note that $\gamma\alpha = \alpha$ and $\gamma\beta = \left(\begin{array}{c|c|c|c} A_0 & A_1 & \dots & A_r \\ \hline D_0 & D_1 & \dots & D_u \end{array} \right)$ or $\left(\begin{array}{c|c|c|c} A_0 & A_1 & \dots & A_r \\ \hline D_0 & D_1 & \dots & D_u \end{array} \right)$. In either case, we see that $(\alpha, \gamma\beta)^\# = (\gamma\alpha, \gamma\beta)^\# \subseteq (\alpha, \beta)^\#$, while $(\alpha, \gamma\beta)^\# = \rho_1$ follows from case (ii), proved above.

Now suppose (f) holds. Reversing the roles of α and β , if necessary, we may choose some $i \in A_0 \setminus C_0$. Write $\mathbf{n} \setminus \{i\} = \{i_1, \dots, i_{n-1}\}$, and let $\gamma = \left(\begin{array}{c} i \\ \hline i \end{array} \right)$. Then $\gamma\alpha = \left(\begin{array}{c|c|c|c} i & i_1 & \dots & i_{n-1} \\ \hline B_0 & B_1 & \dots & B_s \end{array} \right)$ and $\gamma\beta = \left(\begin{array}{c|c|c|c} i & i_1 & \dots & i_{n-1} \\ \hline D_0 & D_1 & \dots & D_u \end{array} \right)$. In particular, $\rho_1 = (\gamma\alpha, \gamma\beta)^\# \subseteq (\alpha, \beta)^\#$, again using part (ii). \square

Remark 5.10. The congruences λ_{S_2} , ρ_{S_2} and R_{S_2} are not principal (cf. Remark 3.26). However, each of them is generated by two pairs of partitions, and these generating sets (up to reordering) are as follows:

- (i) $\rho_{S_2} = \{(\alpha, \beta), (\gamma, \delta)\}^\# \Leftrightarrow (\alpha, \beta) \in \rho_{S_2} \setminus \rho_1$ and $(\gamma, \delta) \in \rho_{S_2} \setminus \mu_{S_2}$,
- (ii) $\lambda_{S_2} = \{(\alpha, \beta), (\gamma, \delta)\}^\# \Leftrightarrow (\alpha, \beta) \in \lambda_{S_2} \setminus \lambda_1$ and $(\gamma, \delta) \in \lambda_{S_2} \setminus \mu_{S_2}$,
- (iii) $R_{S_2} = \{(\alpha, \beta), (\gamma, \delta)\}^\# \Leftrightarrow (\alpha, \beta) \in R_{S_2} \setminus R_1$ and $(\gamma, \delta) \in R_{S_2} \setminus (\lambda_{S_2} \cup \rho_{S_2})$.

The forwards implications of these assertions are easily proved, using $\rho_{S_2} = \mu_{S_2} \cup \rho_1$, $\lambda_{S_2} = \mu_{S_2} \cup \lambda_1$ and $R_{S_2} = R_1 \cup \lambda_{S_2} = R_1 \cup \rho_{S_2}$. The converses follow by combinations of facts proved in Propositions 5.8 and 5.9, but we leave it to the reader to verify this, as it does not play an important role in what follows.

Finally, we turn our attention to the upper congruences. Specifically, we consider the chain of relations

$$R_{S_2} \subsetneq R_2 \subsetneq R_{A_3} \subsetneq R_{S_3} \subsetneq R_3 \subsetneq R_K \subsetneq R_{A_4} \subsetneq R_{S_4} \subsetneq R_4 \subsetneq R_{A_5} \subsetneq R_{S_5} \subsetneq R_5 \subsetneq \dots \subsetneq R_{S_n} \subsetneq R_n = \nabla. \quad (5.11)$$

For an arbitrary member ξ of this chain other than R_{S_2} , let ξ^- be its immediate predecessor in the chain. We aim to show that every such ξ is generated by any pair from $\xi \setminus \xi^-$. We proceed via a sequence of lemmas.

Lemma 5.12. *For every $\alpha \in \mathcal{P}_n$, there exists $\beta \in \mathcal{I}_n$ with $\text{rank}(\beta) = \text{rank}(\alpha)$, $\alpha = \alpha\beta\alpha$ and $\beta = \beta\alpha\beta$.*

Proof. If $\alpha = \left(\begin{array}{c|c|c|c} A_1 & \dots & A_q & C_1 & \dots & C_r \\ \hline B_1 & \dots & B_q & D_1 & \dots & D_s \end{array} \right)$, pick $a_i \in A_i$, $b_i \in B_i$ ($i = 1, \dots, q$), and define $\beta = \left[\begin{array}{c|c} b_1 & \dots & b_q \\ \hline a_1 & \dots & a_q \end{array} \right]$. Verification of the stated properties is immediate. \square

Lemma 5.13. *Let $\alpha, \beta \in J_q$ with $q \geq 1$.*

- (i) *If $(\alpha, \beta) \notin \mathcal{R}$, then there exists $\gamma \in J_q$ such that precisely one of $\gamma\alpha, \gamma\beta$ belongs to J_q .*
- (ii) *If $(\alpha, \beta) \notin \mathcal{L}$, then there exists $\gamma \in J_q$ such that precisely one of $\alpha\gamma, \beta\gamma$ belongs to J_q .*

Proof. By duality, it suffices to prove (i), so suppose $(\alpha, \beta) \notin \mathcal{R}$, and write $\alpha = \left(\begin{array}{c|ccc} A_1 & \cdots & A_q & C_1 \cdots C_r \\ \hline B_1 & \cdots & B_q & D_1 \cdots D_s \end{array} \right)$ and $\beta = \left(\begin{array}{c|ccc} E_1 & \cdots & E_q & G_1 \cdots G_t \\ \hline F_1 & \cdots & F_q & H_1 \cdots H_u \end{array} \right)$. Since $(\alpha, \beta) \notin \mathcal{R}$, either $\text{dom}(\alpha) \neq \text{dom}(\beta)$ or $\ker(\alpha) \neq \ker(\beta)$.

Case 1. Suppose first that $\text{dom}(\alpha) \neq \text{dom}(\beta)$. Without loss of generality, we may assume that $A_1 \setminus \text{dom}(\beta)$ is nonempty. Let $a_1 \in A_1 \setminus \text{dom}(\beta), a_2 \in A_2, \dots, a_q \in A_q$, and let $\gamma = \left[\begin{array}{c} a_1 \\ \vdots \\ a_q \end{array} \right]$. Then $\text{rank}(\gamma\alpha) = q$ and $\text{rank}(\gamma\beta) < q$; the latter is the case because $\text{dom}(\gamma\beta) \subseteq \text{dom}(\gamma) = \{a_1, \dots, a_q\}$, yet $a_1 \notin \text{dom}(\gamma\beta)$.

Case 2. Next suppose $\text{dom}(\alpha) = \text{dom}(\beta)$, but $\ker(\alpha) \neq \ker(\beta)$. Without loss of generality, we may assume that there exists some $(i, j) \in \ker(\alpha) \setminus \ker(\beta)$, and that either $i, j \in A_1$ or $i, j \in C_1$.

Subcase 2.1. Suppose $i, j \in A_1$. Since $i, j \in \text{dom}(\alpha) = \text{dom}(\beta)$ and $(i, j) \notin \ker(\beta)$, we may assume without loss of generality that $i \in E_1$ and $j \in E_2$. For each $3 \leq p \leq q$, choose some $e_p \in E_p$, and put $e_1 = i$ and $e_2 = j$. Define $\gamma = \left[\begin{array}{c} e_1 \\ \vdots \\ e_q \end{array} \right]$. Then $\text{rank}(\gamma\beta) = q$ and $\text{rank}(\gamma\alpha) < q$; the latter is the case because $(i, j) \in \ker(\gamma\alpha)$ and $i, j \in \text{dom}(\gamma\alpha) = \{e_1, \dots, e_q\}$.

Subcase 2.2. Finally, suppose $i, j \in C_1$. For each $1 \leq p \leq q$, choose some $a_p \in A_p$. Write $\mathbf{n} \setminus \{a_1, \dots, a_q\} = \{x_1, \dots, x_{n-q}\}$, assuming that $x_1 = i$ and $x_2 = j$, and put $\gamma = \left(\begin{array}{c|ccc} a_1 & \cdots & a_{q-1} & i \left[\begin{array}{c} a_q, j \\ x_3 \\ \vdots \\ x_{n-q} \end{array} \right] \\ \hline a_1 & \cdots & a_{q-1} & i \left[\begin{array}{c} a_q, j \\ x_3 \\ \vdots \\ x_{n-q} \end{array} \right] \end{array} \right)$. Then $\text{rank}(\gamma\alpha) = q$ and $\text{rank}(\gamma\beta) < q$; the latter is the case because $\{i\}$ is a singleton block of $\gamma\beta$, and $\text{dom}(\gamma\beta) \subseteq \text{dom}(\gamma) = \{a_1, \dots, a_{q-1}, i\}$. \square

The next result concerns the permutations $\phi(\alpha, \beta)$ from Definition 5.5, and the symmetric inverse monoid $\mathcal{I}_n \subseteq \mathcal{P}_n$.

Lemma 5.14. *For any $(\alpha, \beta) \in \mathcal{H} \cap (J_q \times J_q)$ with $q \geq 1$, there exist $\alpha_1, \beta_1, \gamma_1, \delta_1 \in J_q(\mathcal{I}_n)$ and $\gamma_2, \delta_2 \in J_q$ such that*

- (i) $(\alpha_1, \beta_1) = (\gamma_1\alpha\delta_1, \gamma_1\beta\delta_1) \in \mathcal{H}$,
- (ii) $\phi(\alpha_1, \beta_1) = \phi(\alpha, \beta)$,
- (iii) $(\alpha, \beta) = (\gamma_2\alpha_1\delta_2, \gamma_2\beta_1\delta_2)$.

Proof. Write $\alpha = \left(\begin{array}{c|ccc} A_1 & \cdots & A_q & C_1 \cdots C_r \\ \hline B_{1\sigma} & \cdots & B_{q\sigma} & D_1 \cdots D_s \end{array} \right)$ and $\beta = \left(\begin{array}{c|ccc} A_1 & \cdots & A_q & C_1 \cdots C_r \\ \hline B_{1\tau} & \cdots & B_{q\tau} & D_1 \cdots D_s \end{array} \right)$, where $\min(A_1) < \dots < \min(A_q)$, $\min(B_1) < \dots < \min(B_q)$ and $\sigma, \tau \in \mathcal{S}_k$. For each $1 \leq i \leq q$, put $a_i = \min(A_i)$ and $b_i = \min(B_i)$. Then $\gamma_1 = \left[\begin{array}{c} a_1 \\ \vdots \\ a_q \end{array} \right], \delta_1 = \left[\begin{array}{c} b_1 \\ \vdots \\ b_q \end{array} \right], \gamma_2 = \left(\begin{array}{c|ccc} A_1 & \cdots & A_q & C_1 \cdots C_r \\ \hline A_1 & \cdots & A_q & C_1 \cdots C_r \end{array} \right)$ and $\delta_2 = \left(\begin{array}{c|ccc} B_1 & \cdots & B_q & D_1 \cdots D_s \\ \hline B_1 & \cdots & B_q & D_1 \cdots D_s \end{array} \right)$ have the desired properties. \square

Recall that for any congruence ξ on \mathcal{P}_n , we write $\bar{\xi} = \xi \cap (\mathcal{I}_n \times \mathcal{I}_n)$ for the induced congruence on \mathcal{I}_n .

Lemma 5.15. *Let ξ be any of the congruences from the chain (5.11) other than $R_{\mathcal{S}_2}$. Then $\xi = \bar{\xi}^\sharp$.*

Proof. Since $\bar{\xi} \subseteq \xi$, the inclusion $\bar{\xi}^\sharp \subseteq \xi$ is clear, so only the converse needs to be proved.

Case 1. Suppose first that $\xi = R_q$ for some $q \geq 2$. We begin by showing that $R_0 \subseteq \bar{\xi}^\sharp$. To do so, let $\alpha = \left[\begin{array}{c} 1 \\ 2 \end{array} \right], \beta = [\emptyset]$ and $\sigma = \left(\begin{array}{c|ccc} 12 & 3 & \cdots & n \\ \hline 12 & 3 & \cdots & n \end{array} \right)$. Now $(\alpha, \beta) \in \bar{R}_2 \subseteq \bar{\xi}$, so it follows that $(\sigma, \beta) = (\alpha\sigma\alpha, \beta\sigma\beta) \in \bar{\xi}^\sharp$. But $(\sigma, \beta) \in R_0 \setminus (\rho_0 \cup \lambda_0)$, so Proposition 5.9(i) gives $R_0 = (\sigma, \beta)^\sharp \subseteq \bar{\xi}^\sharp$. To complete the proof that $\xi = R_q \subseteq \bar{\xi}^\sharp$, it suffices to show that every partition of rank at most q is $\bar{\xi}^\sharp$ -related to a partition of rank 0. So let $\gamma \in \mathcal{P}_n$ with $\text{rank}(\gamma) = p \leq q$. By Lemma 5.12, there exists $\delta \in \mathcal{I}_n$ with $\text{rank}(\delta) = p$ such that $\gamma = \gamma\delta\gamma$. But then with $\beta = [\emptyset]$ as above, we have $(\delta, \beta) \in \bar{R}_q \subseteq \bar{\xi}$, so that $(\gamma, \gamma\beta\gamma) = (\gamma\delta\gamma, \gamma\beta\gamma) \in \bar{\xi}^\sharp$. Since $\text{rank}(\gamma\beta\gamma) = 0$, the proof is complete in this case.

Case 2. Now suppose $\xi = R_N$ for some non-trivial normal subgroup N of \mathcal{S}_q , where $q \geq 3$. Now, $R_{q-1} = \overline{R}_{q-1}^\# \subseteq \xi^\#$ by Case 1, so it remains to show that $R_N \setminus R_{q-1} \subseteq \xi^\#$. Let $(\alpha, \beta) \in R_N \setminus R_{q-1} = \nu_N \setminus \Delta$ be arbitrary. So $\text{rank}(\alpha) = \text{rank}(\beta) = q$, $\alpha \not\mathcal{H} \beta$ and $\phi(\alpha, \beta) \in N$. Let $\alpha_1, \beta_1, \gamma_1, \delta_1 \in J_q(\mathcal{I}_n)$ and $\gamma_2, \delta_2 \in J_q$ be as in Lemma 5.14. Then $(\alpha_1, \beta_1) \in \overline{R}_N = \overline{\xi}$, and it follows that $(\alpha, \beta) = (\gamma_2 \alpha_1 \delta_2, \gamma_2 \beta_1 \delta_2) \in \xi^\#$. \square

The next result is the final step required to complete the proof of Theorem 5.4.

Proposition 5.16. *Consider the chain (5.11) of congruences on \mathcal{P}_n , and let ξ be any of these congruences other than $R_{\mathcal{S}_2}$. Then ξ is a principal congruence on \mathcal{P}_n . Moreover, if $\alpha, \beta \in \mathcal{P}_n$, then $\xi = (\alpha, \beta)^\#$ if and only if $(\alpha, \beta) \in \xi \setminus \xi^-$, where ξ^- denotes the congruence immediately preceding ξ in the chain (5.11).*

Proof. The “only if” part being clear, suppose $(\alpha, \beta) \in \xi \setminus \xi^-$. We must show that $\xi \subseteq (\alpha, \beta)^\#$. In fact, by Lemma 5.15, it is enough to show that $\overline{\xi} \subseteq (\alpha, \beta)^\#$.

Case 1. Suppose first that $\xi = R_q$ for some $q \geq 2$, so that $\xi^- = R_{\mathcal{S}_q}$. Renaming if necessary, we may assume that $\text{rank}(\alpha) = q$. We also have either $\text{rank}(\beta) < q$ or else $\text{rank}(\beta) = q$ but $(\alpha, \beta) \notin \mathcal{H}$, since the condition “ $\phi(\alpha, \beta) \in N$ ” is trivially satisfied when $N = \mathcal{S}_q$ (cf. Definition 3.14 and Lemma 5.6).

Subcase 1.1. Now suppose $\text{rank}(\beta) = p < q$. By Lemma 5.12, there exists $\gamma \in \mathcal{I}_n$ with $\text{rank}(\gamma) = q$ such that $\gamma\alpha\gamma = \gamma$. Since $\text{rank}(\gamma\beta\gamma) \leq \text{rank}(\beta) = p < q$, and since $(\gamma\alpha\gamma, \gamma\beta\gamma) \in (\alpha, \beta)^\#$, we may assume without loss of generality that $\alpha \in \mathcal{I}_n$. By Lemma 5.12 again, there exists $\delta \in \mathcal{I}_n$ with $\text{rank}(\delta) = p$ and $\beta = \beta\delta\beta$. Writing $\zeta = (\alpha, \beta)^\#$, we then have $\alpha \zeta \beta = \beta\delta\beta \zeta \alpha\delta\alpha$. But $\alpha\delta\alpha \in \mathcal{I}_n$ and $\text{rank}(\alpha\delta\alpha) \leq \text{rank}(\delta) < q$, so $(\alpha, \alpha\delta\alpha) \in \overline{R}_q \setminus \overline{R}_{\mathcal{S}_q}$. It then follows from Theorem 4.1 (and Remark 4.3) that $\overline{R}_q = (\alpha, \alpha\delta\alpha)_{\mathcal{I}_n}^\# \subseteq \zeta = (\alpha, \beta)^\#$, as required.

Subcase 1.2. Suppose $\text{rank}(\beta) = q$ and $(\alpha, \beta) \notin \mathcal{H}$. Without loss of generality, we may assume that $(\alpha, \beta) \notin \mathcal{R}$. By Lemma 5.13(i), and renaming α, β if necessary, there exists $\gamma \in \mathcal{P}_n$ with $\text{rank}(\gamma\alpha) < q = \text{rank}(\gamma\beta)$. But then by Subcase 1.1, $\overline{R}_q = (\gamma\alpha, \gamma\beta)^\# \subseteq (\alpha, \beta)^\#$.

Case 2. Suppose $\xi = R_N$ for some non-trivial normal subgroup N of \mathcal{S}_q , where $q \geq 3$. Let H be the largest normal subgroup of \mathcal{S}_q properly contained in N , and note that $\xi^- = R_H$. (For the case where N is the smallest non-trivial normal subgroup of \mathcal{S}_q , recall that $R_{\{\text{id}_q\}} = R_{q-1}$.) Because $(\alpha, \beta) \in R_N \setminus R_H$, we have $\text{rank}(\alpha) = \text{rank}(\beta) = q$, $\alpha \not\mathcal{H} \beta$ and $\phi(\alpha, \beta) \in N \setminus H$. Let $\alpha_1, \beta_1, \gamma_1, \delta_1$ be as in Lemma 5.14. Then, from the conclusions of that lemma, it follows that $(\alpha_1, \beta_1) \in (\overline{R}_N \setminus \overline{R}_H) \cap (\alpha, \beta)^\#$. It follows from Theorem 4.1 (and Remark 4.3) that $\overline{R}_N = (\alpha_1, \beta_1)_{\mathcal{I}_n}^\# \subseteq (\alpha, \beta)^\#$, completing the proof. \square

Now that the proof of Theorem 5.4 is complete, we conclude this section by noting that it is easy to derive a description of the lattice $\text{Cong}^*(\mathcal{P}_n)$ of $*$ -congruences on \mathcal{P}_n . Indeed, to do this, we just need to check which of the congruences of \mathcal{P}_n are also compatible with the unary operation $\alpha \mapsto \alpha^*$. It turns out that most of them do, with the exception of the “left/right” congruences $\lambda_0, \lambda_1, \lambda_{\mathcal{S}_2}, \rho_1, \rho_2, \rho_{\mathcal{S}_2}$.

Corollary 5.17. *For $n \geq 2$, $\text{Cong}^*(\mathcal{P}_n) = \text{Cong}(\mathcal{P}_n) \setminus \{\lambda_0, \lambda_1, \lambda_{\mathcal{S}_2}, \rho_1, \rho_2, \rho_{\mathcal{S}_2}\}$. Theorem 5.4 describes the congruence lattice $\text{Cong}(\mathcal{P}_n)$. The Hasse diagram of $\text{Cong}^*(\mathcal{P}_n)$ is shown in Figure 4.*

Proof. By Remark 2.2(i), $\alpha \mathcal{J} \alpha^*$ for any $\alpha \in \mathcal{P}_n$, and hence the Rees congruences R_q are $*$ -compatible. Furthermore, from Definition 3.14, it easily follows that $\alpha \mapsto \alpha^*$ preserves the relation ν_N (for any normal subgroup N of \mathcal{S}_q), whence the congruences R_N are also $*$ -compatible. Next, note that the retraction f from Definition 5.1 agrees with the involution, in the sense that $\alpha^* f = (\alpha f)^*$; therefore the relations $\mu_0, \mu_1, \mu_{\mathcal{S}_2}$ are $*$ -compatible. Finally, by Remark 2.2(i), we have that $\alpha \mapsto \alpha^*$ maps \mathcal{R} -classes of \mathcal{P}_n to \mathcal{L} -classes, and vice versa, and hence the congruences $\lambda_0, \lambda_1, \lambda_{\mathcal{S}_2}, \rho_1, \rho_2, \rho_{\mathcal{S}_2}$ are not $*$ -compatible. \square

6 The partial Brauer monoid \mathcal{PB}_n

The goal of this section is to give a brief treatment of the congruence lattice of the partial Brauer monoid \mathcal{PB}_n , which, recall, consists of all partitions with blocks of sizes ≤ 2 . In a nutshell, the lattice is isomorphic to that of \mathcal{P}_n , and the proof is almost identical to the one for \mathcal{P}_n given in the previous section.

To verify this, we must first check that all the ingredients needed to define various congruences forming the lattice shown in Figure 4 are present in the context of the \mathcal{PB}_n . Indeed, \mathcal{PB}_n has $n + 1$ ideals and

\mathcal{J} -classes, I_q and J_q respectively, indexed by the available ranks $q = 0, \dots, n$. They give rise to the Rees congruences R_q (Definition 3.1). Next, the map $\mathcal{S}_q \rightarrow \mathcal{P}_n : \sigma \mapsto \bar{\sigma} = \begin{bmatrix} 1 & \cdots & q \\ 1\sigma & \cdots & q\sigma \end{bmatrix}$, discussed in Section 4, maps into \mathcal{PB}_n , so for every normal subgroup N of \mathcal{S}_q for $q \geq 1$, we have an IN-pair (I_{q-1}, \overline{N}) , giving rise to the congruence $R_N = R_{I_{q-1}, \overline{N}}$ (Definition 3.16).

The next step is to note that the retraction $f : \mathcal{P}_n \rightarrow \mathcal{P}_n : \alpha \mapsto \hat{\alpha}$ of \mathcal{P}_n , given in Definition 5.1, maps \mathcal{PB}_n into \mathcal{PB}_n . Indeed, $\hat{\alpha}$ is obtained by “breaking” the transversals of α into two, thereby reducing their size, and leaving the non-transversals alone. Thus, I_1 is retractable (and, as with \mathcal{P}_n , no larger ideal of \mathcal{PB}_n is retractable). Finally, we have three retractable IN-pairs $\mathcal{C}_0 = (I_0, \{\overline{id}_1\})$, $\mathcal{C}_1 = (I_1, \{\overline{id}_2\})$, $\mathcal{C}_{\mathcal{S}_2} = (I_1, \overline{\mathcal{S}_2})$, giving rise to nine λ, ρ, μ congruences.

Theorem 6.1. *Let $n \geq 2$, and let \mathcal{PB}_n be the partial Brauer monoid of degree n .*

- (i) *The ideals of \mathcal{PB}_n are the sets I_q , for $q = 0, \dots, n$, yielding the Rees congruences $R_q = R_{I_q}$, as in Definition 3.1.*
- (ii) *The proper IN-pairs of \mathcal{PB}_n are of the form (I_{q-1}, \overline{N}) , for $q = 2, \dots, n$ and for any non-trivial normal subgroup N of \mathcal{S}_q , yielding the congruences $R_N = R_{I_{q-1}, \overline{N}}$, as in Definition 3.16.*
- (iii) *The retractable IN-pairs of \mathcal{PB}_n are $\mathcal{C}_0 = (I_0, \{\overline{id}_1\})$, $\mathcal{C}_1 = (I_1, \{\overline{id}_2\})$ and $\mathcal{C}_{\mathcal{S}_2} = (I_1, \overline{\mathcal{S}_2})$, yielding the congruences $\lambda_0, \rho_0, \mu_0, \lambda_1, \rho_1, \mu_1, \lambda_{\mathcal{S}_2}, \rho_{\mathcal{S}_2}, \mu_{\mathcal{S}_2}$, respectively, as in Definition 3.18.*
- (iv) *The above congruences are distinct, and they exhaust all the congruences of \mathcal{PB}_n .*
- (v) *The $*$ -congruences are the same, but with $\lambda_0, \lambda_1, \lambda_{\mathcal{S}_2}, \rho_0, \rho_1, \rho_{\mathcal{S}_2}$ excluded.*
- (vi) *The Hasse diagrams of the congruence and $*$ -congruence lattices $\text{Cong}(\mathcal{PB}_n)$ and $\text{Cong}^*(\mathcal{PB}_n)$ are shown in Figure 4.*

The proof now proceeds in exactly the same way as the Proof of Theorem 5.4. The reader only needs to be alert that every time a partition is constructed, it is necessary to verify that it belongs to \mathcal{PB}_n (on the assumption, of course, that all the previous partitions came from this monoid too).

Thus, for example, in the proof of Lemma 5.7(i), given a partition $\alpha = \begin{pmatrix} A_0 & A_1 & \cdots & A_r \\ B_0 & B_1 & \cdots & B_s \end{pmatrix}$, four new partitions are constructed:

$$\gamma = \begin{pmatrix} A_0 & A_1 & \cdots & A_r \\ 1 & 2 & \cdots & n \end{pmatrix}, \quad \delta = \begin{pmatrix} 1 & 2 & \cdots & n \\ B_0 & B_1 & \cdots & B_s \end{pmatrix}, \quad \sigma = \begin{bmatrix} 1 \\ 1 \end{bmatrix}, \quad \tau = [\emptyset].$$

Now, γ has the same upper blocks as α , and lower blocks of size 1; similarly, δ has lower blocks equal to those of α and upper blocks of size 1. Hence, if $\alpha \in \mathcal{PB}_n$, then $\gamma, \delta \in \mathcal{PB}_n$, and also $\sigma, \tau \in \mathcal{I}_n \subseteq \mathcal{PB}_n$. Checks like this need to be performed throughout the proof, but they are no harder than the above example. One last small thing perhaps worthy of mention is that in the proof of the analogue of Lemma 5.13, Subcase 2.1 does not arise. Indeed the situation there is that we are considering a partition α of the form $\begin{pmatrix} A_1 & \cdots & A_q & C_1 & \cdots & C_r \\ B_1 & \cdots & B_q & D_1 & \cdots & D_s \end{pmatrix}$. The assumption in Subcase 2.1 is that $i, j \in A_1$ and $i \neq j$. However, if $\alpha \in \mathcal{PB}_n$, then from $|A_1 \cup B_1| \leq 2$ it follows that $|A_1| = |B_1| = 1$.

7 The planar partition monoid \mathcal{PP}_n and the Motzkin monoid \mathcal{M}_n

Recall that the planar partition monoid \mathcal{PP}_n consists of all planar partitions, and that the Motzkin monoid $\mathcal{M}_n = \mathcal{PB}_n \cap \mathcal{PP}_n$ consists of all planar partitions with blocks of sizes ≤ 2 . In this section we describe the congruence lattices of these two monoids. The proof will follow the model set up in Section 5, but the following points should be noted before we begin.

The two congruence lattices $\text{Cong}(\mathcal{PP}_n)$ and $\text{Cong}(\mathcal{M}_n)$ turn out to be isomorphic, in a manner analogous to $\text{Cong}(\mathcal{P}_n)$ and $\text{Cong}(\mathcal{PB}_n)$. We will this time run the two proofs in parallel, concentrating on \mathcal{PP}_n , and making relevant remarks about \mathcal{M}_n when necessary.

Unlike the situation with \mathcal{P}_n and \mathcal{PB}_n , Green’s \mathcal{H} relation on \mathcal{PP}_n is trivial, and hence all subgroups of \mathcal{PP}_n are trivial. This has two consequences. Firstly, the role that was played by the symmetric inverse monoid \mathcal{I}_n will now be played by $\mathcal{I}_n \cap \mathcal{PP}_n = \mathcal{O}_n$, the monoid of order-preserving partial permutations of \mathbf{n} . Thus, in this section, for a congruence $\xi \in \text{Cong}(\mathcal{PP}_n)$ we will write $\bar{\xi} = \xi \cap (\mathcal{O}_n \times \mathcal{O}_n)$ for its

restriction to \mathcal{O}_n . And, secondly, there will be no congruences of the type $R_N, \lambda_N, \rho_N, \mu_N$, for non-trivial normal subgroups N of \mathcal{S}_q .

Yet again, for $q = 0, \dots, n$, we have ideals I_q , \mathcal{J} -classes J_q , and Rees congruences R_q (Definition 3.1). The first main step is to verify that our familiar retraction $f : \alpha \mapsto \hat{\alpha}$ remains valid in the context of \mathcal{PP}_n (see Corollary 7.2). In order to do that, and for later use, it will be convenient to discuss a particular canonical graphical representation of a planar partition $\alpha \in \mathcal{PP}_n$.

Let $A = \{a_1, \dots, a_k\}$ and $B = \{b_1, \dots, b_l\}$ be (possibly equal) nonempty subsets of \mathbf{n} with $a_1 < \dots < a_k$ and $b_1 < \dots < b_l$. We define three graphs $\Gamma_A, \Gamma_{B'}$ and $\Gamma_{A \cup B'}$ as follows. All three graphs have vertex set $\mathbf{n} \cup \mathbf{n}'$, and the edge sets are given by

$$\begin{aligned} E(\Gamma_A) &= \{\{a_1, a_2\}, \dots, \{a_{k-1}, a_k\}\}, & E(\Gamma_{B'}) &= \{\{b'_1, b'_2\}, \dots, \{b'_{l-1}, b'_l\}\}, \\ E(\Gamma_{A \cup B'}) &= E(\Gamma_A) \cup E(\Gamma_{B'}) \cup \{\{a_1, b'_1\}, \{a_k, b'_k\}\}. \end{aligned}$$

If $\alpha \in \mathcal{P}_n$ is an arbitrary partition, we define the *canonical graph of α* to be the graph Γ_α with vertex set $\mathbf{n} \cup \mathbf{n}'$ and edge set $E(\Gamma_\alpha) = \bigcup_{X \in \alpha} E(\Gamma_X)$, where the union is over all blocks X of α . As an example, the canonical graph of $\alpha = \begin{pmatrix} 1, 4 & | & 7 & 2, 3 & | & 5 & 6 & | & 8 \\ 1, 2, 4 & | & 8 & | & 3 & | & 5, 6, 7 \end{pmatrix} \in \mathcal{PP}_8$ is given in Figure 10 below (in black).

Let A, B be nonempty subsets of \mathbf{n} as in the previous paragraph. We say that A and B are *separated* if $a_k < b_1$ or $b_l < a_1$; in these cases, we write $A < B$ or $B < A$, respectively. We say that A is *nested* by B if there exists some $1 \leq i < l$ such that $b_i < a_1$ and $a_k < b_{i+1}$; we say that A and B are *nested* if A is nested by B or vice versa.

Lemma 7.1. *Let $\alpha = \begin{pmatrix} A_1 & | & \dots & | & A_q & | & C_1 & | & \dots & | & C_r \\ B_1 & | & \dots & | & B_q & | & D_1 & | & \dots & | & D_s \end{pmatrix} \in \mathcal{PP}_n$, with $\min(A_1) < \dots < \min(A_q)$. Then*

- (i) $A_1 < \dots < A_q$ and $B_1 < \dots < B_q$,
- (ii) for all $1 \leq i < j \leq r$, C_i and C_j are either nested or separated,
- (iii) for all $1 \leq i < j \leq s$, D_i and D_j are either nested or separated,
- (iv) for all $1 \leq i \leq q$ and $1 \leq j \leq r$, either A_i and C_j are separated or else C_j is nested by A_i ,
- (v) for all $1 \leq i \leq q$ and $1 \leq j \leq s$, either B_i and D_j are separated or else D_j is nested by B_i .

Consequently, the canonical graph Γ_α may be drawn in planar fashion (within the rectangle determined by the vertices).

Proof. Clearly the last assertion follows from items (i)–(v). Since $\alpha \in \mathcal{PP}_n$, it is represented by some planar graph, say Γ . The proofs of (i)–(v) are similar; each is proved by identifying paths in Γ that would cross if the desired conclusion did not hold. We just prove (i), and leave the rest to the reader. Suppose $1 \leq i < q$, and write $a = \min(A_i)$, $b = \max(B_i)$, $c = \min(A_{i+1})$ and $d = \min(B_{i+1})$. In Γ , there is a path π_{ab} from a to b' , and a path π_{cd} from c to d' . By assumption, $a < c$. If $d < b$, then the paths π_{ab} and π_{cd} would have to intersect. Thus, $b < d$: i.e., $B_i < B_{i+1}$, giving the second claim in (i). Since this clearly implies $\min(B_1) < \dots < \min(B_q)$, the rest of the first claim follows upon applying the above argument to $\alpha^* = \begin{pmatrix} B_1 & | & \dots & | & B_q & | & D_1 & | & \dots & | & D_s \\ A_1 & | & \dots & | & A_q & | & C_1 & | & \dots & | & C_r \end{pmatrix}$. \square

For any $\alpha \in \mathcal{PP}_n$, the canonical graph of $\hat{\alpha}$ is obtained from that of α by deleting the transverse edges, so the final assertion of Lemma 7.1 immediately gives the following.

Corollary 7.2. *The map $\alpha \mapsto \hat{\alpha}$ from Definition 5.1 maps \mathcal{PP}_n into \mathcal{PP}_n . \square*

So, as in the case of \mathcal{P}_n , the map $I_1 \rightarrow I_0 : \alpha \mapsto \hat{\alpha}$ is a retraction (and, as with \mathcal{P}_n , no larger ideal of \mathcal{PP}_n is retractable). This time, however, due to the fact that the maximal subgroup corresponding to J_2 is trivial, rather than \mathcal{S}_2 , we only have two retractable IN-pairs: namely, $\mathcal{C}_0 = (I_0, \{\overline{id_1}\})$, $\mathcal{C}_1 = (I_1, \{\overline{id_2}\})$. They give rise to six congruences (Definition 3.18), which we abbreviate to $\lambda_0, \rho_0, \mu_0 (= \Delta), \lambda_1, \rho_1, \mu_1$.

Theorem 7.3. Let $n \geq 2$, and let \mathcal{PP}_n (resp., \mathcal{M}_n) be the planar partition monoid (resp., Motzkin monoid) of degree n , respectively.

- (i) The ideals of \mathcal{PP}_n (resp., \mathcal{M}_n) are the sets I_q , for $q = 0, \dots, n$, yielding the Rees congruences $R_q = R_{I_q}$, as in Definition 3.1.
- (ii) The retractable IN-pairs of \mathcal{PP}_n (resp., \mathcal{M}_n) are $\mathcal{C}_0 = (I_0, \{\overline{\text{id}}_1\})$ and $\mathcal{C}_1 = (I_1, \{\overline{\text{id}}_2\})$, yielding the congruences $\lambda_0, \rho_0, \mu_0, \lambda_1, \rho_1, \mu_1$, respectively, as in Definition 3.18.
- (iii) The above congruences are distinct, and they exhaust all the congruences of \mathcal{PP}_n (resp., \mathcal{M}_n).
- (iv) The $*$ -congruences of \mathcal{PP}_n (resp., \mathcal{M}_n) are the same, but with $\lambda_0, \lambda_1, \rho_0, \rho_1$ excluded.
- (v) The Hasse diagrams of the congruence and $*$ -congruence lattices of \mathcal{PP}_n (resp., \mathcal{M}_n) are shown in Figure 5.

Proof. As in the proof of Theorem 5.4, the listed relations are congruences by Proposition 3.22, and they form the lattice depicted in Figure 4 by Propositions 3.24–3.29. The proof that there are no further congruences is obtained by describing all the principal congruences, and verifying that they are precisely those listed (see Table 2); this is the content of the remainder of this section. The assertions concerning the $*$ -congruences are immediate consequences, exactly as in the proof of Corollary 5.17. \square

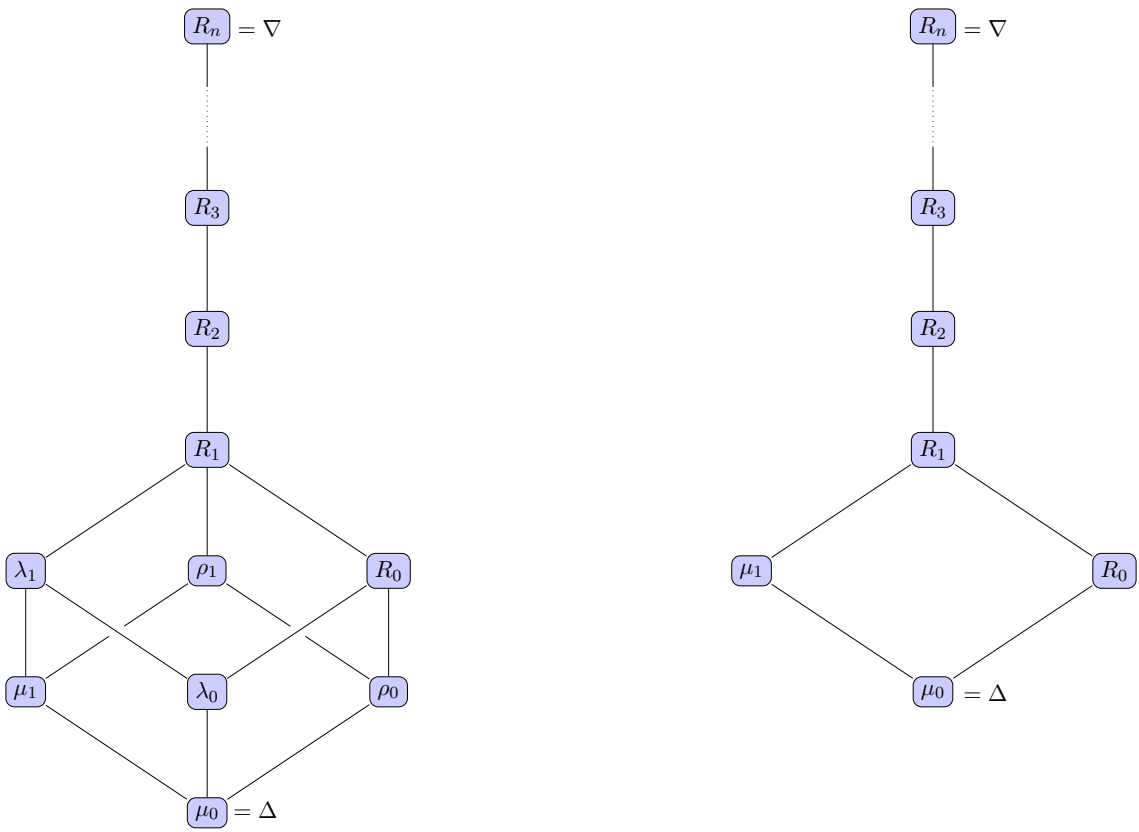

Figure 5: Hasse diagrams of $\text{Cong}(\mathcal{PP}_n)$ and $\text{Cong}(\mathcal{M}_n)$ (left), and of $\text{Cong}^*(\mathcal{PP}_n)$ and $\text{Cong}^*(\mathcal{M}_n)$ (right). All congruences are principal.

We now embark on the task of describing all the principal congruences of \mathcal{PP}_n and \mathcal{M}_n . The proof will be couched in terms of \mathcal{PP}_n ; to obtain a proof for \mathcal{M}_n the reader should check in relevant places that various partitions belong to \mathcal{M}_n (provided that those on which they depend do as well). These checks are trivial, and will not be explicitly indicated. The sequence of lemmas follows a similar pattern as we had in Section 5 (minus the lemmas dealing with the congruences $R_N, \lambda_N, \rho_N, \mu_N$ that no longer exist in our present set-up). We will state all the lemmas, together with the references to their counterparts from Section 5, but we will not rehearse all the proof details; instead we will point at the instances where planarity of partitions plays a role. The references to Liber’s Theorem 4.1 should be replaced by those to Fernandes’ Theorem 4.2.

q	Additional conditions	$(\alpha, \beta)^\sharp$	Reference
	$\alpha = \beta$	Δ	
0	$(\alpha, \beta) \in \mathcal{R} \setminus \Delta$	ρ_0	Proposition 7.5(i)
0	$(\alpha, \beta) \in \mathcal{L} \setminus \Delta$	λ_0	Proposition 7.5(ii)
0	$(\alpha, \beta) \notin \mathcal{L} \cup \mathcal{R}$	R_0	Proposition 7.6(i)
1	$\widehat{\alpha} = \widehat{\beta}, \alpha \neq \beta$	μ_1	Proposition 7.5(iii)
1	$(\widehat{\alpha}, \widehat{\beta}) \in \mathcal{R} \setminus \Delta$	ρ_1	Proposition 7.6(ii)
1	$(\widehat{\alpha}, \widehat{\beta}) \in \mathcal{L} \setminus \Delta$	λ_1	Proposition 7.6(iii)
1	$(\widehat{\alpha}, \widehat{\beta}) \notin \mathcal{L} \cup \mathcal{R}$	R_1	Proposition 7.6(iv)
≥ 2	$\alpha \neq \beta$	R_q	Proposition 7.10

Table 2: The principal congruences $(\alpha, \beta)^\sharp$ on \mathcal{PP}_n , with $q = \text{rank}(\alpha) \geq \text{rank}(\beta)$.

Lemma 7.4 (cf. Lemma 5.7(i)). *Let $\xi \in \text{Cong}(\mathcal{PP}_n)$. If $\overline{R}_1 \subseteq \xi$, then $\mu_1 \subseteq \xi$. Thus, $\mu_1 = \overline{R}_1^\sharp$.*

Proof. To make the proof of Lemma 5.7(i) work here, we observe that, given $\alpha = \left(\begin{array}{c|c|c|c} A_0 & A_1 & \cdots & A_r \\ \hline B_0 & B_1 & \cdots & B_s \end{array} \right) \in \mathcal{PP}_n$, the partitions $\gamma = \left(\begin{array}{c|c|c|c} A_0 & A_1 & \cdots & A_r \\ \hline 1 & 2 & \cdots & n \end{array} \right)$ and $\delta = \left(\begin{array}{c|c|c|c} 1 & 2 & \cdots & n \\ \hline B_0 & B_1 & \cdots & B_s \end{array} \right)$ also belong to \mathcal{PP}_n (as easily follows from Lemma 7.1), as do $\sigma = \left[\begin{array}{c} 1 \\ 1 \end{array} \right]$ and $\tau = [\emptyset]$ trivially. \square

Proposition 7.5 (cf. Proposition 5.8). *The relations ρ_0, λ_0, μ_1 are all principal congruences on \mathcal{PP}_n . Moreover, if $\alpha, \beta \in \mathcal{PP}_n$, then*

$$(i) \rho_0 = (\alpha, \beta)^\sharp \Leftrightarrow (\alpha, \beta) \in \rho_0 \setminus \Delta, \quad (ii) \lambda_0 = (\alpha, \beta)^\sharp \Leftrightarrow (\alpha, \beta) \in \lambda_0 \setminus \Delta, \quad (iii) \mu_1 = (\alpha, \beta)^\sharp \Leftrightarrow (\alpha, \beta) \in \mu_1 \setminus \Delta.$$

Proof. Here we need to deal with the fact that the partition $\tau = \left(\begin{array}{c|c|c|c} i & j & k_1 & \cdots & k_{n-2} \\ \hline m & C & B_2 & \cdots & B_r \end{array} \right)$ constructed during the proof of part (i) of Proposition 5.8 may fail to be planar. However, since σ is itself planar, we can ensure that τ is planar by assuming that $i < j$, and that m is the minimal element of \mathbf{n} such that the coker(σ)-class of m is nontrivial (this also ensures that $m = \min(B_1)$, where B_1 is the coker(σ)-class of m). \square

Proposition 7.6 (cf. Proposition 5.9). *The congruences R_0, ρ_1, λ_1 and R_1 are all principal. Moreover, if $\alpha, \beta \in \mathcal{PP}_n$, then*

$$(i) R_0 = (\alpha, \beta)^\sharp \Leftrightarrow (\alpha, \beta) \in R_0 \setminus (\rho_0 \cup \lambda_0), \quad (iii) \lambda_1 = (\alpha, \beta)^\sharp \Leftrightarrow (\alpha, \beta) \in \lambda_1 \setminus (\mu_1 \cup \lambda_0), \\ (ii) \rho_1 = (\alpha, \beta)^\sharp \Leftrightarrow (\alpha, \beta) \in \rho_1 \setminus (\mu_1 \cup \rho_0), \quad (iv) R_1 = (\alpha, \beta)^\sharp \Leftrightarrow (\alpha, \beta) \in R_1 \setminus (R_0 \cup \lambda_1 \cup \rho_1).$$

Proof. The partition $\delta = \left(\begin{array}{c|c|c|c} k & i, j & j_1 & \cdots & j_{n-3} \\ \hline k & i, j & j_1 & \cdots & j_{n-3} \end{array} \right)$ constructed in the second subcase of case (a) in the proof of Proposition 5.9(ii) is nonplanar if and only if $i < k < j$ or $j < k < i$. However, since (j, k) was an arbitrary pair from $\text{coker}(\alpha) \setminus \text{coker}(\beta)$, we could just reverse the roles of j and k , and so define $\delta = \left(\begin{array}{c|c|c|c} j & i, k & j_1 & \cdots & j_{n-3} \\ \hline j & i, k & j_1 & \cdots & j_{n-3} \end{array} \right)$ if either of the above inequalities hold. \square

Lemma 7.7 (cf. Lemma 5.12). *For every $\alpha \in \mathcal{PP}_n$, there exists $\beta \in \mathcal{O}_n$ with $\text{rank}(\beta) = \text{rank}(\alpha)$, $\alpha = \alpha\beta\alpha$ and $\beta = \beta\alpha\beta$.*

Proof. The planarity of $\beta \in \mathcal{I}_n$, as constructed in the proof of Lemma 5.12, follows from Lemma 7.1(i). \square

Lemma 7.8 (cf. Lemma 5.13). *Let $\alpha, \beta \in J_q$ with $q \geq 1$.*

- (i) *If $(\alpha, \beta) \notin \mathcal{R}$, then there exists $\gamma \in J_q$ such that precisely one of $\gamma\alpha, \gamma\beta$ belongs to J_q .*
- (ii) *If $(\alpha, \beta) \notin \mathcal{L}$, then there exists $\gamma \in J_q$ such that precisely one of $\alpha\gamma, \beta\gamma$ belongs to J_q .*

Proof. The partition $\gamma = \left(\begin{array}{c|c|c|c|c} a_1 & \cdots & a_{q-1} & i & a_q, j & x_3 & \cdots & x_{n-q} \\ a_1 & \cdots & a_{q-1} & i & a_q, j & x_3 & \cdots & x_{n-q} \end{array} \right)$ constructed during Subcase 2.2 of the proof of Lemma 5.13 could be nonplanar. However, in the case that α is planar, we can easily modify the definition of γ to ensure that γ is planar and still fulfils its purpose in the proof. Indeed, first, we assume that $i, j \in C_1$ satisfy $i < j$. We also note that, since α is planar, no element $x \in \text{dom}(\alpha)$ can satisfy $i < x < j$. So, for each $x \in \text{dom}(\alpha)$, we have either $x < i$ or $j < x$. If there are no elements $x \in \text{dom}(\alpha)$ with $x < i$ then, renaming the sets A_1, \dots, A_q if necessary, we may assume that $a_q = \min(\text{dom}(\alpha))$, and we define γ as above. If there is some $x \in \text{dom}(\alpha)$ with $x < i$ then, again renaming if necessary, we may assume that $a_q = \max\{x \in \text{dom}(\alpha) : x < i\}$, and we instead define $\gamma = \left(\begin{array}{c|c|c|c|c} a_1 & \cdots & a_{q-1} & j & a_q, i & x_3 & \cdots & x_{n-q} \\ a_1 & \cdots & a_{q-1} & j & a_q, i & x_3 & \cdots & x_{n-q} \end{array} \right)$. \square

Lemma 7.9 (cf. Lemma 5.15). *If $2 \leq q \leq n$, then $R_q = \overline{R}_q^\sharp$.* \square

Proposition 7.10 (cf. Proposition 5.16). *Let $2 \leq q \leq n$. Then R_q is a principal congruence on \mathcal{PP}_n . Moreover, if $\alpha, \beta \in \mathcal{PP}_n$, then $R_q = (\alpha, \beta)^\sharp \Leftrightarrow (\alpha, \beta) \in R_q \setminus R_{q-1}$.* \square

8 The Brauer monoid \mathcal{B}_n

We now move onto the Brauer monoid \mathcal{B}_n , consisting of all partitions $\alpha \in \mathcal{P}_n$ having all the blocks of size 2. Again, $\text{Cong}(\mathcal{B}_n)$ is easily described for $n \leq 2$, so we will assume $n \geq 3$ for the duration of this section.

There are some differences between \mathcal{B}_n and the preceding monoids that are worth paying attention to. Firstly, there will be a difference in behaviour depending on the parity of n , the reason for which is in the \mathcal{J} -class structure of \mathcal{B}_n . Perhaps most notably, for n even, the basic diamond shapes forming the lower part of $\text{Cong}(\mathcal{B}_n)$ are due to a new retraction. And finally, the symmetric inverse monoid \mathcal{I}_n , which was a linchpin in several parts of the argument of the previous section, does not embed in \mathcal{B}_n (as can be seen by comparing sizes of maximal subgroups in the top two \mathcal{J} -classes of both monoids); consequently, modifications are needed for that aspect of the argument.

The \mathcal{J} -classes of \mathcal{B}_n are J_n, J_{n-2}, \dots, J_z , where $J_q = \{\alpha \in \mathcal{B}_n : \text{rank}(\alpha) = q\}$, and $z \in \{0, 1\}$ satisfies $z \equiv n \pmod{2}$. This meaning of z will be fixed throughout the section. The corresponding ideals are $I_q = J_q \cup \dots \cup J_z$, and they induce Rees congruences R_q . The minimal ideal of \mathcal{B}_n is $J_z = I_z$. As in \mathcal{P}_n , we single out one particular copy of \mathcal{S}_q inside J_q , but the construction is slightly different: for $\sigma \in \mathcal{S}_q$, we let $\bar{\sigma} = \left(\begin{array}{c|c|c|c|c} 1 & \cdots & q & q+1, q+2 & \cdots & n-1, n \\ 1\sigma & \cdots & q\sigma & q+1, q+2 & \cdots & n-1, n \end{array} \right) \in J_q$.

For every $q \in \{z+2, \dots, n\}$ and every normal subgroup N of \mathcal{S}_q we have an IN-pair (I_{q-2}, \overline{N}) , yielding a congruence

$$R_N = R_{q-2} \cup \nu_N = \Delta \cup \nu_N \cup (I_{q-2} \times I_{q-2}),$$

where $\nu_N = \{(\alpha, \beta) \in J_q \times J_q : \alpha \not\sim \beta, \phi(\alpha, \beta) \in N\}$. (Note that the proof of Lemma 5.6 needs to be slightly modified to work for \mathcal{B}_n : namely, the partitions γ, δ defined in the early stages of the proof need to be replaced by $\gamma = \left(\begin{array}{c|c|c|c|c} A_1 & \cdots & A_q & C_1 & \cdots & C_r \\ 1 & \cdots & q & q+1, q+2 & \cdots & n-1, n \end{array} \right)$ and $\delta = \left(\begin{array}{c|c|c|c|c} 1 & \cdots & q & q+1, q+2 & \cdots & n-1, n \\ B_1 & \cdots & B_q & D_1 & \cdots & D_s \end{array} \right)$.) The congruences R_q, R_N form a chain (again, due to the fact that ideals of \mathcal{B}_n and normal subgroups of all \mathcal{S}_q form chains; see Proposition 3.24), and we will see that they account for all the upper congruences, as well as some of the lower congruences.

The remaining lower congruences arise from retractions, which depend on the parity of n . For n odd, we just take the identity retraction $I_1 \rightarrow I_1$ to obtain a retractable IN-pair $(I_1, \{\widehat{\text{id}}_3\})$, which in turn yields three congruences λ_1, ρ_1 and $\mu_1 = \Delta$. However, for n even, we have a new non-trivial retraction!

Definition 8.1. For a Brauer element α of rank 2 with transversals $\{i, j'\}$ and $\{k, l'\}$, let $\widehat{\alpha}$ be the Brauer element of rank 0 obtained by replacing these transversals by the non-transversals $\{i, k\}$ and $\{j', l'\}$. For $\alpha \in \mathcal{B}_n$ with $\text{rank}(\alpha) = 0$, let $\widehat{\alpha} = \alpha$.

We will make no use of the mapping from Definition 5.1 in this section, so there should be no confusion arising from our re-use of the $\widehat{\alpha}$ notation. An example calculation is given in Figure 6.

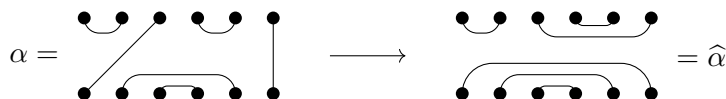

Figure 6: A rank-2 Brauer element $\alpha \in \mathcal{B}_6$ (left), with $\widehat{\alpha} \in \mathcal{B}_6$ (right).

Lemma 8.2. For n even, the map $f : I_2 \rightarrow I_0 : \alpha \mapsto \widehat{\alpha}$ is a retraction.

Proof. We know that $\alpha f = \alpha$ for $\alpha \in I_0$, so we just need to show that $\widehat{\alpha\beta} = \widehat{\alpha}\widehat{\beta}$ for all $\alpha, \beta \in I_2$. If $\alpha, \beta \in I_0$ the assertion is obvious, so assume without loss of generality that $\alpha \in J_2$, and write $\alpha = \begin{pmatrix} a & b & | & A_1 & \cdots & | & A_{m-1} \\ x & y & | & B_1 & \cdots & | & B_{m-1} \end{pmatrix}$. We may also write $\beta = \begin{pmatrix} c & d & | & C_1 & \cdots & | & C_{m-1} \\ u & v & | & D_1 & \cdots & | & D_{m-1} \end{pmatrix}$ or $\begin{pmatrix} c & d & | & C_1 & \cdots & | & C_{m-1} \\ u, v & & | & D_1 & \cdots & | & D_{m-1} \end{pmatrix}$. In either case, we clearly have $\widehat{\alpha\beta} = \begin{pmatrix} a, b & | & A_1 & \cdots & | & A_{m-1} \\ u, v & | & D_1 & \cdots & | & D_{m-1} \end{pmatrix}$. It is also clear that $\alpha\beta = \begin{pmatrix} a & b & | & A_1 & \cdots & | & A_{m-1} \\ u & v & | & D_1 & \cdots & | & D_{m-1} \end{pmatrix}$ or $\begin{pmatrix} a & b & | & A_1 & \cdots & | & A_{m-1} \\ v & u & | & D_1 & \cdots & | & D_{m-1} \end{pmatrix}$ or $\begin{pmatrix} a, b & | & A_1 & \cdots & | & A_{m-1} \\ u, v & | & D_1 & \cdots & | & D_{m-1} \end{pmatrix}$, from which $\widehat{\alpha\beta} = \widehat{\alpha}\widehat{\beta}$ follows. \square

As with \mathcal{P}_n , one may show that no ideals larger than I_1 (n odd) or I_2 (n even) are retractable. When n is odd, we have the obvious retractable IN-pair $\mathcal{C}_1 = (I_1, \{\widehat{\text{id}}_3\})$, but there are several retractable pairs when n is even.

Lemma 8.3. For n even, each of $\mathcal{C}_0 = (I_0, \{\widehat{\text{id}}_2\})$, $\mathcal{C}_{S_2} = (I_0, \overline{S_2})$, $\mathcal{C}_2 = (I_2, \{\widehat{\text{id}}_4\})$, $\mathcal{C}_K = (I_2, \overline{K})$ is a retractable IN-pair, where K denotes the Klein 4-group.

Proof. Having already verified that f is a retraction, we only need to check that $|\alpha\overline{S_2}| = |\overline{S_2}\alpha| = |\alpha\overline{K}| = |\overline{K}\alpha| = 1$ for any $\alpha = \begin{pmatrix} A_1 & A_2 & | & \cdots & | & A_m \\ B_1 & B_2 & | & \cdots & | & B_m \end{pmatrix} \in I_0$.

For the S_2 part of the assertion, it is clearly sufficient to show that $\alpha\overline{\text{id}}_2 = \alpha\overline{(1,2)}$. This follows immediately by noting that both these Brauer elements have upper blocks A_1, \dots, A_m and the lower blocks $\{1, 2\}, \{3, 4\}, \dots, \{n-1, n\}$.

Let us now prove the assertion for K . Clearly, it is sufficient to prove that $\alpha\overline{\text{id}}_4 = \alpha\overline{\gamma}$ for all $\gamma \in K \setminus \{\text{id}_4\}$. The upper blocks of $\alpha\overline{\text{id}}_4$ are A_1, \dots, A_m . The lower blocks are $\{5, 6\}, \dots, \{n-1, n\}$, and two blocks partitioning $\{1, 2, 3, 4\}$. Without loss we may assume that these last two blocks are in fact $\{1, 2\}$ and $\{3, 4\}$. This means that in the product graph $\Pi(\alpha, \overline{\text{id}}_4)$ there is a path from $1'$ to $2'$ and a path from $3'$ to $4'$. But this is equivalent to saying that there is a path π_{12} from $1''$ to $2''$, and a path π_{34} from $3''$ to $4''$. Now consider the Brauer element $\alpha\overline{\gamma}$. Its upper blocks are also A_1, \dots, A_m , and the lower blocks include $\{5, 6\}, \dots, \{n-1, n\}$. Notice that the paths π_{12} and π_{34} are also present in the product graph $\Pi(\alpha, \overline{\gamma})$, as they involve only vertices from \mathbf{n}'' .

Consider the case in which $\gamma = (1, 2)(3, 4)$. Then concatenating the edge $2' \rightarrow 1''$ with the path π_{12} and the edge $2'' \rightarrow 1'$ yields a path from $2'$ to $1'$ in $\Pi(\alpha, \overline{\gamma})$. It follows that $\{1, 2\}$ and $\{3, 4\}$ are lower blocks of $\alpha\overline{\gamma}$, and hence $\alpha\overline{\gamma} = \alpha\overline{\text{id}}_4$. The cases in which $\gamma = (1, 3)(2, 4)$ or $(1, 4)(2, 3)$ are analogous. \square

We denote the congruences arising from these pairs $\lambda_0, \rho_0, \mu_0, \lambda_{S_2}, \rho_{S_2}, \mu_{S_2}, \lambda_2, \rho_2, \mu_2, \lambda_K, \rho_K, \mu_K$, respectively.

Theorem 8.4. Let $n \geq 3$, and let \mathcal{B}_n be the Brauer monoid of degree n . Also let $z \in \{0, 1\}$ be such that $n \equiv z \pmod{2}$.

- (i) The ideals of \mathcal{B}_n are the sets I_q , for $q = z, z+2, \dots, n$, yielding the Rees congruences $R_q = R_{I_q}$, as in Definition 3.1.
- (ii) The proper IN-pairs of \mathcal{B}_n are of the form (I_{q-2}, \overline{N}) , for $q = z+2, z+4, \dots, n$ and for any non-trivial normal subgroup N of S_q , yielding the congruences $R_N = R_{I_{q-2}, \overline{N}}$, as in Definition 3.16.
- (iii) For n odd, the only retractable IN-pair of \mathcal{B}_n is $\mathcal{C}_1 = (I_1, \{\widehat{\text{id}}_3\})$, yielding the congruences λ_1, ρ_1, μ_1 , as in Definition 3.18.
- (iv) For n even, the retractable IN-pairs of \mathcal{B}_n are $\mathcal{C}_0 = (I_0, \{\widehat{\text{id}}_2\})$, $\mathcal{C}_{S_2} = (I_0, \overline{S_2})$, $\mathcal{C}_2 = (I_2, \{\widehat{\text{id}}_4\})$ and $\mathcal{C}_K = (I_2, \overline{K})$, yielding the congruences $\lambda_0, \rho_0, \mu_0, \lambda_{S_2}, \rho_{S_2}, \mu_{S_2}, \lambda_2, \rho_2, \mu_2, \lambda_K, \rho_K, \mu_K$, respectively, as in Definition 3.18. Here, K denotes the Klein 4-group.
- (v) The above congruences are distinct, and they exhaust all the congruences of \mathcal{B}_n .
- (vi) The Hasse diagram of the congruence lattice $\text{Cong}(\mathcal{B}_n)$ is shown in Figure 7.
- (vii) The $*$ -congruences of \mathcal{B}_n are the same, but with λ_1, ρ_1 (n odd) or $\lambda_0, \lambda_{S_2}, \lambda_2, \lambda_K, \rho_0, \rho_{S_2}, \rho_2, \rho_K$ (n even) excluded.

Proof. The overall structure of the proof is the same as that of Theorem 5.4. That all the listed relations are congruences follows from Proposition 3.22, and that they form sublattices of $\text{Cong}(\mathcal{B}_n)$ as shown in Figure 7 follows from Propositions 3.24–3.29. It remains to be proved that there are no other congruences, which can be done by showing that all the principal congruences are among the listed ones. The principal congruences are shaded blue in Figure 7, and we prove that they are principal in the remainder of the section, characterising their minimal generating sets. Again, the proof is completed by observing that this covers all possible pairs; see Table 3. \square

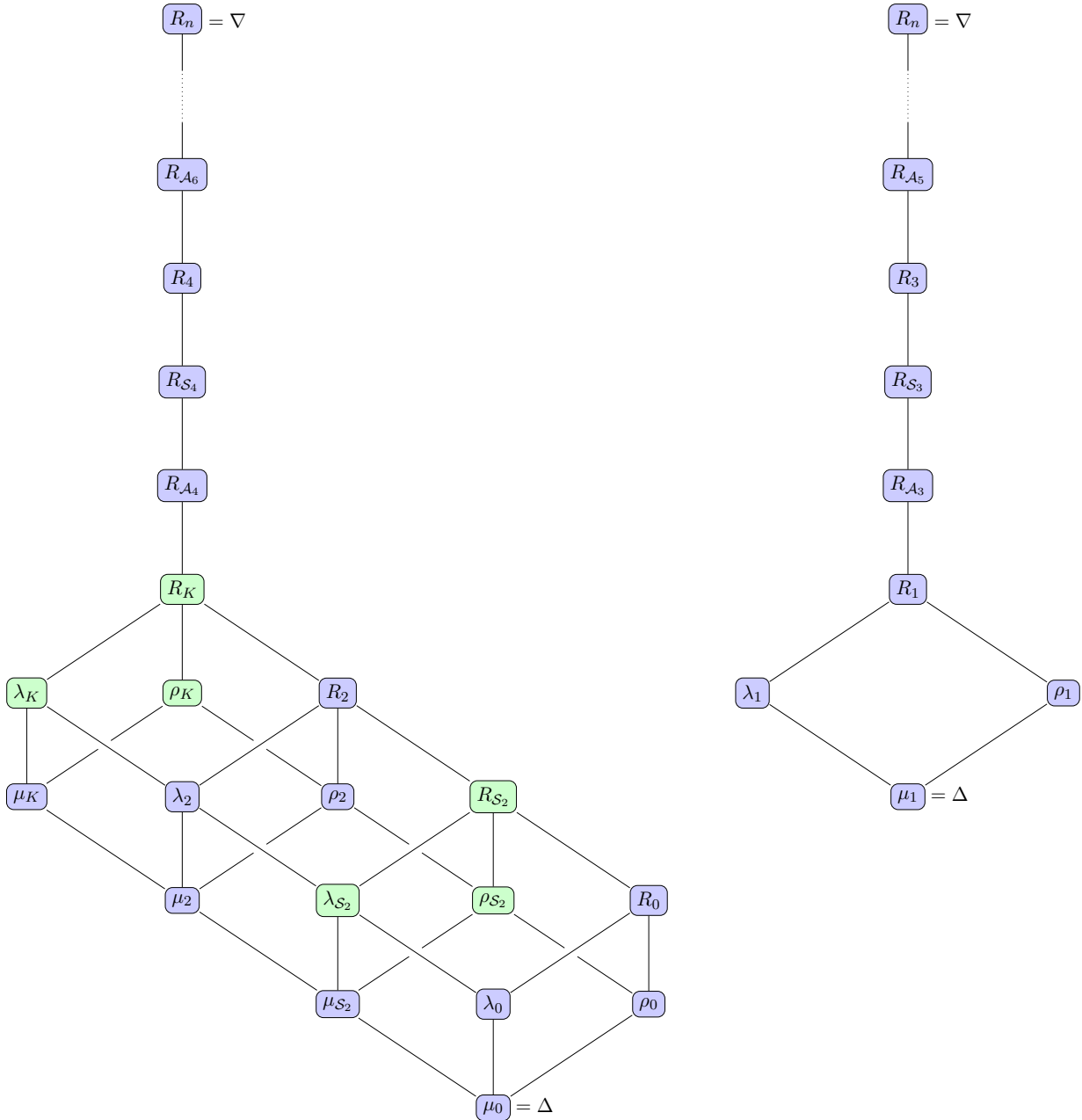

Figure 7: Hasse diagram for the congruence lattice $\text{Cong}(\mathcal{B}_n)$ in the case of n even (left) and n odd (right). Congruences shaded blue are principal; those shaded green are minimally generated by two pairs of Brauer elements.

q	Additional conditions	$(\alpha, \beta)^\sharp$	Reference
	$\alpha = \beta$	Δ	
z	$(\alpha, \beta) \in \mathcal{R} \setminus \Delta$	ρ_z	Proposition 8.5(i)
z	$(\alpha, \beta) \in \mathcal{L} \setminus \Delta$	λ_z	Proposition 8.5(ii)
z	$(\alpha, \beta) \notin \mathcal{L} \cup \mathcal{R}$	R_z	Proposition 8.6
2	$(\alpha, \beta) \in \mathcal{H} \setminus \Delta$	$\mu_{\mathcal{S}_2}$	Proposition 8.7(i)
2	$\widehat{\alpha} = \widehat{\beta}, (\alpha, \beta) \notin \mathcal{H}$	μ_2	Proposition 8.7(ii)
2	$(\widehat{\alpha}, \widehat{\beta}) \in \mathcal{R} \setminus \Delta$	ρ_2	Proposition 8.8(i)
2	$(\widehat{\alpha}, \widehat{\beta}) \in \mathcal{L} \setminus \Delta$	λ_2	Proposition 8.8(ii)
2	$(\widehat{\alpha}, \widehat{\beta}) \notin \mathcal{L} \cup \mathcal{R}$	R_2	Proposition 8.8(iii)
4	$(\alpha, \beta) \in \mathcal{H} \setminus \Delta, \phi(\alpha, \beta) \in K$	μ_K	Proposition 8.7(iii)
≥ 3	$(\alpha, \beta) \notin \mathcal{H}$	R_q	Proposition 8.17
≥ 3	$(\alpha, \beta) \in \mathcal{H} \setminus \Delta, \phi(\alpha, \beta) \notin K$	R_N	Proposition 8.17

Table 3: The principal congruences $(\alpha, \beta)^\sharp$ on \mathcal{B}_n , with $q = \text{rank}(\alpha) \geq \text{rank}(\beta)$. Here, K is the Klein 4-group. In the last row, N stands for the normal closure in \mathcal{S}_q of $\phi(\alpha, \beta)$.

As was the case with \mathcal{P}_n , it will be convenient to give explicit criteria for membership in each of the lower congruences on \mathcal{B}_n . For arbitrary n :

- $\rho_z = \Delta \cup \{(\alpha, \beta) \in I_z \times I_z : \ker(\alpha) = \ker(\beta)\},$
- $\lambda_z = \Delta \cup \{(\alpha, \beta) \in I_z \times I_z : \text{coker}(\alpha) = \text{coker}(\beta)\},$

and for even n :

- $\rho_{\mathcal{S}_2} = \rho_0 \cup (\mathcal{H} \cap (J_2 \times J_2)),$
- $\lambda_{\mathcal{S}_2} = \lambda_0 \cup (\mathcal{H} \cap (J_2 \times J_2)),$
- $\mu_{\mathcal{S}_2} = \Delta \cup (\mathcal{H} \cap (J_2 \times J_2)),$
- $\rho_2 = \Delta \cup \{(\alpha, \beta) \in I_2 \times I_2 : \ker(\widehat{\alpha}) = \ker(\widehat{\beta})\},$
- $\lambda_2 = \Delta \cup \{(\alpha, \beta) \in I_2 \times I_2 : \text{coker}(\widehat{\alpha}) = \text{coker}(\widehat{\beta})\},$
- $\mu_2 = \Delta \cup \{(\alpha, \beta) \in I_2 \times I_2 : \widehat{\alpha} = \widehat{\beta}\},$
- $\rho_K = \rho_2 \cup \nu_K,$
- $\lambda_K = \lambda_2 \cup \nu_K,$
- $\mu_K = \mu_2 \cup \nu_K,$

where $\nu_K = \{(\alpha, \beta) \in J_4 \times J_4 : \alpha \mathcal{H} \beta, \phi(\alpha, \beta) \in K\}$.

We now embark on the task of describing the generating pairs for the principal congruences indicated in Figure 7. We begin with the lower congruences, where the arguments, of necessity, will depend on the parity of n . First we offer a unified treatment of the congruences λ_z, ρ_z, R_z . A *2-partition* of a set is a partition of the set in which each block has size 2.

Proposition 8.5. *The relations ρ_z and λ_z are principal congruences on \mathcal{B}_n . Moreover, if $\alpha, \beta \in \mathcal{B}_n$, then*

- (i) $\rho_z = (\alpha, \beta)^\sharp \Leftrightarrow (\alpha, \beta) \in \rho_z \setminus \Delta,$
- (ii) $\lambda_z = (\alpha, \beta)^\sharp \Leftrightarrow (\alpha, \beta) \in \lambda_z \setminus \Delta.$

Proof. By duality, it suffices to prove (i). Note that $(\alpha, \beta)^\sharp \neq \rho_z$ if $(\alpha, \beta) \notin \rho_z$ or if $(\alpha, \beta) \in \Delta$. Conversely, fix some $(\alpha, \beta) \in \rho_z \setminus \Delta$ and, for simplicity, write $\xi = (\alpha, \beta)^\sharp$. For an integer i , write $H_i = \{2i - 1, 2i\}$. For $\sigma \in J_z$ we write σ' for the unique element of \mathcal{B}_n with $\ker(\sigma') = \ker(\sigma)$ and $H_1, H_2, \dots, H_{\lfloor n/2 \rfloor}$ all being $\text{coker}(\sigma')$ -classes, noting that this forces $\text{codom}(\sigma') = \{n\}$ in the case that n is odd. We claim that $\sigma \xi \sigma'$ for all $\sigma \in J_z$. Once we prove the claim, part (i) of the lemma will follow: indeed, for any two $(\gamma, \delta) \in \rho_z$ we will have $\gamma \xi \gamma' = \delta' \xi \delta$. To prove the claim we consider the even and odd cases separately.

Case 1. Suppose first that $n = 2m$ is even, and write $\sigma = \begin{pmatrix} A_1 & \cdots & A_m \\ B_1 & \cdots & B_m \end{pmatrix}$, where $\min(B_1) < \cdots < \min(B_m)$. Define $h(\sigma) = m$ if $\sigma = \sigma'$ or else $h(\sigma) = \min\{i \in \mathbf{m} : B_i \neq H_i\}$. We proceed by descending induction

on $h(\sigma)$. If $h(\sigma) = m$, then there is nothing to show, since $\sigma = \sigma'$, so suppose $h(\sigma) < m$. Clearly it suffices to show that $\sigma \xi \pi$ for some $\pi \in \mathcal{B}_n$ with $\ker(\pi) = \ker(\sigma)$ and $h(\pi) > h(\sigma)$. Write $k = h(\sigma)$. Then $B_i = H_i$ for each $1 \leq i \leq k-1$, but $B_k \neq H_k$. By the assumption on the values of $\min(B_i)$, it follows that $B_k = \{2k-1, a\}$ and $B_{k+1} = \{2k, b\}$ for some $a, b \geq 2k+1$. Since $\text{coker}(\alpha) \neq \text{coker}(\beta)$, we may fix some $\text{coker}(\alpha)$ -class $\{x, y\}$ that is not a $\text{coker}(\beta)$ -class. Since $\text{rank}(\beta) = 0$, it follows that β has cokernel-classes $\{x, u\}$ and $\{y, v\}$ for some u, v . Fix an arbitrary 2-partition $\{C_1, \dots, C_{m-2}\}$ of $\mathbf{n} \setminus \{u, v, x, y\}$, and define

$$\tau = \left(\begin{array}{c|c|c|c|c} x & y & u & v & \\ \hline 2k-1 & 2k & a & b & \\ \hline B_1 & \cdots & B_{k-1} & B_{k+2} & \cdots \\ \hline & & & & C_{m-2} \\ \hline & & & & B_m \end{array} \right).$$

Then $\sigma = \sigma\beta\tau \xi \sigma\alpha\tau$, and $h(\sigma\alpha\tau) > k$, so the proof of the claim is complete in this case.

Case 2. Now suppose $n = 2m + 1$. Write $\sigma = \left(\begin{array}{c|c|c|c} a & A_1 & \cdots & A_m \\ \hline b & B_1 & \cdots & B_m \end{array} \right)$. We first prove the sub-claim that $\sigma \xi \pi$ for some $\pi \in \mathcal{B}_n$ with $\ker(\pi) = \ker(\sigma)$ and $\text{codom}(\pi) = n$. Indeed, if $b = n$, then there is nothing to prove, so suppose $b \neq n$. Without loss of generality, we may assume that $n \in B_1$, and we may write $B_1 = \{w, n\}$. We will prove that $\sigma \xi \pi$, where $\pi = \left(\begin{array}{c|c|c|c} a & A_1 & A_2 & \cdots & A_m \\ \hline n & b, w & B_2 & \cdots & B_m \end{array} \right)$. To do this, we will define a Brauer element $\tau \in \mathcal{B}_n$ such that $\sigma\alpha\tau = \sigma$ and $\sigma\beta\tau = \pi$. Let the transversals of α and β be $\{c, d'\}$ and $\{c, e'\}$, respectively; note that $\text{dom}(\alpha) = \text{dom}(\beta)$ because $\ker(\alpha) = \ker(\beta)$. If $d \neq e$, then we fix any $w \in \mathbf{n} \setminus \{d, e\}$, and any 2-partition $\{D_1, \dots, D_{m-1}\}$ of $\mathbf{n} \setminus \{d, e, w\}$, and define $\tau = \left(\begin{array}{c|c|c|c} d & w & e & D_1 & \cdots & D_{m-1} \\ \hline b & w & n & B_2 & \cdots & B_m \end{array} \right)$. The reader may check that τ has the desired properties. Now suppose $d = e$. Because $(\alpha, \beta) \in \rho_1 \setminus \Delta$, we may choose some $\text{coker}(\alpha)$ -class $\{x, y\}$ that is not a $\text{coker}(\beta)$ -class. Then β has cokernel-classes $\{x, u\}$ and $\{y, v\}$ for some u, v . Fix an arbitrary 2-partition $\{E_1, \dots, E_{m-1}\}$ of $\mathbf{n} \setminus \{u, x, y\}$, and define $\tau = \left(\begin{array}{c|c|c|c} u & x & y & E_1 & \cdots & E_{m-1} \\ \hline b & w & n & B_2 & \cdots & B_m \end{array} \right)$. Again, the reader may check that τ has the desired properties. This completes the proof of the sub-claim. If $n = 3$, then $\pi = \sigma'$, so the claim is established in this case. For the rest of the proof, we assume that $n \geq 5$.

In view of the sub-claim, we may suppose without loss of generality that $b = n$, so that $\sigma = \left(\begin{array}{c|c|c|c} a & A_1 & \cdots & A_m \\ \hline n & B_1 & \cdots & B_m \end{array} \right)$. Write $\tau_1 = \left(\begin{array}{c|c|c|c} n & H_1 & \cdots & H_m \\ \hline n & B_1 & \cdots & B_m \end{array} \right)$ and $\tau_2 = \left(\begin{array}{c|c|c|c} n & H_1 & \cdots & H_m \\ \hline n & H_1 & \cdots & H_m \end{array} \right)$. Since $\sigma = \sigma\tau_1$ and $\sigma' = \sigma\tau_2$, the proof will be complete if we can show that $\tau_1 \xi \tau_2$. To do this, we first define

$$\sigma_1 = \left(\begin{array}{c|c|c|c} n & H_1 & \cdots & H_{m-1} & H_m \\ \hline n-2 & H_1 & \cdots & H_{m-1} & n-1, n \end{array} \right) \quad \text{and} \quad \sigma_2 = \left(\begin{array}{c|c|c|c} n & H_1 & \cdots & H_{m-2} & H_{m-1} & H_m \\ \hline n & H_1 & \cdots & H_{m-2} & n-4, n-1 & n-3, n-2 \end{array} \right).$$

Note that the proof of the sub-claim above gives $\sigma_1 \xi \tau_2$. Now define

$$\gamma_1 = \left(\begin{array}{c|c|c|c} n-2 & n-1 & n & H_1 & \cdots & H_{m-2} & H_{m-1} \\ \hline n-4 & n-3 & n-2 & H_1 & \cdots & H_{m-2} & n-1, n \end{array} \right) \quad \text{and} \quad \gamma_2 = \left(\begin{array}{c|c|c|c} n-2 & n-1 & n & H_1 & \cdots & H_{m-2} & H_{m-1} \\ \hline n-4 & n-1 & n & H_1 & \cdots & H_{m-2} & n-3, n-2 \end{array} \right).$$

One may then check that $\tau_2 \xi \sigma_1 = \tau_2\gamma_1 \xi \sigma_1\gamma_1 = \sigma_1\gamma_2 \xi \tau_2\gamma_2 = \sigma_2$. In particular, $(\sigma_2, \tau_2)^\sharp \subseteq \xi = (\alpha, \beta)^\sharp$. Now let σ_3, τ_3 be the elements of \mathcal{B}_{n-1} obtained by removing the block $\{n, n'\}$ from $\sigma_2, \tau_2 \in \mathcal{B}_n$, respectively. Write $\zeta = (\sigma_3, \tau_3)^\sharp_{\mathcal{B}_{n-1}}$ for the congruence on \mathcal{B}_{n-1} generated by (σ_3, τ_3) . Since $\sigma_3 \neq \tau_3$, yet σ_3 and τ_3 are related under the ρ_0 -congruence on \mathcal{B}_{n-1} , and since $n-1 \geq 4$ is even, it follows from Case 1 that $\zeta = \rho_0$ (on \mathcal{B}_{n-1}). Consequently, we have $\left(\begin{array}{c|c|c|c} H_1 & \cdots & H_m \\ \hline B_1 & \cdots & B_m \end{array} \right) \zeta \left(\begin{array}{c|c|c|c} H_1 & \cdots & H_m \\ \hline H_1 & \cdots & H_m \end{array} \right)$, and it follows that $\tau_1 \xi \tau_2$, as required. \square

Now that we have described the generating pairs for ρ_z and λ_z , we may easily do the same for their join R_z .

Proposition 8.6. *The congruence R_z is principal. Moreover, if $\alpha, \beta \in \mathcal{B}_n$, then*

$$R_z = (\alpha, \beta)^\sharp \Leftrightarrow (\alpha, \beta) \in R_z \setminus (\rho_z \cup \lambda_z).$$

Proof. For simplicity, we omit the subscript z throughout. The ‘‘only if’’ part is immediate from $R = \rho \vee \lambda$. For the ‘‘if’’ part, let $(\alpha, \beta) \in R \setminus (\rho \cup \lambda)$, noting that clearly $(\alpha, \beta)^\sharp \subseteq R$. Then $\ker(\alpha) = \ker(\alpha\beta)$ and $\text{coker}(\alpha) \neq \text{coker}(\beta) = \text{coker}(\alpha\beta)$, since $\text{rank}(\alpha) = \text{rank}(\beta) = z$ and $(\alpha, \beta) \notin \lambda$. So $(\alpha, \alpha\beta) \in \rho \setminus \Delta$. It follows from Proposition 8.5(i) that $\rho = (\alpha, \alpha\beta)^\sharp = (\alpha\alpha, \alpha\beta)^\sharp \subseteq (\alpha, \beta)^\sharp$. A symmetrical argument shows that $\lambda \subseteq (\alpha, \beta)^\sharp$. It follows that $R = \rho \vee \lambda \subseteq (\alpha, \beta)^\sharp$. \square

The remaining considerations of the lower congruences apply only to the case when n is even. Next we consider the three non-trivial μ congruences coming from the pairs \mathcal{C}_{S_2} , \mathcal{C}_2 and \mathcal{C}_K .

Proposition 8.7. *Let $n = 2m \geq 4$ be even. The relations μ_{S_2}, μ_2, μ_K are all principal congruences on \mathcal{B}_n . Moreover, if $\alpha, \beta \in \mathcal{B}_n$, then*

- (i) $\mu_{S_2} = (\alpha, \beta)^\sharp \Leftrightarrow (\alpha, \beta) \in \mu_{S_2} \setminus \Delta$, (iii) $\mu_K = (\alpha, \beta)^\sharp \Leftrightarrow (\alpha, \beta) \in \mu_K \setminus \mu_2$.
(ii) $\mu_2 = (\alpha, \beta)^\sharp \Leftrightarrow (\alpha, \beta) \in \mu_2 \setminus \mu_{S_2}$,

Proof. The only non-obvious part is the direct inclusion (\subseteq) in the “if” statement in each part. We begin with (i). Let $(\alpha, \beta) \in \mu_{S_2} \setminus \Delta$ be arbitrary. Since $\text{rank}(\alpha) = \text{rank}(\beta) = 2$ and $\alpha \not\mathcal{H} \beta$, yet $\alpha \neq \beta$, we may write $\alpha = \left(\begin{array}{c|c|c|c} a_1 & a_2 & A_1 & \cdots & A_{m-1} \\ b_1 & b_2 & B_1 & \cdots & B_{m-1} \end{array} \right)$ and $\beta = \left(\begin{array}{c|c|c|c} a_1 & a_2 & A_1 & \cdots & A_{m-1} \\ b_2 & b_1 & B_1 & \cdots & B_{m-1} \end{array} \right)$. Now let $(\gamma, \delta) \in \mu_{S_2}$. We must show that $(\gamma, \delta) \in (\alpha, \beta)^\sharp$. If $\gamma = \delta$ there is nothing to prove, so suppose otherwise, and write $\gamma = \left(\begin{array}{c|c|c|c} c_1 & c_2 & C_1 & \cdots & C_{m-1} \\ d_1 & d_2 & D_1 & \cdots & D_{m-1} \end{array} \right)$ and $\delta = \left(\begin{array}{c|c|c|c} c_1 & c_2 & C_1 & \cdots & C_{m-1} \\ d_2 & d_1 & D_1 & \cdots & D_{m-1} \end{array} \right)$. Put $\sigma = \left(\begin{array}{c|c|c|c} c_1 & c_2 & C_1 & \cdots & C_{m-1} \\ a_1 & a_2 & A_1 & \cdots & A_{m-1} \end{array} \right)$ and $\tau = \left(\begin{array}{c|c|c|c} b_1 & b_2 & B_1 & \cdots & B_{m-1} \\ d_1 & d_2 & D_1 & \cdots & D_{m-1} \end{array} \right)$. Then $(\gamma, \delta) = (\sigma\alpha\tau, \sigma\beta\tau) \in (\alpha, \beta)^\sharp$.

For (ii), let $(\alpha, \beta) \in \mu_2 \setminus \mu_{S_2}$ be arbitrary. To simplify the notation, write $\xi = (\alpha, \beta)^\sharp$. There are two possibilities: consulting the definitions of μ_2 and μ_{S_2} , and renaming α, β if necessary, either

- (a) $\text{rank}(\alpha) = 2, \text{rank}(\beta) = 0$ and $\hat{\alpha} = \beta$, or (b) $\text{rank}(\alpha) = \text{rank}(\beta) = 2, \hat{\alpha} = \hat{\beta}$ and $(\alpha, \beta) \notin \mathcal{H}$.

Suppose first that we are in case (a), and write $\alpha = \left(\begin{array}{c|c|c|c} a & b & A_1 & \cdots & A_{m-1} \\ x & y & B_1 & \cdots & B_{m-1} \end{array} \right)$ and $\beta = \left(\begin{array}{c|c|c|c} a & b & A_1 & \cdots & A_{m-1} \\ x & y & B_1 & \cdots & B_{m-1} \end{array} \right)$. We first claim that if $\tau \in \mathcal{B}_n$ is such that $\text{rank}(\tau) \leq 2$, then $(\tau, \hat{\tau}) \in \xi$. Indeed, this is trivial if $\text{rank}(\tau) = 0$, since then $\hat{\tau} = \tau$. So suppose $\text{rank}(\tau) = 2$, and write $\tau = \left(\begin{array}{c|c|c|c} c & d & C_1 & \cdots & C_{m-1} \\ u & v & D_1 & \cdots & D_{m-1} \end{array} \right)$, so that $\hat{\tau} = \left(\begin{array}{c|c|c|c} c & d & C_1 & \cdots & C_{m-1} \\ u & v & D_1 & \cdots & D_{m-1} \end{array} \right)$. We then define $\sigma_1 = \left(\begin{array}{c|c|c|c} c & d & C_1 & \cdots & C_{m-1} \\ a & b & A_1 & \cdots & A_{m-1} \end{array} \right)$ and $\sigma_2 = \left(\begin{array}{c|c|c|c} x & y & B_1 & \cdots & B_{m-1} \\ u & v & D_1 & \cdots & D_{m-1} \end{array} \right)$, and note that $\tau = \sigma_1\alpha\sigma_2 \xi \sigma_1\beta\sigma_2 = \hat{\tau}$, completing the proof of the claim. Now, for arbitrary $(\gamma, \delta) \in \mu_2$, if $\gamma = \delta$ then clearly $(\gamma, \delta) \in \xi$, while if $\gamma \neq \delta$, then $\text{rank}(\gamma), \text{rank}(\delta) \leq 2$ and $\hat{\gamma} = \hat{\delta}$, so that $\gamma \xi \hat{\gamma} = \hat{\delta} \xi \delta$, as required.

Now suppose we are in case (b). Write $\hat{\alpha} = \hat{\beta} = \left(\begin{array}{c|c|c|c} A_1 & \cdots & A_m \\ B_1 & \cdots & B_m \end{array} \right)$, and let $A_1 = \{a, b\}$, $A_m = \{c, d\}$, $B_1 = \{x, y\}$ and $B_m = \{u, v\}$. Without loss of generality, we may assume that $\alpha = \left(\begin{array}{c|c|c|c} a & b & A_2 & \cdots & A_m \\ x & y & B_2 & \cdots & B_m \end{array} \right)$. Since $\text{rank}(\beta) = 2, \hat{\alpha} = \hat{\beta}$, yet $(\alpha, \beta) \notin \mathcal{H}$, there are three possibilities: renaming c, d, u, v if necessary, either

- (c) $\beta = \left(\begin{array}{c|c|c|c} a & b & A_2 & \cdots & A_m \\ u & v & B_1 & \cdots & B_{m-1} \end{array} \right)$, (d) $\beta = \left(\begin{array}{c|c|c|c} c & d & A_1 & \cdots & A_{m-1} \\ x & y & B_2 & \cdots & B_m \end{array} \right)$, or (e) $\beta = \left(\begin{array}{c|c|c|c} c & d & A_1 & \cdots & A_{m-1} \\ u & v & B_1 & \cdots & B_{m-1} \end{array} \right)$.

In all cases, put $\sigma_3 = \left(\begin{array}{c|c|c|c} a & b & A_2 & \cdots & A_m \\ a & b & A_2 & \cdots & A_m \end{array} \right)$ and $\sigma_4 = \left(\begin{array}{c|c|c|c} x & y & B_2 & \cdots & B_m \\ x & y & B_2 & \cdots & B_m \end{array} \right)$. Then

$$\alpha = \sigma_3\alpha = \alpha\sigma_4 \quad \text{and} \quad \hat{\alpha} = \begin{cases} \sigma_3\beta & \text{in cases (d) and (e)} \\ \beta\sigma_4 & \text{in cases (c) and (e)}. \end{cases}$$

In all cases, it follows that $(\alpha, \hat{\alpha}) \in \xi$. Case (a) then gives $\mu_2 \subseteq (\alpha, \hat{\alpha})^\sharp \subseteq \xi$.

Finally, for (iii), let $(\alpha, \beta) \in \mu_K \setminus \mu_2$ and write $\xi = (\alpha, \beta)^\sharp$. Since $(\alpha, \beta) \notin \mu_2$, it follows that $\text{rank}(\alpha) = \text{rank}(\beta) = 4$, $\alpha \not\mathcal{H} \beta$ and $\phi(\alpha, \beta) \in K \setminus \{\text{id}_4\}$. We may therefore write $\alpha = \left(\begin{array}{c|c|c|c|c} a_1 & a_2 & a_3 & a_4 & A_1 & \cdots & A_{m-2} \\ b_1 & b_2 & b_3 & b_4 & B_1 & \cdots & B_{m-2} \end{array} \right)$ and $\beta = \left(\begin{array}{c|c|c|c|c} a_1 & a_2 & a_3 & a_4 & A_1 & \cdots & A_{m-2} \\ b_2 & b_1 & b_4 & b_3 & B_1 & \cdots & B_{m-2} \end{array} \right)$. Define $\sigma_1 = \left(\begin{array}{c|c|c|c|c} a_1 & a_4 & a_2, a_3 & A_1 & \cdots & A_{m-2} \\ a_1 & a_4 & a_2, a_3 & A_1 & \cdots & A_{m-2} \end{array} \right)$. Then $(\sigma_1\alpha, \sigma_1\beta) \in \mu_2 \setminus \mu_{S_2}$, so part (ii) gives $\mu_2 = (\sigma_1\alpha, \sigma_1\beta)^\sharp \subseteq \xi$. It remains to show that $\mu_K \setminus \mu_2 \subseteq \xi$, so let $(\gamma, \delta) \in \mu_K \setminus \mu_2$ be arbitrary. As above, we may write $\gamma = \left(\begin{array}{c|c|c|c|c} c_1 & c_2 & c_3 & c_4 & C_1 & \cdots & C_{m-2} \\ d_1 & d_2 & d_3 & d_4 & D_1 & \cdots & D_{m-2} \end{array} \right)$ and $\delta = \left(\begin{array}{c|c|c|c|c} c_1 & c_2 & c_3 & c_4 & C_1 & \cdots & C_{m-2} \\ d_2 & d_1 & d_4 & d_3 & D_1 & \cdots & D_{m-2} \end{array} \right)$. Define $\sigma_2 = \left(\begin{array}{c|c|c|c|c} c_1 & c_2 & c_3 & c_4 & C_1 & \cdots & C_{m-2} \\ a_1 & a_2 & a_3 & a_4 & A_1 & \cdots & A_{m-2} \end{array} \right)$ and $\sigma_3 = \left(\begin{array}{c|c|c|c|c} b_1 & b_2 & b_3 & b_4 & B_1 & \cdots & B_{m-2} \\ d_1 & d_2 & d_3 & d_4 & D_1 & \cdots & D_{m-2} \end{array} \right)$. Then $(\gamma, \delta) = (\sigma_2\alpha\sigma_3, \sigma_2\beta\sigma_3) \in \xi$, as required. \square

The remaining principal lower congruences are the λ, ρ, R congruences arising from the pair \mathcal{C}_2 .

Proposition 8.8. *Let $n = 2m \geq 4$ be even. The congruences ρ_2 , λ_2 and R_2 are all principal. Moreover, if $\alpha, \beta \in \mathcal{B}_n$, then*

- (i) $\rho_2 = (\alpha, \beta)^\# \Leftrightarrow (\alpha, \beta) \in \rho_2 \setminus (\mu_2 \cup \rho_{\mathcal{S}_2})$, (iii) $R_2 = (\alpha, \beta)^\# \Leftrightarrow (\alpha, \beta) \in R_2 \setminus (\lambda_2 \cup \rho_2 \cup R_{\mathcal{S}_2})$.
(ii) $\lambda_2 = (\alpha, \beta)^\# \Leftrightarrow (\alpha, \beta) \in \lambda_2 \setminus (\mu_2 \cup \lambda_{\mathcal{S}_2})$,

Proof. Again, it suffices prove to the direct inclusion (\subseteq) in the “if” statement in each case. For (i), fix some $(\alpha, \beta) \in \rho_2 \setminus (\mu_2 \cup \rho_{\mathcal{S}_2})$, and write $\xi = (\alpha, \beta)^\#$. Recalling the definitions of ρ_2 , μ_2 and $\rho_{\mathcal{S}_2}$, we may assume (renaming α, β if necessary) that $\text{rank}(\alpha) = 2$, $\text{rank}(\beta) \leq 2$, $\ker(\widehat{\alpha}) = \ker(\widehat{\beta})$ and $\text{coker}(\widehat{\alpha}) \neq \text{coker}(\widehat{\beta})$. Since $\rho_2 = \mu_2 \vee \rho_0$ by Proposition 3.25(v), it is sufficient to show that ξ contains both μ_2 and ρ_0 . In fact, it is enough to show that $\mu_2 \subseteq \xi$; indeed, this implies $\widehat{\alpha} \xi \alpha \xi \beta \xi \widehat{\beta}$, where $(\widehat{\alpha}, \widehat{\beta}) \in \rho_0 \setminus \Delta$, and hence Proposition 8.5(i) gives $\rho_0 = (\widehat{\alpha}, \widehat{\beta})^\# \subseteq \xi$. Now, one of the following must hold:

- (a) $\text{rank}(\beta) = 0$, (c) $\text{rank}(\beta) = 2$ and $\text{codom}(\alpha) \neq \text{codom}(\beta)$.
(b) $\text{rank}(\beta) = 2$ and $\text{codom}(\alpha) = \text{codom}(\beta)$, or

In each case, we define a Brauer element $\gamma \in \mathcal{B}_n$, and let the reader check that $(\alpha\gamma, \beta\gamma) \in \mu_2 \setminus \mu_{\mathcal{S}_2}$. It will then follow from Proposition 8.7(ii) that $\mu_2 \subseteq \xi$, as desired. Write $\alpha = \begin{pmatrix} a & b & A_1 & \cdots & A_{m-1} \\ x & y & B_1 & \cdots & B_{m-1} \end{pmatrix}$. In case (a), we put $\gamma = \begin{pmatrix} x & y & B_1 & \cdots & B_{m-1} \\ x & y & B_1 & \cdots & B_{m-1} \end{pmatrix}$. Next, suppose (b) holds. Choose some $(c, d) \in \text{coker}(\beta) \setminus \text{coker}(\alpha)$. Without loss of generality, we may assume that $B_{m-2} = \{c, e\}$ and $B_{m-1} = \{d, f\}$ for some e, f , and we define $\gamma = \begin{pmatrix} e & f & c, x & d, y & B_1 & \cdots & B_{m-3} \\ e & f & c, x & d, y & B_1 & \cdots & B_{m-3} \end{pmatrix}$. Finally, suppose (c) holds. Without loss of generality, we may assume that $y \notin \text{codom}(\beta)$, so that $\{y', w'\}$ is a block of β for some w . Write $\text{codom}(\beta) = \{u, v\}$, fix a 2-partition $\{C_1, \dots, C_{m-2}\}$ of $\mathbf{n} \setminus \{u, v, y, w\}$, and define $\gamma = \begin{pmatrix} y & w & u, v & C_1 & \cdots & C_{m-2} \\ y & w & u, v & C_1 & \cdots & C_{m-2} \end{pmatrix}$.

Next note that (ii) follows from (i) by duality. Finally, for (iii), fix some $(\alpha, \beta) \in R_2 \setminus (\lambda_2 \cup \rho_2 \cup R_{\mathcal{S}_2})$, and write $\xi = (\alpha, \beta)^\#$. Renaming α, β if necessary, we may assume that $\text{rank}(\alpha) = 2$, $\text{rank}(\beta) \leq 2$, $\ker(\widehat{\alpha}) \neq \ker(\widehat{\beta})$ and $\text{coker}(\widehat{\alpha}) \neq \text{coker}(\widehat{\beta})$. As above, write $\alpha = \begin{pmatrix} a & b & A_1 & \cdots & A_{m-1} \\ x & y & B_1 & \cdots & B_{m-1} \end{pmatrix}$. Similarly to part (i), since $R_2 = \mu_2 \vee R_0$ by Proposition 3.25(vi), it suffices to show that $\mu_2 \subseteq \xi$. One of the following must be the case:

- (d) $\text{rank}(\beta) = 0$, (f) $\text{rank}(\beta) = 2$ and $\text{dom}(\alpha) \cap \text{dom}(\beta) = \emptyset$.
(e) $\text{rank}(\beta) = 2$ and $\text{dom}(\alpha) \cap \text{dom}(\beta) \neq \emptyset$, or

In each case, we define a Brauer element $\gamma \in \mathcal{B}_n$ such that $(\gamma\alpha, \gamma\beta) \in \rho_2 \setminus (\mu_2 \cup \rho_{\mathcal{S}_2})$. It will then follow from part (i) that $\mu_2 \subseteq \rho_2 \subseteq \xi$. In cases (d) and (e), we define $\gamma = \begin{pmatrix} a & b & A_1 & \cdots & A_{m-1} \\ a & b & A_1 & \cdots & A_{m-1} \end{pmatrix}$. In case (f), we write $\text{dom}(\beta) = \{c, d\}$, fix a 2-partition $\{C_1, \dots, C_{m-2}\}$ of $\mathbf{n} \setminus \{a, b, c, d\}$, and define $\gamma = \begin{pmatrix} a & b & A_1 & A_2 & \cdots & A_{m-1} \\ a & b & c, d & C_1 & \cdots & C_{m-2} \end{pmatrix}$. \square

Remark 8.9. The congruences $\rho_{\mathcal{S}_2}$, $\lambda_{\mathcal{S}_2}$, $R_{\mathcal{S}_2}$, ρ_K , λ_K and R_K are not principal (cf. Remark 3.26), but each is generated by two pairs of Brauer elements. The pairs of generating pairs for each may be deduced in the manner of Remark 5.10.

We now turn to the upper congruences, specifically:

$$R_1 \subsetneq R_{A_3} \subsetneq R_{\mathcal{S}_3} \subsetneq R_3 \subsetneq \cdots \subsetneq R_n = \nabla \quad (n \text{ odd}), \quad R_K \subsetneq R_{A_4} \subsetneq R_{\mathcal{S}_4} \subsetneq R_4 \subsetneq \cdots \subsetneq R_n = \nabla \quad (n \text{ even}). \quad (8.10)$$

We begin with a series of results giving sufficient conditions for a congruence on \mathcal{B}_n to contain a Rees congruence R_q .

Lemma 8.11. *Suppose $\xi \in \text{Cong}(\mathcal{B}_n)$ and that $(\text{id}_n, \alpha) \in \xi$ for some $\alpha \in J_z$. Then $\xi = R_n$.*

Proof. We first show that $R_z \subseteq \xi$. Choose any $\beta \in J_z$ with $\ker(\beta) \neq \ker(\alpha)$ and $\text{coker}(\beta) \neq \text{coker}(\alpha)$. Then $\beta = \text{id}_n \beta \text{id}_n \xi \alpha \beta \alpha = \alpha$, and clearly $(\alpha, \beta) \in R_z \setminus (\rho_z \cup \lambda_z)$, so Proposition 8.6 gives $R_z = (\alpha, \beta)^\# \subseteq \xi$. Now the proof will be complete if we can show that every Brauer element is ξ -related to a Brauer element of rank z . So let $\gamma \in \mathcal{B}_n$. Then $\gamma = \gamma \text{id}_n \xi \gamma \alpha$, and since $\text{rank}(\gamma\alpha) \leq \text{rank}(\alpha) = z$, we are done. \square

Recall that group of units of \mathcal{B}_n is the symmetric group $\mathcal{S}_n = \{\alpha \in \mathcal{B}_n : \text{rank}(\alpha) = n\}$, and recall that, for any $\alpha \in \mathcal{S}_n$, α^* is the (group theoretic) inverse of α in \mathcal{S}_n .

Lemma 8.12. *Suppose $\xi \in \text{Cong}(\mathcal{B}_n)$ and that $(\text{id}_n, \alpha) \in \xi$ for some $\alpha \in \mathcal{B}_n$ with $\text{rank}(\alpha) < n$. Then $\xi = R_n$.*

Proof. We prove the lemma by induction on $\text{rank}(\alpha)$. If $\text{rank}(\alpha) = z$, then we are done, by Lemma 8.11, so suppose $\text{rank}(\alpha) \geq z + 2$. Inductively, it is enough to show that $(\text{id}_n, \beta) \in \xi$ for some $\beta \in \mathcal{B}_n$ with $\text{rank}(\beta) < \text{rank}(\alpha)$. Since $2 \leq \text{rank}(\alpha) \leq n - 2$, we may choose some $i, j \in \text{dom}(\alpha)$ with $i \neq j$, and some $(k, l) \in \text{coker}(\alpha)$ with $k \neq l$. Choose any $\sigma \in \mathcal{S}_n$ with $k\sigma = i$ and $l\sigma = j$. Then $\text{id}_n = \text{id}_n \sigma \text{id}_n \sigma^* \xi \alpha \sigma \alpha^*$, and $\text{rank}(\alpha \sigma \alpha^*) \leq \text{rank}(\alpha) - 2$, as required. \square

For $q \in \{z, z + 2, \dots, n\}$, let $\varepsilon_q = \overline{\text{id}}_q = \left(\begin{array}{c|c|c|c} 1 & \cdots & q & q+1, q+2 \cdots n-1, n \\ \cdots & \cdots & q & q+1, q+2 \cdots n-1, n \end{array} \right)$ denote the identity of the maximal subgroup $\overline{\mathcal{S}}_q$. Note that the subsemigroup $\varepsilon_q \mathcal{B}_n \varepsilon_q$ of \mathcal{B}_n is isomorphic to \mathcal{B}_q ; it consists of all Brauer elements that have the blocks $\{q+1, q+2\}, \dots, \{n-1, n\}$ and $\{(q+1)', (q+2)'\}, \dots, \{(n-1)', n'\}$.

Lemma 8.13. *Suppose $\xi \in \text{Cong}(\mathcal{B}_n)$ and that there exists $(\alpha, \beta) \in \xi$ with $q = \text{rank}(\alpha) \geq 3$ and $\text{rank}(\beta) < q$. Then $R_q \subseteq \xi$.*

Proof. We first claim that $R_z \subseteq \xi$. Write $\alpha = \left(\begin{array}{c|c|c|c} a_1 & \cdots & a_q & A_1 \cdots A_r \\ b_1 & \cdots & b_q & B_1 \cdots B_r \end{array} \right)$, and put

$$\gamma = \left(\begin{array}{c|c|c|c} 1 & \cdots & q & q+1, q+2 \cdots n-1, n \\ a_1 & \cdots & a_q & A_1 \cdots A_r \end{array} \right) \quad \text{and} \quad \delta = \left(\begin{array}{c|c|c|c} b_1 & \cdots & b_q & B_1 \cdots B_r \\ 1 & \cdots & q & q+1, q+2 \cdots n-1, n \end{array} \right).$$

Then $\varepsilon_q = \gamma \alpha \delta \xi \gamma \beta \delta$. But $\gamma \beta \delta \in \varepsilon_q \mathcal{B}_n \varepsilon_q$ and $\text{rank}(\gamma \beta \delta) \leq \text{rank}(\beta) < q$. By Lemma 8.12, and the fact that $\varepsilon_q \mathcal{B}_n \varepsilon_q$ is isomorphic to \mathcal{B}_q , it follows that all elements of $\varepsilon_q \mathcal{B}_n \varepsilon_q$ are $(\varepsilon_q, \gamma \beta \delta)^\sharp$ -related and, hence, ξ -related. In particular, if we let $\tau_1, \tau_2 \in \varepsilon_q \mathcal{B}_n \varepsilon_q$ be such that $\text{rank}(\tau_1) = \text{rank}(\tau_2) = z$, $\ker(\tau_1) \neq \ker(\tau_2)$ and $\text{coker}(\tau_1) \neq \text{coker}(\tau_2)$, then $(\tau_1, \tau_2) \in \xi$. But $(\tau_1, \tau_2) \in R_z \setminus (\rho_z \cup \lambda_z)$, so it follows from Proposition 8.6 that $R_z = (\tau_1, \tau_2)^\sharp \subseteq \xi$.

Now that we know all Brauer elements of rank z are ξ -related, the proof of the lemma will be complete if we can show any Brauer element of rank at most q is ξ -related to a Brauer element of rank z . With this in mind, let $\sigma \in \mathcal{B}_n$ with $p = \text{rank}(\sigma) \leq q$, and write $\sigma = \left(\begin{array}{c|c|c|c} c_1 & \cdots & c_p & C_1 \cdots C_s \\ d_1 & \cdots & d_p & D_1 \cdots D_s \end{array} \right)$. Define $\tau_3 = \left(\begin{array}{c|c|c|c} c_1 & \cdots & c_p & C_1 \cdots C_s \\ 1 & \cdots & p & p+1, p+2 \cdots n-1, n \end{array} \right)$ and $\tau_4 = \left(\begin{array}{c|c|c|c} 1 & \cdots & p & p+1, p+2 \cdots n-1, n \\ d_1 & \cdots & d_p & D_1 \cdots D_s \end{array} \right)$. Since $\varepsilon_p, \varepsilon_z \in \varepsilon_q \mathcal{B}_n \varepsilon_q$, we have $\varepsilon_p \xi \varepsilon_z$, by the previous paragraph. It follows that $\sigma = \tau_3 \varepsilon_p \tau_4 \xi \tau_3 \varepsilon_z \tau_4$, with $\text{rank}(\tau_3 \varepsilon_z \tau_4) = z$. As noted above, this completes the proof. \square

The previous result shows that a congruence identifying a Brauer element of rank $q \geq 3$ with a Brauer element of lower rank must contain the Rees congruence R_q . Our next goal is to give a condition under which a congruence that identifies two Brauer elements of equal rank $q \geq 3$ must contain R_q ; see Lemma 8.15. One of the key steps in the proof of Lemma 8.15 is true also for $q = 2$, and it will be convenient for later use to prove this intermediate result under this slightly more general hypothesis:

Lemma 8.14. *Suppose $\xi \in \text{Cong}(\mathcal{B}_n)$ and that $(\alpha, \beta) \in (\xi \setminus \mathcal{H}) \cap (J_q \times J_q)$ with $q \geq 2$. Then there exists $(\gamma, \delta) \in \xi$ with $\text{rank}(\gamma) = q$ and $\text{rank}(\delta) < q$.*

Proof. Since $(\alpha, \beta) \notin \mathcal{H}$, it follows that $(\alpha, \beta) \notin \mathcal{R}$ or $(\alpha, \beta) \notin \mathcal{L}$. By symmetry, we may assume that $(\alpha, \beta) \notin \mathcal{R}$, so $\ker(\alpha) \neq \ker(\beta)$. Write $\alpha = \left(\begin{array}{c|c|c|c} a_1 & \cdots & a_q & A_1 \cdots A_r \\ b_1 & \cdots & b_q & B_1 \cdots B_r \end{array} \right)$ and $\beta = \left(\begin{array}{c|c|c|c} c_1 & \cdots & c_q & C_1 \cdots C_r \\ d_1 & \cdots & d_q & D_1 \cdots D_r \end{array} \right)$.

Case 1. Suppose first that $\text{dom}(\alpha) = \text{dom}(\beta)$. Renaming if necessary, we may assume that A_1 is not a block of β . Write $A_1 = \{i, j\}$. Since $i, j \in \mathbf{n} \setminus \text{dom}(\alpha) = \mathbf{n} \setminus \text{dom}(\beta)$, we may assume that $C_1 = \{i, k\}$ and $C_2 = \{j, l\}$ for some k, l . Define $\sigma = \left(\begin{array}{c|c|c|c} i|j & a_3 & \cdots & a_q | a_1, a_2 | A_2 | A_3 \cdots | A_r \\ i|j & a_3 & \cdots & a_q | a_1, k | a_2, l | C_3 \cdots | C_r \end{array} \right)$. Then $\text{rank}(\sigma\alpha) = q - 2$ and $\text{rank}(\sigma\beta) = q$, so we put $\gamma = \sigma\beta$ and $\delta = \sigma\alpha$.

Case 2. Now suppose $\text{dom}(\alpha) \neq \text{dom}(\beta)$. Without loss of generality, we may assume that $a_q \notin \text{dom}(\beta)$. Denote the $\ker(\beta)$ -class of a_q by $\{a_q, x\}$, and let $\sigma \in \mathcal{B}_n$ be an arbitrary Brauer element of rank q such that $\text{codom}(\sigma)$ contains a_q, x , and $q - 2$ additional elements of $\{a_1, \dots, a_{q-1}\}$. Then $\text{rank}(\sigma\alpha) = q$ and $\text{rank}(\sigma\beta) \leq q - 2$, so we put $\gamma = \sigma\alpha$ and $\delta = \sigma\beta$. \square

Lemma 8.15. *Suppose $\xi \in \text{Cong}(\mathcal{B}_n)$ and that $(\alpha, \beta) \in (\xi \setminus \mathcal{H}) \cap (J_q \times J_q)$ with $q \geq 3$. Then $R_q \subseteq \xi$.*

Proof. By Lemma 8.14, there exists $(\gamma, \delta) \in \xi$ with $\text{rank}(\gamma) = q$ and $\text{rank}(\delta) < q$. It then follows from Lemma 8.13 that $R_q \subseteq \xi$. \square

For $1 \leq q \leq n$, and for a permutation $\pi \in \mathcal{S}_q$, we will write $\langle\langle \pi \rangle\rangle$ for the normal closure of π in \mathcal{S}_q . The next result concerns the permutations $\phi(\alpha, \beta)$ from Definition 5.5.

Lemma 8.16. *Let $3 \leq q \leq n$ with $q \equiv n \pmod{2}$, and let N be one of \mathcal{A}_q or \mathcal{S}_q . Suppose $\xi \in \text{Cong}(\mathcal{B}_n)$, and that $(\alpha, \beta) \in \xi \cap \mathcal{H} \cap (J_q \times J_q)$ is such that $N = \langle\langle \phi(\alpha, \beta) \rangle\rangle$. Then $R_{q-2} \subseteq \xi$.*

Proof. Write $\alpha = \left(\begin{array}{c|c|c|c} a_1 & \cdots & a_q & A_1 \cdots A_r \\ \hline b_1 & \cdots & b_q & B_1 \cdots B_r \end{array} \right)$ and $\beta = \left(\begin{array}{c|c|c|c} a_1 & \cdots & a_q & A_1 \cdots A_r \\ \hline b_{1\sigma} & \cdots & b_{q\sigma} & B_1 \cdots B_r \end{array} \right)$, where $a_1 < \cdots < a_q$, noting that $\phi(\alpha, \beta) = \sigma^{-1}$, so $N = \langle\langle \sigma \rangle\rangle$. Put $\gamma_1 = \left(\begin{array}{c|c|c|c} 1 & \cdots & q & q+1, q+2 \cdots n-1, n \\ \hline a_1 & \cdots & a_q & A_1 \cdots A_r \end{array} \right)$ and $\gamma_2 = \left(\begin{array}{c|c|c|c} b_1 & \cdots & b_q & B_1 \cdots B_r \\ \hline 1 & \cdots & q & q+1, q+2 \cdots n-1, n \end{array} \right)$, noting that $\varepsilon_q = \gamma_1 \alpha \gamma_2 \xi \gamma_1 \beta \gamma_2 = \bar{\sigma}$. Define

$$\delta_1 = \left(\begin{array}{c|c|c|c} 3 & 4 & 5 & \cdots & q & 1, 2 & q+1, q+2 & \cdots & n-1, n \\ \hline 3 & 4 & 5 & \cdots & q & 1, 2 & q+1, q+2 & \cdots & n-1, n \end{array} \right) \quad \text{and} \quad \delta_2 = \left(\begin{array}{c|c|c|c} 1 & 4 & 5 & \cdots & q & 2, 3 & q+1, q+2 & \cdots & n-1, n \\ \hline 1 & 4 & 5 & \cdots & q & 2, 3 & q+1, q+2 & \cdots & n-1, n \end{array} \right).$$

We claim that $(\delta_1, \delta_2) \in \xi$. In order to do this, let $\pi \in \mathcal{A}_q$ be the 3-cycle mapping $1 \mapsto 2 \mapsto 3 \mapsto 1$ and fixing each of $4, \dots, q$. Since $\mathcal{A}_q \subseteq N = \langle\langle \sigma \rangle\rangle$, we have $\pi = (\tau_1^{-1} \sigma \tau_1) \cdots (\tau_k^{-1} \sigma \tau_k)$ for some $k \geq 1$ and some $\tau_1, \dots, \tau_k \in \mathcal{S}_q$. It follows that $\bar{\pi} = (\bar{\tau}_1^* \bar{\sigma} \bar{\tau}_1) \cdots (\bar{\tau}_k^* \bar{\sigma} \bar{\tau}_k) \xi (\bar{\tau}_1^* \varepsilon_q \bar{\tau}_1) \cdots (\bar{\tau}_k^* \varepsilon_q \bar{\tau}_k) = \varepsilon_q$, and we also have $\bar{\pi}^* = \bar{\pi} \bar{\pi} \xi \varepsilon_q \varepsilon_q = \varepsilon_q$. But then $\delta_1 = \varepsilon_q \delta_1 \varepsilon_q \xi \bar{\pi}^* \delta_1 \bar{\pi} = \delta_2$, completing the proof of the claim. Note that $\text{rank}(\delta_1) = \text{rank}(\delta_2) = q - 2 \geq 1$, and that $(\delta_1, \delta_2) \notin \mathcal{R}$ and $(\delta_1, \delta_2) \notin \mathcal{L}$. It follows from Proposition 8.6 (if $q = 3$) or Proposition 8.8(iii) (if $q = 4$) or Lemma 8.15 (if $q \geq 5$) that $R_{q-2} \subseteq (\delta_1, \delta_2)^\# \subseteq \xi$. \square

The next result completes the proof of Theorem 8.4.

Proposition 8.17. *Consider the chains (8.10) of congruences on \mathcal{B}_n . Apart from the first congruence on the second list, all of the listed congruences are principal. Moreover, if ξ is any of the listed congruences other than the first of either list, and if $\alpha, \beta \in \mathcal{B}_n$, then $\xi = (\alpha, \beta)^\# \Leftrightarrow (\alpha, \beta) \in \xi \setminus \xi^-$, where ξ^- denotes the previous congruence in the same list.*

Proof. Let ξ be any of the listed congruences other than the first of either list. If $(\alpha, \beta) \notin \xi$ or if $(\alpha, \beta) \in \xi^-$, then clearly $(\alpha, \beta)^\# \neq \xi$. Conversely, suppose $(\alpha, \beta) \in \xi \setminus \xi^-$, and write $\zeta = (\alpha, \beta)^\#$. The proof will be complete if we can show that $\xi \subseteq \zeta$.

Case 1. Suppose first that $\xi = R_q$ for some $q \geq 3$. So $(\alpha, \beta) \in R_q \setminus R_{\mathcal{S}_q}$. Thus, renaming α, β if necessary, we have $\text{rank}(\alpha) = q$, and either $\text{rank}(\beta) < q$ or else $\text{rank}(\beta) = q$ and $(\alpha, \beta) \notin \mathcal{H}$. It then follows from Lemma 8.13 or 8.15, respectively, that $\xi = R_q \subseteq \zeta$.

Case 2. Now suppose $\xi = R_N$, where N is one of \mathcal{A}_q or \mathcal{S}_q for some $q \geq 3$. Let H be the largest normal subgroup of \mathcal{S}_q strictly contained in N , noting that $\xi^- = R_H$. (Recall that $R_{q-2} = R_{\{\text{id}_q\}}$.) Because $(\alpha, \beta) \in \xi \setminus \xi^- = \nu_N \setminus \nu_H$, it follows that $\text{rank}(\alpha) = \text{rank}(\beta) = q$, $\alpha \notin \mathcal{H} \beta$ and $\phi(\alpha, \beta) \in N \setminus H$. Consequently, we have $N = \langle\langle \phi(\alpha, \beta) \rangle\rangle$, so Lemma 8.16 gives $R_{q-2} \subseteq \zeta$. Now suppose $(\gamma, \delta) \in R_N \setminus R_{q-2}$. The proof will be complete if we can show that $(\gamma, \delta) \in \zeta$. Write $\gamma = \left(\begin{array}{c|c|c|c} a_1 & \cdots & a_q & A_1 \cdots A_r \\ \hline b_1 & \cdots & b_q & B_1 \cdots B_r \end{array} \right)$ and $\delta = \left(\begin{array}{c|c|c|c} a_1 & \cdots & a_q & A_1 \cdots A_r \\ \hline b_{1\pi} & \cdots & b_{q\pi} & B_1 \cdots B_r \end{array} \right)$, where $a_1 < \cdots < a_q$, noting that $\pi = \phi(\gamma, \delta)^{-1} \in N$. As in the proof of Lemma 8.16, we may use the fact that $\pi \in N = \langle\langle \phi(\alpha, \beta) \rangle\rangle$ to show that $(\varepsilon_q, \bar{\pi}) \in \zeta$. But then $(\gamma, \delta) = (\tau_1 \varepsilon_q \tau_2, \tau_1 \bar{\pi} \tau_2) \in \zeta$, where $\tau_1 = \left(\begin{array}{c|c|c|c} a_1 & \cdots & a_q & A_1 \cdots A_r \\ \hline 1 & \cdots & q & q+1, q+2 \cdots n-1, n \end{array} \right)$ and $\tau_2 = \left(\begin{array}{c|c|c|c} 1 & \cdots & q & q+1, q+2 \cdots n-1, n \\ \hline b_1 & \cdots & b_q & B_1 \cdots B_r \end{array} \right)$. \square

We conclude this section with a number of observations. Recall that the symmetric inverse monoid \mathcal{I}_n is (isomorphic to) a submonoid of \mathcal{P}_n , and that we utilised a surjective map $\Phi_{\mathcal{P}_n, \mathcal{I}_n} : \text{Cong}(\mathcal{P}_n) \rightarrow \text{Cong}(\mathcal{I}_n)$ in the proof of Theorem 5.4 (see especially Lemmas 5.7, 5.15 and Proposition 5.16). At the beginning of this section, we noted that the symmetric inverse monoid \mathcal{I}_n does not embed into the Brauer monoid \mathcal{B}_n . However, for $n = 2m$ even, \mathcal{I}_m does embed into the even degree Brauer monoid \mathcal{B}_{2m} . Such an embedding $\mathcal{I}_m \rightarrow \mathcal{B}_{2m} : \alpha \mapsto \tilde{\alpha}$ is illustrated by example in Figure 8. Write $S \subseteq \mathcal{B}_{2m}$ for the image of this embedding. As in Subsection 2.4, we then obtain mappings

$$\Phi = \Phi_{\mathcal{B}_{2m}, S} : \text{Cong}(\mathcal{B}_{2m}) \rightarrow \text{Cong}(S) : \xi \mapsto \xi^S = \xi \cap (S \times S),$$

$$\Psi = \Psi_{\mathcal{B}_{2m}, S} : \text{Cong}(S) \rightarrow \text{Cong}(\mathcal{B}_{2m}) : \zeta \mapsto \zeta_{\mathcal{B}_{2m}}^\sharp.$$

But we note that neither Φ nor Ψ is injective, and neither is surjective. For example, one may check that

$$R_{\mathcal{S}_{2q}}\Phi = R_{\mathcal{A}_{2q}}\Phi = R_{\mathcal{S}_q}^{\mathcal{I}_m} \quad \text{and} \quad R_{\mathcal{S}_q}^{\mathcal{I}_m}\Psi = R_{\mathcal{A}_q}^{\mathcal{I}_m}\Psi = R_{\mathcal{A}_{2q}} \quad \text{for any } 3 \leq q \leq n. \quad (8.18)$$

The reason for (8.18) is that, by the nature of the embedding $\mathcal{I}_m \rightarrow \mathcal{B}_{2m}$, $\phi(\tilde{\alpha}, \tilde{\beta})$ is always an even permutation for any $\alpha, \beta \in \mathcal{I}_n$ with $\alpha \mathcal{H} \beta$, regardless of the parity of $\phi(\alpha, \beta)$. Curiously, though, we note that $R_{\mathcal{S}_2}^{\mathcal{I}_m}\Psi = \mu_K$.

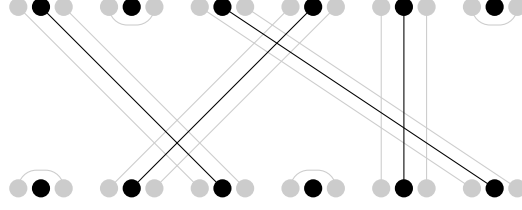

Figure 8: A partial permutation $\alpha \in \mathcal{I}_6$ (black), with its corresponding Brauer element $\tilde{\alpha} \in \mathcal{B}_{12}$ (gray).

9 The Jones monoid \mathcal{J}_n

Recall that the Jones monoid $\mathcal{J}_n = \mathcal{B}_n \cap \mathcal{PP}_n$ consists of all *planar* Brauer elements. In this final section, we describe the congruence lattice of \mathcal{J}_n . Recall that in Section 7 we were able to deduce descriptions of the planar congruence lattices $\text{Cong}(\mathcal{PP}_n)$ and $\text{Cong}(\mathcal{M}_n)$ by easily modifying the arguments used to treat their nonplanar counterparts $\text{Cong}(\mathcal{P}_n)$ and $\text{Cong}(\mathcal{PB}_n)$. Unfortunately, and perhaps intriguingly, there does not appear to be a simple method for deriving a description of $\text{Cong}(\mathcal{J}_n)$ from $\text{Cong}(\mathcal{B}_n)$. Roughly speaking, the reason for this is largely to do with the freedom (or lack thereof) in defining Motzkin or Jones elements. For example, if we wish to define a Motzkin element $\alpha \in \mathcal{M}_n$ to have k specified non-singleton blocks, we must only ensure that those blocks of α may be drawn in planar fashion, as the remaining blocks may be left as singletons. However, if we wish to define a *Jones* element $\alpha \in \mathcal{J}_n$ to have k specified non-singleton blocks, we must ensure that it is possible to define the remaining $n - k$ (also non-singleton) blocks, without interfering with the planarity of α . We will discuss this in more detail later.

As in the previous section, we fix $n \geq 3$ and $z \in \{0, 1\}$ with $z \equiv n \pmod{2}$. The \mathcal{J} -classes of \mathcal{J}_n are $J_q = \{\alpha \in \mathcal{J}_n : \text{rank}(\alpha) = q\}$, for $q = z, z + 2, \dots, n$, the ideals are $I_q = J_z \cup \dots \cup J_q$, and the corresponding Rees congruences are denoted by $R_q = R_{I_q}$ (Definition 3.1). When n is odd, we take the identity retraction on I_1 to get a retractable IN-pair $\mathcal{C}_1 = (I_1, \{\overline{\text{id}}_3\})$ and three congruences λ_1, ρ_1 and $\mu_1 = \Delta$ (Definition 3.18). For n even, it is easy to see that the retraction $f : \alpha \mapsto \widehat{\alpha}$ on \mathcal{B}_n (Definition 8.1 and Lemma 8.2) preserves planarity, so it follows that I_2 is a retractable ideal of \mathcal{J}_n . We then have retractable IN-pairs $\mathcal{C}_0 = (I_0, \{\overline{\text{id}}_2\})$ and $\mathcal{C}_2 = (I_2, \{\overline{\text{id}}_4\})$, yielding the congruences $\lambda_0, \rho_0, \mu_0 (= \Delta), \lambda_2, \rho_2, \mu_2$, respectively. Again, no ideal I_q of \mathcal{J}_n with $q \geq 3$ is retractable. Since \mathcal{J}_n is \mathcal{H} -trivial, there are no proper IN-pairs, and so no R_N congruences (Definition 3.16).

Theorem 9.1. *Let $n \geq 3$, and let \mathcal{J}_n be the Jones monoid of degree n . Also let $z \in \{0, 1\}$ be such that $n \equiv z \pmod{2}$.*

- (i) *The ideals of \mathcal{J}_n are the sets I_q , for $q = z, z + 2, \dots, n$, yielding the Rees congruences $R_q = R_{I_q}$, as in Definition 3.1.*
- (ii) *For n odd, the only retractable IN-pair of \mathcal{J}_n is $\mathcal{C}_1 = (I_1, \{\overline{\text{id}}_3\})$, yielding the congruences λ_1, ρ_1, μ_1 , as in Definition 3.18.*
- (iii) *For n even, the retractable IN-pairs of \mathcal{J}_n are $\mathcal{C}_0 = (I_0, \{\overline{\text{id}}_2\})$ and $\mathcal{C}_2 = (I_2, \{\overline{\text{id}}_4\})$, yielding the congruences $\lambda_0, \rho_0, \mu_0, \lambda_2, \rho_2, \mu_2$, respectively, as in Definition 3.18.*
- (iv) *The above congruences are distinct, and they exhaust all the congruences of \mathcal{J}_n .*
- (v) *The Hasse diagram of the congruence lattice $\text{Cong}(\mathcal{J}_n)$ is shown in Figure 9.*
- (vi) *The $*$ -congruences of \mathcal{J}_n are the same, but with λ_1, ρ_1 (n odd) or $\lambda_0, \lambda_2, \rho_0, \rho_2$ (n even) excluded.*

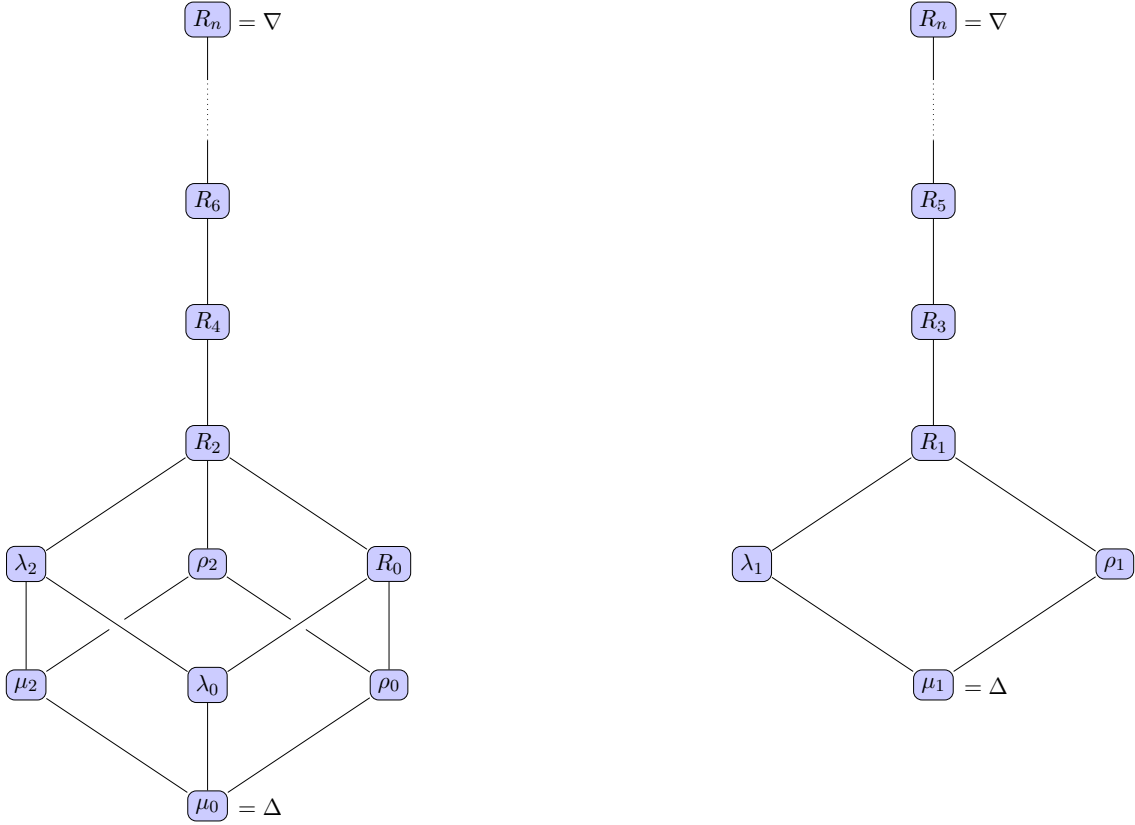

Figure 9: Hasse diagrams for the congruence lattice $\text{Cong}(\mathcal{J}_n)$ in the case of n even (left) and n odd (right). All congruences are principal.

We will prove the theorem separately for n even and for n odd, beginning now with the even case.

Proof of Theorem 9.1 for n even. Suppose $n = 2m$ is even. We have already mentioned that the Jones monoid $\mathcal{J}_n = \mathcal{J}_{2m}$ is isomorphic to the planar partition monoid \mathcal{PP}_m [17, 20]. Since we have already described the congruence lattice of \mathcal{PP}_m (see Theorem 7.3), we automatically obtain a description of $\text{Cong}(\mathcal{J}_{2m})$. To see that this agrees with the description given in Theorem 9.1, we need to recall the exact definition of the isomorphism between \mathcal{PP}_m and \mathcal{J}_{2m} . We follow [17, p873] and describe such an isomorphism $\mathcal{PP}_m \rightarrow \mathcal{J}_{2m} : \alpha \mapsto \tilde{\alpha}$ by example in Figure 10; the fact that this map is well defined follows from the planarity of the *canonical graphs* of planar partitions, as defined in Section 7 (see Lemma 7.1). Of importance is the fact that $\text{rank}(\tilde{\alpha}) = 2 \text{rank}(\alpha)$ for any $\alpha \in \mathcal{PP}_m$. It follows that $\xi \mapsto \tilde{\xi} = \{(\tilde{\alpha}, \tilde{\beta}) : (\alpha, \beta) \in \xi\}$ defines an isomorphism $\text{Cong}(\mathcal{PP}_m) \rightarrow \text{Cong}(\mathcal{J}_{2m})$. It is now a routine matter to verify that under this isomorphism the congruences $R_q, \lambda_0, \lambda_1, \rho_0, \rho_1, \mu_0, \mu_1$ of \mathcal{PP}_m , as established by Theorem 7.3, respectively correspond to the congruences $R_{2q}, \lambda_0, \lambda_2, \rho_0, \rho_2, \mu_0, \mu_2$ of \mathcal{J}_n . \square

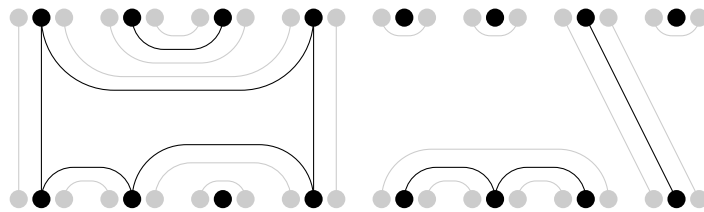

Figure 10: A planar partition $\alpha \in \mathcal{PP}_8$ (black), with its corresponding Jones element $\tilde{\alpha} \in \mathcal{J}_{16}$ (gray).

The proof of Theorem 9.1 in the odd case follows the same pattern as the proofs of our previous main theorems. At several points, we will appeal back to the fact that the even case is true. In particular, we require the next result, which follows immediately from parts (i) and (ii) of Proposition 7.5, together with the isomorphism $\mathcal{PP}_m \rightarrow \mathcal{J}_{2m} : \alpha \mapsto \tilde{\alpha}$ described in the above proof.

Proposition 9.2 (cf. Proposition 7.5). *For $n \geq 4$ even, the relations ρ_0 and λ_0 are principal congruences on \mathcal{J}_n . Moreover, if $\alpha, \beta \in \mathcal{J}_n$, then*

$$(i) \quad \rho_0 = (\alpha, \beta)^\# \Leftrightarrow (\alpha, \beta) \in \rho_0 \setminus \Delta, \quad (ii) \quad \lambda_0 = (\alpha, \beta)^\# \Leftrightarrow (\alpha, \beta) \in \lambda_0 \setminus \Delta. \quad \square$$

Next, we introduce some notation, and discuss some concepts relating to planarity. The following definition makes no assumption on the parity of n .

Definition 9.3. For $A \subseteq \mathbf{n}$, write $A = \{a_1 < \dots < a_k\}$ to indicate that $A = \{a_1, \dots, a_k\}$ and $a_1 < \dots < a_k$. For $i, j \in \mathbf{n}$, denote the interval $\{k \in \mathbf{n} : i \leq k \leq j\}$ by $[i, j]$. Let $A = \{a < b\}$ and $B = \{c < d\}$ be two disjoint subsets of \mathbf{n} of size 2. As in Section 7, we say A and B are *nested* if $a < c < d < b$ or $c < a < b < d$; we say A and B are *separated* if $a < b < c < d$ or $c < d < a < b$. As in Section 8, we say a partition of a set is a 2-partition if each block has size 2. We say a 2-partition of an interval $I \subseteq \mathbf{n}$ is *planar* if any pair of blocks is either nested or separated.

It is clear that a planar 2-partition exists on an interval $I \subseteq \mathbf{n}$ if and only if $|I|$ is even, in which case the number of distinct planar 2-partitions is given by a suitable Catalan number [1, Sequence A000108]. It is also clear that if $A = \{a < b\}$ is a block of a planar 2-partition of an interval, then one of a, b is even and the other odd; we call A *even* or *odd* according to whether $a = \min(A)$ is even or odd, respectively. It is easy to check that a planar 2-partition on an interval is uniquely determined by its odd (respectively, even) blocks. From this we immediately deduce the following.

Lemma 9.4. *Suppose \mathbf{P}, \mathbf{Q} are two planar 2-partitions of an interval $I \subseteq \mathbf{n}$ with $\mathbf{P} \neq \mathbf{Q}$. Then, renaming \mathbf{P}, \mathbf{Q} if necessary, there exists an even block and an odd block of \mathbf{P} , neither of which is a block of \mathbf{Q} . \square*

To see the relevance of planar 2-partitions, consider a Jones element $\alpha = \left(\begin{array}{c|c|c|c} a_1 & \dots & a_q & A_1 \dots A_r \\ b_1 & \dots & b_q & B_1 \dots B_r \end{array} \right) \in \mathcal{J}_n$, where n is arbitrary, and where $a_1 < \dots < a_q$ (and, of course, $q \equiv n \pmod{2}$). By planarity (cf. Lemma 7.1), we also have $b_1 < \dots < b_q$, and the non-transversals of α induce planar 2-partitions of the intervals

$$[1, a_1 - 1], [a_1 + 1, a_2 - 1], \dots, [a_{q-1} + 1, a_q - 1], [a_q + 1, n], \\ [1, b_1 - 1], [b_1 + 1, b_2 - 1], \dots, [b_{q-1} + 1, b_q - 1], [b_q + 1, n].$$

Note that some of these intervals may be empty. Since all the above intervals must have even size, it follows that a_i, b_i are both odd when i is odd, or both even when i is even: that is, $a_i \equiv b_i \equiv i \pmod{2}$. Note also that for any upper non-transversal $A_k = \{x < y\}$, and for any $1 \leq i \leq q$, we have either $y < a_i$ or $a_i < x$.

Remark 9.5. At several stages in the subsequent argument, we will need to define a Jones element $\alpha \in \mathcal{J}_n$ with specified $\text{dom}(\alpha) = \{a_1 < \dots < a_q\}$, $\text{codom}(\alpha) = \{b_1 < \dots < b_q\}$, and a single extra non-transversal $\{x, y\}$ or $\{x', y'\}$ for some $x, y \in \mathbf{n}$. Keeping the previous paragraph in mind, we must be careful to ensure that $q \equiv n \pmod{2}$, that $a_i \equiv b_i \equiv i \pmod{2}$ for all i , that one of x, y is even and the other odd, and that the specified non-transversal does not intersect any of the transversals $\{a_i, b'_i\}$. Conversely, it is easy to see that if these conditions are satisfied, then such a required Jones element $\alpha \in \mathcal{J}_n$ exists.

With the above concepts in place, we are now ready to investigate the congruences on odd-degree \mathcal{J}_n . For the rest of this section, unless otherwise specified, we assume $n = 2m + 1 \geq 3$ is odd. We begin with the lower congruences, ρ_1 , λ_1 and R_1 . The first main step is to prove that ρ_1 and λ_1 are principal (Proposition 9.10); the pattern of proof is similar to that of Proposition 8.5, but the planarity restriction on Jones elements means that we have to work quite a bit harder. For convenience, we will divide the argument into a number of technical lemmas.

Lemma 9.6. *Let $n \geq 3$ be odd, and let $(\alpha, \beta) \in \rho_1 \setminus \Delta$. For any $\sigma \in \mathcal{J}_n$ with $\text{rank}(\sigma) = 1$, there exists some $\pi \in \mathcal{J}_n$ with $(\sigma, \pi) \in (\alpha, \beta)^\#$ and $\text{codom}(\pi) = \{n\}$.*

Proof. Write $\xi = (\alpha, \beta)^\#$ and $\sigma = \left(\begin{array}{c|c|c|c} a & A_1 & \dots & A_m \\ b & B_1 & \dots & B_m \end{array} \right)$, noting that a, b are both odd. If $b = n$, then there is nothing to prove, so suppose $b \neq n$. Without loss of generality, we may assume that $n \in B_1$, and we may write $B_1 = \{w, n\}$. By planarity, we have $b < w < n$, and w is even. We will prove that $\sigma \xi \pi$, where $\pi = \left(\begin{array}{c|c|c|c} a & A_1 & A_2 & \dots & A_m \\ b, w & B_2 & \dots & B_m \end{array} \right)$. To do this, we will define a Jones element $\tau \in \mathcal{J}_n$ such that

$$\sigma = \sigma\alpha\tau \quad \text{and} \quad \pi = \sigma\beta\tau \quad \text{or} \quad \sigma = \sigma\beta\tau \quad \text{and} \quad \pi = \sigma\alpha\tau. \quad (9.7)$$

The exact definition of τ varies according to several possible cases we will enumerate below. But in every case, we will have $\text{codom}(\tau) = \{b, w, n\}$, and the non-trivial $\text{coker}(\tau)$ -classes will be B_2, \dots, B_m . Let the transversals of α and β be $\{c, d'\}$ and $\{c, e'\}$, respectively, noting that c, d, e are all odd.

Case 1. Suppose first that $d \neq e$. Without loss of generality, we may assume that $d < e$. Since d, e are odd, we may define $\text{dom}(\tau) = \{d, d + 1, e\}$, and we choose the non-trivial $\text{ker}(\tau)$ -classes arbitrarily. Then one may easily check that $\sigma = \sigma\alpha\tau$, while $\pi = \sigma\beta\tau$, as required.

Case 2. Now suppose $d = e$, noting that this forces $n \geq 5$. Recall that $\text{codom}(\alpha) = \text{codom}(\beta) = \{d\}$. So $\text{coker}(\alpha)$ induces two planar 2-partitions \mathbf{P}_1 and \mathbf{P}_2 of the intervals $[1, d - 1]$ and $[d + 1, n]$, respectively. Similarly, $\text{coker}(\beta)$ induces two planar 2-partitions \mathbf{Q}_1 and \mathbf{Q}_2 of the intervals $[1, d - 1]$ and $[d + 1, n]$, respectively. Since $\text{coker}(\alpha) \neq \text{coker}(\beta)$, we must have either $\mathbf{P}_1 \neq \mathbf{Q}_1$ or $\mathbf{P}_2 \neq \mathbf{Q}_2$. We consider these possibilities separately.

Subcase 2.1. Suppose first that $\mathbf{P}_1 \neq \mathbf{Q}_1$. By Lemma 9.4, renaming α, β if necessary, we may choose some block $\{x < y\}$ of \mathbf{P}_1 that is not a block of \mathbf{Q}_1 , with x odd. Let the blocks of \mathbf{Q}_1 containing x and y be $\{x, u\}$ and $\{y, v\}$. Note that y, u are even, and v is odd. Also, considering that $\{x', u'\}$ and $\{y', v'\}$ are both blocks of β , planarity ensures that we must be in one of the following eight cases:

- (a) $v < u < x < y < d$, (c) $u < x < y < v < d$, (e) $x < u < v < y < d$, (g) $x < v < y < u < d$, or
(b) $u < x < v < y < d$, (d) $v < x < u < y < d$, (f) $x < u < y < v < d$, (h) $x < y < v < u < d$.

Depending on the case we are in, we then define $\text{dom}(\tau)$ to be

- (a) $\{v, u, x\}$, (c) $\{1, u, x\}$, (e) $\{x, u, v\}$, (g) $\{x, y, y + 1\}$, or
(b) $\{1, u, x\}$, (d) $\{v, v + 1, x\}$, (f) $\{x, u, u + 1\}$, (h) $\{x, y, v\}$,

respectively. In each of cases (a–f), we specify that $\{y, d\}$ is a $\text{ker}(\tau)$ -class. In cases (g) and (h), we specify that $\{u, d\}$ is a $\text{ker}(\tau)$ -class. In all cases, all other non-trivial $\text{ker}(\tau)$ -classes may be chosen arbitrarily. Figure 11 gives a diagrammatic verification that equation (9.7) holds in each of cases (a)–(h). In Figure 11, we have only pictured: the single transversal $\{c, d'\}$ of α and β ; the non-transversal $\{x', y'\}$ of α ; the non-transversals $\{x', u'\}$ and $\{y', v'\}$ of β ; the three transversals of τ ; and the single specified upper non-transversal of τ . In light of Remark 9.5, odd-labelled vertices are drawn black, and even-labelled vertices white, so that the reader may easily check that τ is well defined in all cases. For reasons of space, we have omitted (double) dashes on vertices, and we have written $i^+ = i + 1$ for any $i \in \mathbf{n}$. No suggestion of the actual values of b, c, d, u, v, w, x, y are intended, but the ordering of the points b, w, n and of u, v, x, y, d are accurate in each diagram; note, however, that no suggestion of the relative ordering of a point from the first list and a point from the second list is intended in the diagram (so, for example, in any diagram, we could have $b < v$, $b = v$ or $b > v$).

Subcase 2.2. Now suppose $\mathbf{P}_2 \neq \mathbf{Q}_2$. By Lemma 9.4, renaming α, β if necessary, we may choose some block $\{x < y\}$ of \mathbf{P}_2 that is not a block of \mathbf{Q}_2 , with x even. Let the blocks of \mathbf{Q}_2 containing x and y be $\{x, u\}$ and $\{y, v\}$. This time, note that y, u are odd, and v is even. Again, planarity ensures that we are in one of the following eight cases:

- (a) $d < v < u < x < y$, (c) $d < u < x < y < v$, (e) $d < x < u < v < y$, (g) $d < x < v < y < u$, or
(b) $d < u < x < v < y$, (d) $d < v < x < u < y$, (f) $d < x < u < y < v$, (h) $d < x < y < v < u$.

Depending on the case we are in, we then define $\text{dom}(\tau)$ to be

- (a) $\{u, x, y\}$, (c) $\{y, v, n\}$, (e) $\{u, v, y\}$, (g) $\{y, y + 1, u\}$, or
(b) $\{x + 1, v, y\}$, (d) $\{v + 1, x, y\}$, (f) $\{y, v, n\}$, (h) $\{y, v, u\}$,

respectively. In cases (a) and (d), we specify that $\{d, v\}$ is a $\ker(\tau)$ -class. In all other cases, we specify that $\{d, x\}$ is a $\ker(\tau)$ -class. In all cases, all other non-trivial $\ker(\tau)$ -classes may be chosen arbitrarily. The reader may draw diagrams such as those in Figure 11 to verify that τ has the desired properties. \square

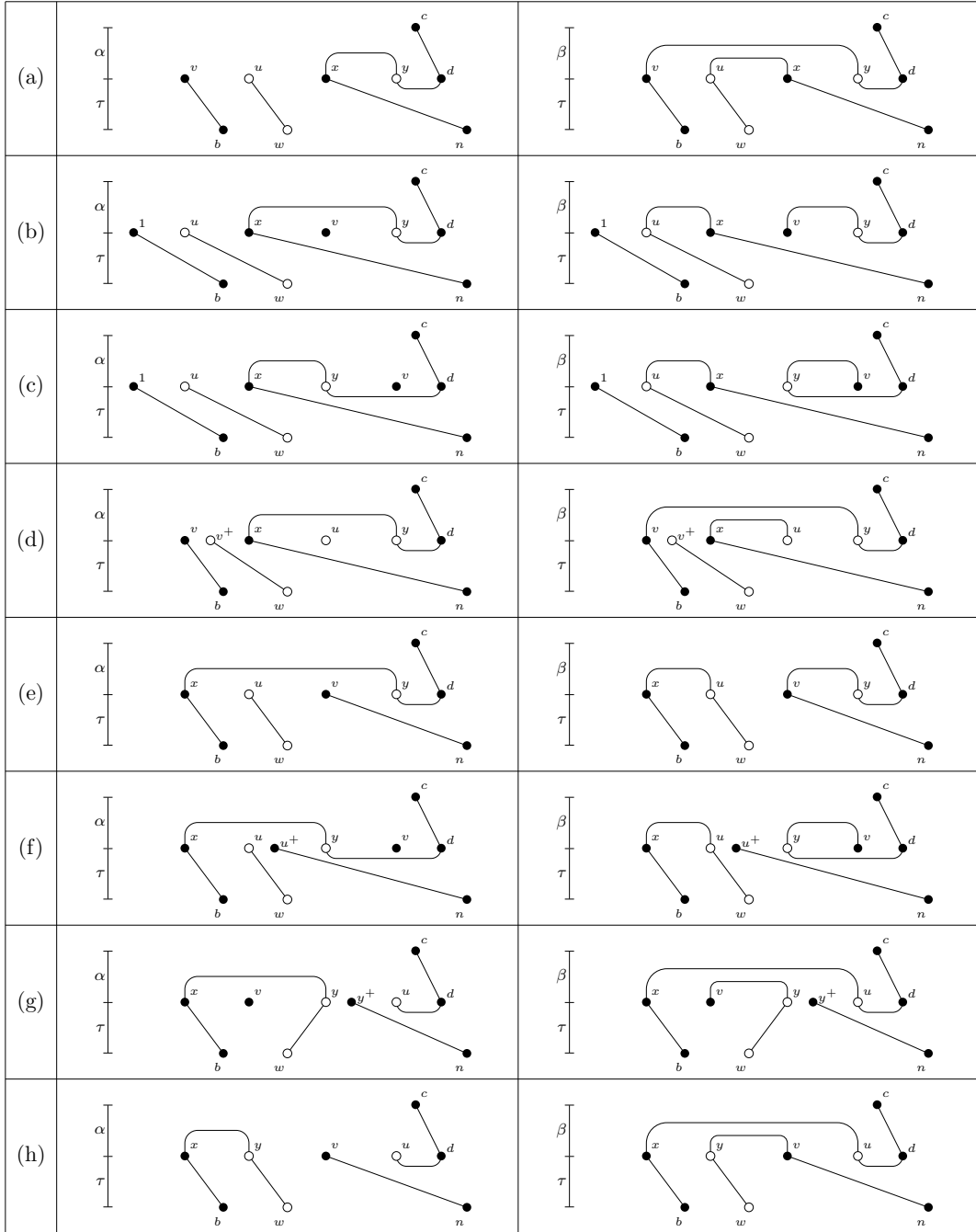

Figure 11: Verification of equation (9.7); see the proof of Lemma 9.6 for more details.

As in the proof of Proposition 8.5, for an integer i , we write $H_i = \{2i - 1, 2i\}$. The proof of the next result could be extracted from a section of the proof of Proposition 8.5, but we provide the details here for convenience.

Lemma 9.8. *Let $n \geq 5$ be odd, and let $(\alpha, \beta) \in \rho_1 \setminus \Delta$. Then $(\gamma, \delta) \in (\alpha, \beta)^\sharp$, where*

$$\gamma = \left(n \begin{array}{c|c|c|c} H_1 & \cdots & H_m \\ \hline H_1 & \cdots & H_m \end{array} \right) \quad \text{and} \quad \delta = \left(n \begin{array}{c|c|c|c} H_1 & \cdots & H_{m-2} & H_{m-1} \\ \hline H_1 & \cdots & H_{m-2} & n-4, n-1 \\ & & & n-3, n-2 \end{array} \right).$$

Proof. Write $\xi = (\alpha, \beta)^\sharp$. First, define $\sigma = \left(n \begin{array}{c|c|c|c} H_1 & \cdots & H_{m-1} & H_m \\ \hline n-2 & H_1 & \cdots & H_{m-1} \\ & & & n-1, n \end{array} \right)$. The proof of Lemma 9.6 gives $\sigma \xi \gamma$; in the notation of that proof, $a = n$, $b = n-2$ and $w = n-1$. Define $\tau_1 = \left(n-2 \begin{array}{c|c|c|c} n-1 & n & H_1 & \cdots & H_{m-2} & H_{m-1} \\ \hline n-4 & n-3 & n-2 & H_1 & \cdots & H_{m-2} \\ & & & & & n-1, n \end{array} \right)$ and $\tau_2 = \left(n-2 \begin{array}{c|c|c|c} n-1 & n & H_1 & \cdots & H_{m-2} & H_{m-1} \\ \hline n-4 & n-1 & n & H_1 & \cdots & H_{m-2} \\ & & & & & n-3, n-2 \end{array} \right)$. Then $\gamma \xi \sigma = \gamma \tau_1 \xi \sigma \tau_1 = \sigma \tau_2 \xi \gamma \tau_2 = \delta$. \square

Lemma 9.9. *Let $n \geq 3$ be odd, and let $(\alpha, \beta) \in \rho_1 \setminus \Delta$. Let $\tau_1, \tau_2 \in \mathcal{J}_n$ be such that $\text{dom}(\tau_1) = \text{codom}(\tau_1) = \text{dom}(\tau_2) = \text{codom}(\tau_2) = \{n\}$ and $\ker(\tau_1) = \ker(\tau_2)$. Then $(\tau_1, \tau_2) \in (\alpha, \beta)^\sharp$.*

Proof. If $n = 3$, then the assumptions force $\tau_1 = \tau_2$, so we assume $n \geq 5$ for the rest of the proof. Let γ, δ be as in Lemma 9.8. Write S for the submonoid of \mathcal{J}_n consisting of all Jones elements containing the block $\{n, n'\}$. Note that S is isomorphic to \mathcal{J}_{n-1} , and that $\gamma, \delta, \tau_1, \tau_2 \in S$. For $\sigma \in S$, write σ^\vee for the element of \mathcal{J}_{n-1} obtained from σ by removing the block $\{n, n'\}$. Write ξ for the ρ_0 -congruence on \mathcal{J}_{n-1} . By Proposition 9.2, $\xi = (\gamma^\vee, \delta^\vee)^\sharp$. So $(\tau_1^\vee, \tau_2^\vee) \in (\gamma^\vee, \delta^\vee)^\sharp$, and it follows that $(\tau_1, \tau_2) \in (\gamma, \delta)^\sharp \subseteq (\alpha, \beta)^\sharp$, as required. \square

Proposition 9.10. *Let $n \geq 3$ be odd. The relations ρ_1 and λ_1 are principal congruences on \mathcal{J}_n . Moreover, if $\alpha, \beta \in \mathcal{J}_n$, then*

$$(i) \quad \rho_1 = (\alpha, \beta)^\sharp \Leftrightarrow (\alpha, \beta) \in \rho_1 \setminus \Delta, \quad (ii) \quad \lambda_1 = (\alpha, \beta)^\sharp \Leftrightarrow (\alpha, \beta) \in \lambda_1 \setminus \Delta.$$

Proof. As usual, it suffices to prove the converse implication in (i), so fix some $(\alpha, \beta) \in \rho_1 \setminus \Delta$, and write $\xi = (\alpha, \beta)^\sharp$. Let $(\sigma_1, \sigma_2) \in \rho_1 \setminus \Delta$ be arbitrary. By Lemma 9.6, $\sigma_1 \xi \pi_1$ and $\sigma_2 \xi \pi_2$, for some $\pi_1, \pi_2 \in \mathcal{J}_n$ with $\text{codom}(\pi_1) = \text{codom}(\pi_2) = \{n\}$, and we note that $\ker(\pi_1) = \ker(\sigma_1) = \ker(\sigma_2) = \ker(\pi_2)$, since $\xi \subseteq \rho_1$. Let γ be as in Lemma 9.8, and put $\tau_1 = \gamma\pi_1$ and $\tau_2 = \gamma\pi_2$. Then τ_1, τ_2 satisfy the conditions of Lemma 9.9, so it follows by that lemma that $\tau_1 \xi \tau_2$. But then $\sigma_1 \xi \pi_1 = \pi_1\gamma\pi_1 = \pi_1\tau_1 \xi \pi_1\tau_2 = \pi_1\gamma\pi_2 = \pi_2 \xi \sigma_2$; note that $\pi_1\gamma\pi_2 = \pi_2$ follows from the fact that $\ker(\pi_1) = \ker(\pi_2)$. \square

The proof of the next result is virtually identical to that of Proposition 8.6.

Proposition 9.11. *Let $n \geq 3$ be odd. Then R_1 is a principal congruence on \mathcal{J}_n . Moreover, if $\alpha, \beta \in \mathcal{J}_n$, then $R_1 = (\alpha, \beta)^\sharp \Leftrightarrow (\alpha, \beta) \in R_1 \setminus (\rho_1 \cup \lambda_1)$.* \square

Having now described the generating pairs for the lower congruences ρ_1, λ_1, R_1 , we turn our attention to the chain of Rees congruences:

$$R_1 \subsetneq R_3 \subsetneq R_5 \subsetneq \cdots \subsetneq R_n = \nabla.$$

Specifically, we wish to show that each congruence in this list is principal, and that if $q \geq 3$ is odd, then R_q is generated by any pair from $R_q \setminus R_{q-2}$; see Proposition 9.23. As in Section 8, we first obtain sufficient conditions for a congruence ξ on \mathcal{J}_n to contain a Rees congruence R_q ; see Lemmas 9.18 and 9.22. The proof of the analogous result concerning the Brauer monoid \mathcal{B}_n , Lemma 8.13, relied on the fact that \mathcal{B}_n contains the symmetric group \mathcal{S}_n ; since \mathcal{J}_n does not contain \mathcal{S}_n , we will have to work harder to prove Lemmas 9.18 and 9.22. We begin with a simple result that will be of use on several occasions; its statement and proof do not assume n is odd.

Lemma 9.12. *Let $n \geq 3$ be arbitrary. Let $\alpha, \beta \in \mathcal{J}_n$ with $p = \text{rank}(\alpha) < q = \text{rank}(\beta)$. Suppose $\xi \in \text{Cong}(\mathcal{J}_n)$ is such that $R_p \subseteq \xi$ and $(\alpha, \beta) \in \xi$. Then $R_q \subseteq \xi$.*

Proof. Since $R_p \subseteq \xi$, it suffices to show that any Jones element $\gamma \in \mathcal{J}_n$ of rank at most q is ξ -related to an element of rank at most p . Since $\text{rank}(\gamma) \leq \text{rank}(\beta)$, it follows from Proposition 2.1(iv) that $\gamma = \delta_1\beta\delta_2$ for some $\delta_1, \delta_2 \in \mathcal{J}_n$. But then $\gamma = \delta_1\beta\delta_2 \xi \delta_1\alpha\delta_2$, and we are done, since $\text{rank}(\delta_1\alpha\delta_2) \leq \text{rank}(\alpha) = p$. \square

Lemma 9.13 (cf. Lemma 8.11). *Let $n \geq 3$ be odd. Suppose $\xi \in \text{Cong}(\mathcal{J}_n)$ and that $(\text{id}_n, \alpha) \in \xi$ for some $\alpha \in J_1$. Then $\xi = R_n$.*

Proof. By Lemma 9.12, it suffices to show that $R_1 \subseteq \xi$. Let A be a nontrivial $\text{coker}(\alpha)$ -class, and let $\beta \in J_1$ be such that A is not a $\text{coker}(\beta)$ -class. Then $(\beta, \beta\alpha) = (\beta \text{id}_n, \beta\alpha) \in \xi$. But $\text{rank}(\beta\alpha) = \text{rank}(\beta) = 1$, $\ker(\beta\alpha) = \ker(\beta)$, yet $\text{coker}(\beta\alpha) \neq \text{coker}(\beta)$, since A is a $\text{coker}(\beta\alpha)$ -class but not a $\text{coker}(\beta)$ -class. In particular, $(\beta, \beta\alpha) \in \rho_1 \setminus \Delta$, so Proposition 9.10 gives $\rho_1 = (\beta, \beta\alpha)^\sharp \subseteq \xi$. Similarly, $\lambda_1 \subseteq \xi$, and it follows from Proposition 3.27 that $R_1 = \rho_1 \vee \lambda_1 \subseteq \xi$, as required. \square

In what follows, we will make extensive use of the idempotents $\varepsilon_q = \begin{pmatrix} 1 & \cdots & q & | & q+1, q+2 & | & \cdots & | & n-1, n \\ 1 & \cdots & q & | & q+1, q+2 & | & \cdots & | & n-1, n \end{pmatrix}$, for $q = 1, 3, \dots, n$, already used in Section 8. We note that $\varepsilon_q \in \mathcal{J}_n$, and that $\varepsilon_q \mathcal{J}_n \varepsilon_q$ is a monoid with identity ε_q , isomorphic to \mathcal{J}_q .

Lemma 9.14. *Let $n \geq 3$ be odd. Suppose $\xi \in \text{Cong}(\mathcal{J}_n)$ and $(\alpha, \beta) \in \xi \cap (J_q \times J_1)$ with $q \geq 3$. Then $R_q \subseteq \xi$.*

Proof. Again, by Lemma 9.12, it suffices to show that $R_1 \subseteq \xi$. Write $\alpha = \left(\begin{array}{c|c|c|c} a_1 & \cdots & a_q & A_1 \cdots A_r \\ \cdots & \cdots & \cdots & \cdots \\ a_1 & \cdots & a_q & A_1 \cdots A_r \end{array} \right)$, with $a_1 < \cdots < a_q$, and define

$$\gamma_1 = \left(\begin{array}{c|c|c|c} 1 & \cdots & q & q+1, q+2 \cdots n-1, n \\ \cdots & \cdots & \cdots & \cdots \\ a_1 & \cdots & a_q & A_1 \cdots A_r \end{array} \right) \quad \text{and} \quad \gamma_2 = \left(\begin{array}{c|c|c|c} b_1 & \cdots & b_q & B_1 \cdots B_r \\ \cdots & \cdots & \cdots & \cdots \\ 1 & \cdots & q & q+1, q+2 \cdots n-1, n \end{array} \right).$$

For simplicity, write $\gamma = \gamma_1 \beta \gamma_2$. Then $\varepsilon_q = \gamma_1 \alpha \gamma_2 \xi \gamma_1 \beta \gamma_2 = \gamma$. But $\gamma \in \varepsilon_q \mathcal{J}_n \varepsilon_q$ and $\text{rank}(\gamma) = 1$. For $\sigma \in \varepsilon_q \mathcal{J}_n \varepsilon_q$, let $\sigma^\vee \in \mathcal{J}_q$ be the Jones element of degree q obtained from σ by removing the blocks $\{q+1, q+2\}, \dots, \{n-1, n\}$ and $\{(q+1)', (q+2)'\}, \dots, \{(n-1)', n'\}$. In \mathcal{J}_q , note that $(\varepsilon_q^\vee, \gamma^\vee) = (\text{id}_q, \gamma^\vee)$, with $\text{rank}(\gamma^\vee) = 1$, so by Lemma 9.13, this pair generates the universal congruence on \mathcal{J}_q . Since $(\varepsilon_q, \gamma) \in \xi$, it follows that all elements of $\varepsilon_q \mathcal{J}_n \varepsilon_q$ are ξ -related. In particular, choosing any pair of elements $\delta_3, \delta_4 \in \varepsilon_q \mathcal{J}_n \varepsilon_q$ such that $\text{rank}(\delta_3) = \text{rank}(\delta_4) = 1$, $\ker(\delta_3) \neq \ker(\delta_4)$ and $\text{coker}(\delta_3) \neq \text{coker}(\delta_4)$, Proposition 9.11 gives $R_1 = (\delta_3, \delta_4)^\# \subseteq \xi$. \square

Following [33], we say that an element a of a regular $*$ -semigroup S is a *projection* if $a^2 = a = a^*$. We denote the set of all projections of S by $\text{Proj}(S)$. It is well known that $\text{Proj}(S) = \{aa^* : a \in S\} = \{a^*a : a \in S\}$, and that for any $a \in \text{Proj}(S)$ and $x \in S$, $x^*ax \in \text{Proj}(S)$. By [12, Lemma 4], $\alpha \in \mathcal{J}_n$ is a projection if and only if it has the form $\alpha = \left(\begin{array}{c|c|c|c} a_1 & \cdots & a_q & A_1 \cdots A_r \\ \cdots & \cdots & \cdots & \cdots \\ a_1 & \cdots & a_q & A_1 \cdots A_r \end{array} \right)$. We do not assume n is odd for the statement or proof of the next result.

Lemma 9.15. *Let $n \geq 3$ be arbitrary. Suppose $\alpha \in \text{Proj}(\mathcal{J}_n)$ and $3 \leq \text{rank}(\alpha) \leq n-2$. Then there exists $\beta \in \text{Proj}(\mathcal{J}_n)$ with $\text{rank}(\alpha\beta) < \text{rank}(\alpha) = \text{rank}(\beta)$.*

Proof. Write $\alpha = \left(\begin{array}{c|c|c|c} a_1 & \cdots & a_q & A_1 \cdots A_r \\ \cdots & \cdots & \cdots & \cdots \\ a_1 & \cdots & a_q & A_1 \cdots A_r \end{array} \right)$, where $a_1 < \cdots < a_q$. There are three possibilities:

- (a) $a_1 = 1$ and $a_2 = 2$, (b) $a_1 = 1$ and $a_2 > 2$, or (c) $a_1 > 1$.

In case (a), we put $\beta = \left(\begin{array}{c|c|c|c} 3 & \cdots & q+2 & 1, 2 \mid q+3, q+4 \cdots n-1, n \\ \cdots & \cdots & \cdots & \cdots \\ 3 & \cdots & q+2 & 1, 2 \mid q+3, q+4 \cdots n-1, n \end{array} \right)$. In case (b), we assume without loss of generality that $A_1 = \{2, x\}$, and define $\beta = \left(\begin{array}{c|c|c|c} 1 & 2 & x & a_4 \cdots a_q \mid a_2, a_3 \mid A_2 \cdots A_r \\ \cdots & \cdots & \cdots & \cdots \\ 1 & 2 & x & a_4 \cdots a_q \mid a_2, a_3 \mid A_2 \cdots A_r \end{array} \right)$. In case (c), we assume that $A_1 = \{1, x\}$, and define $\beta = \left(\begin{array}{c|c|c|c} 1 & x & a_3 & \cdots \mid a_q \mid a_1, a_2 \mid A_2 \cdots A_r \\ \cdots & \cdots & \cdots & \cdots \\ 1 & x & a_3 & \cdots \mid a_q \mid a_1, a_2 \mid A_2 \cdots A_r \end{array} \right)$. \square

Remark 9.16. Of course the previous result does not hold for $\text{rank}(\alpha) \leq 1$, since the set of Jones elements of rank at most 1 is closed under multiplication. It does not hold for $\text{rank}(\alpha) = 2$ either, although it *almost* does. We do not need to know this, but it can be proved (see Remark 9.21) that the only exception is $\alpha = \left(\begin{array}{c|c|c|c} 1 & n & 2, 3 & \cdots \mid n-2, n-1 \\ \cdots & \cdots & \cdots & \cdots \\ 1 & n & 2, 3 & \cdots \mid n-2, n-1 \end{array} \right)$: for now, it is easy to check that $\text{rank}(\alpha\beta) = 2$ for any projection $\beta \in \text{Proj}(\mathcal{J}_n)$ with $\text{rank}(\beta) = 2$.

Consider a projection $\alpha = \left(\begin{array}{c|c|c|c} a_1 & \cdots & a_q & A_1 \cdots A_r \\ \cdots & \cdots & \cdots & \cdots \\ a_1 & \cdots & a_q & A_1 \cdots A_r \end{array} \right) \in \text{Proj}(\mathcal{J}_n)$, where $a_1 < \cdots < a_q$. The set $\alpha \mathcal{J}_n \alpha$, consisting of all Jones elements containing the blocks A_i and A'_i for each $1 \leq i \leq r$, is a subsemigroup of \mathcal{J}_n isomorphic to \mathcal{J}_q ; the identity element of $\alpha \mathcal{J}_n \alpha$ is α . We have already made use of this fact in the special case that $\alpha = \varepsilon_q$.

Lemma 9.17 (cf. Lemma 8.12). *Let $n \geq 3$ be odd. Suppose $\xi \in \text{Cong}(\mathcal{J}_n)$ and that $(\text{id}_n, \alpha) \in \xi$ for some $\alpha \in \mathcal{J}_n$ with $\text{rank}(\alpha) < n$. Then $\xi = R_n$.*

Proof. We proceed by induction on n . The result is true for $n = 3$ by Lemma 9.13, so suppose $n \geq 5$. Write $q = \text{rank}(\alpha)$. If $q = 1$, then we are also done by Lemma 9.13, so suppose $q \geq 3$. First note that $\text{id}_n \xi \alpha = \alpha \alpha^* \alpha \xi \alpha \alpha^* \text{id}_n = \alpha \alpha^*$, so that id_n is ξ -related to a projection of rank q . As such, from this point on, we may assume without loss of generality that α is itself a projection (of rank $q \geq 3$).

By Lemma 9.15, we may fix a projection $\beta \in \text{Proj}(\mathcal{J}_n)$ with $\text{rank}(\beta) = q$ and $\text{rank}(\alpha\beta) < q$. Write $\beta = \left(\begin{array}{c|c|c|c} a_1 & \cdots & a_q & A_1 \cdots A_r \\ \cdots & \cdots & \cdots & \cdots \\ a_1 & \cdots & a_q & A_1 \cdots A_r \end{array} \right)$, where $a_1 < \cdots < a_r$. As noted above, $\beta \mathcal{J}_n \beta$ is a subsemigroup of \mathcal{J}_n isomorphic to \mathcal{J}_q , and has β as its identity element. For $\sigma \in \beta \mathcal{J}_n \beta$, we write σ^\vee for the element of \mathcal{J}_q obtained from σ by removing the blocks A_i, A'_i ($1 \leq i \leq r$), and renaming the elements of the remaining blocks via the bijection $\text{dom}(\beta) \rightarrow \mathbf{q} : a_i \mapsto i$. So $\beta \mathcal{J}_n \beta \rightarrow \mathcal{J}_q : \sigma \mapsto \sigma^\vee$ is an isomorphism.

Now, $\beta = \beta\beta = \beta \text{id}_n \beta \xi \beta\alpha\beta$, and we note that $\beta, \beta\alpha\beta \in \beta\mathcal{J}_n\beta$ and $\text{rank}(\beta\alpha\beta) \leq \text{rank}(\alpha\beta) < q = \text{rank}(\beta)$. It follows that $\beta^\vee = \text{id}_q$ and $(\beta\alpha\beta)^\vee \in \mathcal{J}_q$ with $\text{rank}((\beta\alpha\beta)^\vee) < q$. By induction, it follows that the pair $(\beta^\vee, (\beta\alpha\beta)^\vee)$ generates the universal congruence on \mathcal{J}_q . Since $(\beta, \beta\alpha\beta) \in \xi$, as noted above, it follows that all elements of $\beta\mathcal{J}_n\beta$ are ξ -related. In particular, $(\beta, \beta\varepsilon_1\beta) \in \xi$. Since $\text{rank}(\beta) = q \geq 3$ and $\text{rank}(\beta\varepsilon_1\beta) = 1$, Lemma 9.14 gives $R_q \subseteq \xi$. Together with the fact that $(\text{id}_n, \alpha) \in \xi$ and $\text{rank}(\alpha) = q$, Lemma 9.12 then gives $R_n \subseteq \xi$, whence $\xi = R_n$. \square

The proof of the next result is almost identical to that of Lemma 9.14, but relies on Lemma 9.17 instead of Lemma 9.13.

Lemma 9.18 (cf. Lemma 8.13). *Let $n \geq 3$ be odd. Suppose $\xi \in \text{Cong}(\mathcal{J}_n)$ and that there exists $(\alpha, \beta) \in \xi$ with $q = \text{rank}(\alpha) \geq 3$ and $\text{rank}(\beta) < q$. Then $R_q \subseteq \xi$.* \square

For the proof of the next lemma, if a and b are non-negative integers, and if $\alpha \in \mathcal{J}_a$ and $\beta \in \mathcal{J}_b$, we write $\alpha \oplus \beta$ for the element of \mathcal{J}_{a+b} obtained by placing β to the right of α . Formally, we rename elements of each block of $\beta \in \mathcal{J}_b$ via the bijection $[1, b] \rightarrow [a+1, a+b] : i \mapsto a+i$, and then $\alpha \oplus \beta$ consists of all these modified blocks plus the (unmodified) blocks of α . Note that, by convention, we consider \mathcal{J}_0 to consist of a single element: namely, the *empty partition* \emptyset . If a is any non-negative integer and $\alpha \in \mathcal{J}_a$, then $\alpha \oplus \emptyset = \emptyset \oplus \alpha = \alpha$. An extension of this operation has been used to give *diagram categories* such as the Brauer and Temperley-Lieb categories (*strict*) *monoidal* structures; see for example [22, 29]. The \oplus operation was also used to classify and enumerate the idempotents in the partition and (partial) Brauer monoids in [7].

For the statement of the next result, we do not assume n is odd, but the proof makes use of the fact that it holds for even n , and indicates why this is the case.

Lemma 9.19. *Let $n \geq 3$ be arbitrary. Suppose $\alpha, \beta \in \text{Proj}(\mathcal{J}_n)$ are such that $\alpha \neq \beta$ and $2 \leq \text{rank}(\alpha) = \text{rank}(\beta) \leq n-2$. Then, renaming α, β if necessary, there exists $\gamma \in \text{Proj}(\mathcal{J}_n)$ such that $\text{rank}(\alpha\gamma) < \text{rank}(\beta\gamma) = \text{rank}(\alpha) = \text{rank}(\gamma)$.*

Proof. The result is true for even n , because of Lemma 7.8 (cf. Lemma 5.13), where the constructed element γ is indeed a projection, and the isomorphism $\mathcal{PP}_m \rightarrow \mathcal{J}_{2m} : \alpha \mapsto \tilde{\alpha}$, keeping in mind the fact that $\text{rank}(\tilde{\alpha}) = 2\text{rank}(\alpha)$ for any $\alpha \in \mathcal{PP}_m$. So we assume n is odd for the rest of the proof. This also forces $\text{rank}(\alpha) = \text{rank}(\beta) \geq 3$ to be odd. Write $\alpha = \left(\begin{array}{c|c|c|c} a_1 & \cdots & a_q & A_1 \cdots A_r \\ \hline a_1 & \cdots & a_q & A_1 \cdots A_r \end{array} \right)$ and $\beta = \left(\begin{array}{c|c|c|c} b_1 & \cdots & b_q & B_1 \cdots B_r \\ \hline b_1 & \cdots & b_q & B_1 \cdots B_r \end{array} \right)$, where $a_1 < \cdots < a_q$ and $b_1 < \cdots < b_q$.

Case 1. Suppose first that $a_1 = b_1$ and $a_2 = b_2$. We may write $\alpha = \alpha_1 \oplus \text{id}_1 \oplus \alpha_2 \oplus \text{id}_1 \oplus \alpha_3$ and $\beta = \beta_1 \oplus \text{id}_1 \oplus \beta_2 \oplus \text{id}_1 \oplus \beta_3$, where $\alpha_1, \beta_1 \in \text{Proj}(\mathcal{J}_{a_1-1})$, $\alpha_2, \beta_2 \in \text{Proj}(\mathcal{J}_{a_2-a_1-1})$ and $\alpha_3, \beta_3 \in \text{Proj}(\mathcal{J}_{n-a_2})$. Note that $\text{rank}(\alpha_1) = \text{rank}(\beta_1) = \text{rank}(\alpha_2) = \text{rank}(\beta_2) = 0$ and $\text{rank}(\alpha_3) = \text{rank}(\beta_3) = q-2 \geq 1$.

Subcase 1.1. Suppose $\alpha_1 \neq \beta_1$, and write $\alpha_4 = \alpha_1 \oplus \text{id}_1 \oplus \alpha_2 \oplus \text{id}_1$ and $\beta_4 = \beta_1 \oplus \text{id}_1 \oplus \beta_2 \oplus \text{id}_1$. Then $\alpha_4, \beta_4 \in \text{Proj}(\mathcal{J}_{a_2})$, $\text{rank}(\alpha_4) = \text{rank}(\beta_4) = 2$ and $\alpha_4 \neq \beta_4$. Since a_2 is even, and since the lemma holds for even n , there exists $\delta \in \text{Proj}(\mathcal{J}_{a_2})$ such that, renaming if necessary, $\text{rank}(\alpha_4\delta) < \text{rank}(\beta_4\delta) = \text{rank}(\delta) = 2$. It is then easy to check that $\gamma = \delta \oplus \beta_3$ has the desired properties.

Subcase 1.2. Suppose $\alpha_1 = \beta_1$, and write $\alpha_5 = \alpha_2 \oplus \text{id}_1 \oplus \alpha_3$ and $\beta_5 = \beta_2 \oplus \text{id}_1 \oplus \beta_3$. This time we have $\alpha_5, \beta_5 \in \text{Proj}(\mathcal{J}_{n-a_1})$, with $n-a_1$ even, and with all the hypotheses of the lemma satisfied by α_5, β_5 . The proof concludes in similar fashion to Subcase 1.1: we find a suitable $\delta \in \text{Proj}(\mathcal{J}_{n-a_1})$ and put $\gamma = \beta_1 \oplus \text{id}_1 \oplus \delta$.

Case 2. Next suppose $a_1 = b_1$ but $a_2 \neq b_2$. We may write $\alpha = \alpha_1 \oplus \text{id}_1 \oplus \alpha_2$ and $\beta = \beta_1 \oplus \text{id}_1 \oplus \beta_2$, where $\alpha_1, \beta_1 \in \text{Proj}(\mathcal{J}_{a_1-1})$ and $\alpha_2, \beta_2 \in \text{Proj}(\mathcal{J}_{n-a_1})$. Since $a_2 \neq b_2$, we know that $\alpha_2 \neq \beta_2$. So, by the even version of the lemma, and renaming if necessary, there exists $\delta \in \text{Proj}(\mathcal{J}_{n-a_1})$ such that $\text{rank}(\alpha_2\delta) < \text{rank}(\beta_2\delta) = \text{rank}(\delta) = q-1$, and we put $\gamma = \beta_1 \oplus \text{id}_1 \oplus \delta$.

Case 3. Next suppose $a_1 \neq b_1$ but $a_2 = b_2$. We may write $\alpha = \alpha_1 \oplus \text{id}_1 \oplus \alpha_2$ and $\beta = \beta_1 \oplus \text{id}_1 \oplus \beta_2$, where $\alpha_1, \beta_1 \in \text{Proj}(\mathcal{J}_{a_2-1})$, $\alpha_2, \beta_2 \in \text{Proj}(\mathcal{J}_{n-a_2})$. Since $a_1 \neq b_1$, $\alpha_1 \oplus \text{id}_1$ and $\beta_1 \oplus \text{id}_1$ are distinct projections of rank 2 from \mathcal{J}_{a_2} , and the proof concludes in similar fashion to Case 2.

Case 4. Finally, suppose $a_1 \neq b_1$ and $a_2 \neq b_2$. Without loss of generality, we may assume that $a_1 < b_1$. If $b_2 < a_2$, then we let γ be any projection with $\text{dom}(\gamma) = \text{dom}(\alpha)$ and containing the block $\{b_1, b_2\}$. If

$a_2 < b_1$, then we let γ be any projection with $\text{dom}(\gamma) = \text{dom}(\beta)$ and containing the block $\{a_1, a_2\}$. Since $a_1 < b_1$, $a_2 \neq b_2$ and $a_2 \neq b_1$ (the latter because b_1, a_2 have opposite parities), the only remaining possibility is $a_1 < b_1 < a_2 < b_2$; we assume this is the case for the remainder of the proof. For each $i \in \{1, 2\}$, let the $\text{coker}(\beta)$ -class of a_i be $\{a_i, x_i\}$ and the $\text{coker}(\alpha)$ -class of b_i be $\{b_i, y_i\}$. If $x_1 > a_1$, then we let γ be any projection with $\text{dom}(\gamma) = \{a_1, x_1, a_3, \dots, a_q\}$. If $x_2 < a_2$, then we let γ be any projection with $\text{dom}(\gamma) = \{x_2, a_2, a_3, \dots, a_q\}$. The cases in which $y_1 > b_1$ or $y_2 < b_2$ are treated in similar fashion. So suppose instead that $x_1 < a_1$, $x_2 > a_2$, $y_1 < b_1$ and $y_2 > b_2$. Since also $y_1 > a_1$ (by planarity of α) and $x_2 < b_2$ (by planarity of β), it follows that

$$x_1 < a_1 < y_1 < b_1 < a_2 < x_2 < b_2 < y_2.$$

Note that if $\text{rank}(\alpha\beta) < q$, then we may simply take $\gamma = \beta$. So we assume that $\text{rank}(\alpha\beta) = q$. In particular, $\text{dom}(\alpha\beta) = \text{dom}(\alpha)$ and $\text{codom}(\alpha\beta) = \text{codom}(\beta)$. Consider the product graph $\Pi(\alpha, \beta)$. Since $a_1 = \min(\text{dom}(\alpha\beta))$ and $b_1 = \min(\text{codom}(\alpha\beta))$, there is a path P in $\Pi(\alpha, \beta)$ from a_1 to b'_1 . By the above discussion, we know the first two and last two edges the path P uses:

$$a_1 \xrightarrow{\alpha} a''_1 \xrightarrow{\beta} x''_1 \xrightarrow{\alpha} \dots \xrightarrow{\beta} y''_1 \xrightarrow{\alpha} b''_1 \xrightarrow{\beta} b'_1,$$

with all edges other the first and last connecting vertices from \mathbf{n}'' . (Here, for example, we have written $u \xrightarrow{\alpha} v$ to indicate that the edge $\{u, v\}$ from $\Pi(\alpha, \beta)$ comes from α .) Note that for any edge $i'' \xrightarrow{\alpha} j''$ or $k'' \xrightarrow{\beta} l''$ in P , i, l are even, and j, k odd. Let w be the minimal element of \mathbf{n} such that the path P visits vertex w'' . So $w \leq x_1 < a_1$. We claim that w is odd. Indeed, since $w < a_1 < b_1$, the path P contains edges

$$(i) \quad i'' \xrightarrow{\alpha} w'' \xrightarrow{\beta} j'' \text{ for some } i, j, \quad \text{or} \quad (ii) \quad i'' \xrightarrow{\beta} w'' \xrightarrow{\alpha} j'' \text{ for some } i, j.$$

Keeping in mind the above note concerning the parity of endpoints of edges in P , to prove the claim that w is odd, it suffices to show that (i) is the case. In order to do this, consider the product graph $\Pi(\alpha, \beta)$ embedded in the plane \mathbb{R}^2 as follows. For each $i \in \mathbf{n}$, we identify the vertices i, i'', i' with the points $(i, n), (i, 0), (i, -n)$ respectively. Define the rectangle $\mathfrak{R} = \{(x, y) \in \mathbb{R}^2 : 1 \leq x \leq n, -n \leq y \leq n\}$ to be the convex hull of these $3n$ points, and add edges from α and β such that:

- each transverse edge of α or β is drawn as a vertical line segment connecting its endpoints, and
- each non-transverse edge is drawn as a semicircle within \mathfrak{R} , above or below the line $y = 0$ depending on whether the edge belongs to α or β , respectively.

So $\Pi(\alpha, \beta)$, embedded in \mathbb{R}^2 as above, contains a smooth planar curve \mathcal{C} , induced by the path P , connecting a_1 (on the upper edge of the rectangle \mathfrak{R}) to b'_1 (on the lower edge of \mathfrak{R}). Let \mathcal{C}_1 be the portion of this curve joining a_1 to w'' , and \mathcal{C}_2 the portion joining w'' to b'_1 . Note that \mathcal{C} is contained in the smaller rectangle $\mathfrak{R}_1 = \{(x, y) \in \mathbb{R}^2 : w \leq x \leq n, -n \leq y \leq n\}$. A schematic diagram of all this is given in Figure 12.

Since \mathcal{C}_1 is contained in \mathfrak{R}_1 , and joins a_1 (on the upper side of \mathfrak{R}_1) to w'' (on the left side of \mathfrak{R}_1), \mathcal{C}_1 splits \mathfrak{R}_1 into two regions: \mathfrak{R}_1^+ , containing the vertex w (the upper left corner of \mathfrak{R}_1), and \mathfrak{R}_1^- , containing the vertex n' (the lower right corner of \mathfrak{R}_1). (Note that P does not visit the point n'' , since $\Pi(a, b)$ also contains a path from a_2 to b'_2 .) Now, \mathcal{C}_2 is contained in \mathfrak{R}_1 and, apart from its initial vertex w'' , never intersects \mathcal{C}_1 , so $\mathcal{C}_2 \setminus \{w''\}$ is contained in one of \mathfrak{R}_1^+ or \mathfrak{R}_1^- . But \mathcal{C}_2 connects w'' to b'_1 , with the latter point belonging to \mathfrak{R}_1^- . So it follows that $\mathcal{C}_2 \setminus \{w''\}$ is contained in \mathfrak{R}_1^- . Recall that \mathcal{C}_1 and \mathcal{C}_2 are unions of edges from the product graph $\Pi(\alpha, \beta)$. Let E_1 be the last such edge in \mathcal{C}_1 , and E_2 the first such edge in \mathcal{C}_2 . So E_1 is of the form $i'' \rightarrow w''$, and E_2 is of the form $w'' \rightarrow j''$, for some $i, j \in \mathbf{n}$. If E_1 belonged to β , then E_2 would belong to α ; but then at least a segment of E_2 (for $w < x < w + 1/2$, say) would lie above the corresponding segment of E_1 , so that \mathcal{C}_2 contained points in \mathfrak{R}_1^+ , a contradiction. Hence, E_1 belongs to α . This completes the proof that (i) holds and, hence, that w is odd.

Since the first edge of the path P is $a_1 \xrightarrow{\alpha} a''_1$, the edge immediately preceding those listed above in (i) must be of the form $k'' \xrightarrow{\beta} i''$ for some k . To summarise, we know that $\Pi(\alpha, \beta)$ contains the edges

$$k'' \xrightarrow{\beta} i'' \xrightarrow{\alpha} w'' \xrightarrow{\beta} j'' \quad \text{for some } i, j, k > w.$$

In particular, $\{k, i\}$ and $\{w, j\}$ are $\text{coker}(\beta)$ -classes, and $\{i, w\}$ is a $\text{coker}(\alpha)$ -class. By planarity, and keeping in mind that $w < i, j, k$, we must be in one of the following four cases:

- (a) $w < k < i < j$, (b) $w < i < k < j$, (c) $w < j < k < i$, or (d) $w < j < i < k$.

Since $w < a_1 < b_1$, planarity also implies that $i < a_1$, $j < b_1$ and $k < b_1$. In cases (a) and (b), we define γ to be any projection with domain $\{w, i, b_3, \dots, b_q\}$ and containing the block $\{j, b_1\}$. In cases (c) and (d), we define γ to be any projection with domain $\{w, j, a_3, \dots, a_q\}$ and containing the block $\{i, a_1\}$. This completes the proof. \square

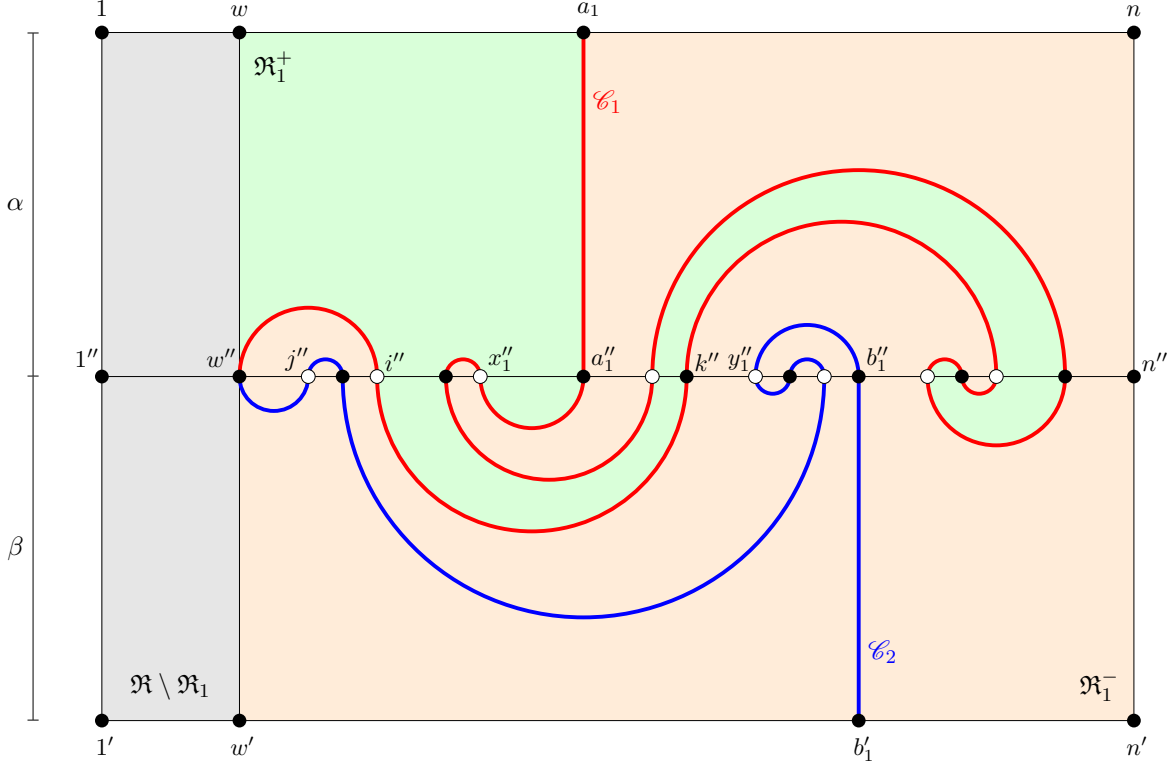

Figure 12: The curve $\mathcal{C} = \mathcal{C}_1 \cup \mathcal{C}_2$ from Case 4 of the proof of Lemma 9.19. The curves \mathcal{C}_1 and \mathcal{C}_2 are drawn red and blue, respectively. The regions \mathfrak{R}_1^+ and \mathfrak{R}_1^- are shaded green and orange, respectively, and the region $\mathfrak{R} \setminus \mathfrak{R}_1$ is shaded gray. Odd-labelled vertices are drawn black, and even-labelled vertices white.

Remark 9.20. In Figure 12, we have $w < j < i < k$, so we are in case (d), as enumerated at the end of the previous proof. The reader might like to construct the projections α, β, γ in this case.

Remark 9.21. We also note that Lemma 9.19 has another interpretation. Fix some $2 \leq q \leq n-2$, and fix an ordering on the set $\{\alpha_1, \dots, \alpha_k\}$ of all projections from the \mathcal{J} -class J_q . (By the proof of [13, Theorem 9.5], we have $k = \frac{q+1}{n+1} \binom{n+1}{(n-q)/2}$.) Define a $k \times k$ matrix $M = (m_{ij})$ with entries in $\{0, 1\}$, where $m_{ij} = 1$ if and only if the unique element $\alpha \in J_q$ satisfying $\alpha_i \mathcal{R} \alpha \mathcal{L} \alpha_j$ is an idempotent. (We note that M is the *sandwich matrix* for the representation of the principal factor of \overline{J}_q as a Rees matrix semigroup; see [19, Section 3.2].) By [8, Lemma 2.3(ii)], we also have $m_{ij} = 1$ if and only if $\text{rank}(\alpha_i \alpha_j) = q$. Thus, Lemma 9.19 says that no two rows of the matrix M are equal. Note that this is also vacuously true for $q = n$, but not true for $q \leq 1$, as all Jones (or even Brauer) elements of minimal rank are idempotents. Similarly, Lemma 9.15 may be interpreted as saying that if $3 \leq q \leq n-2$, then every row of the matrix M has at least one entry equal to 0. Remark 9.16 asserts that when $q = 2$, the matrix M has exactly one row with no entries equal to 0. This can now be seen to be true. Indeed, it is easy to check, when $q = 2$, that one row of M has no entries equal to 0 (the exact row was specified in Remark 9.16). The fact that this row is unique follows from the reinterpreted version of Lemma 9.19.

Lemma 9.22. *Suppose $\xi \in \text{Cong}(\mathcal{J}_n)$ and $(\alpha, \beta) \in (\xi \setminus \Delta) \cap (J_q \times J_q)$ with $q \geq 3$. Then $R_q \subseteq \xi$.*

Proof. Since $\alpha \neq \beta$, we have either $(\alpha, \beta) \notin \mathcal{R}$ or $(\alpha, \beta) \notin \mathcal{L}$. By symmetry, we may assume the latter is the case. Note that $\alpha^* \alpha$ and $\beta^* \beta$ are distinct projections of rank q , since $\alpha^* \alpha \mathcal{L} \alpha$ and $\beta^* \beta \mathcal{L} \beta$. So, by Lemma 9.19, there exists $\gamma \in \text{Proj}(\mathcal{J}_n)$ such that, renaming α, β if necessary, $\text{rank}(\alpha^* \alpha \gamma) < q$ and

$\text{rank}(\beta^*\beta\gamma) = q$. Now, $\alpha\gamma = \alpha(\alpha^*\alpha\gamma)$, so it follows that $\alpha\gamma \mathcal{L} \alpha^*\alpha\gamma$. Consequently, $\alpha\gamma \not\mathcal{J} \alpha^*\alpha\gamma$, whence $\text{rank}(\alpha\gamma) = \text{rank}(\alpha^*\alpha\gamma) < q$. Similarly, $\text{rank}(\beta\gamma) = \text{rank}(\beta^*\beta\gamma) = q$. Since $(\alpha\gamma, \beta\gamma) \in \xi$, Lemma 9.18 then gives $R_q \subseteq \xi$. \square

Armed with the previous results, we may now characterise the generating pairs for the Rees congruences R_q , for $q \geq 3$.

Proposition 9.23. *Let n be odd, and suppose $3 \leq q \leq n$ is odd. Then R_q is a principal congruence on \mathcal{J}_n . Moreover, if $\alpha, \beta \in \mathcal{J}_n$, then $R_q = (\alpha, \beta)^\sharp \Leftrightarrow (\alpha, \beta) \in R_q \setminus R_{q-2}$.*

Proof. Let $(\alpha, \beta) \in R_q \setminus R_{q-2}$. The proof will be complete if we can show that $R_q \subseteq (\alpha, \beta)^\sharp$. Renaming α, β if necessary, we may assume that $\text{rank}(\alpha) = q$. But then $R_q \subseteq (\alpha, \beta)^\sharp$ follows from Lemma 9.18 if $\text{rank}(\beta) < q$, or from Lemma 9.22 if $\text{rank}(\beta) = q$. \square

We now have all we need to conclude the proof.

Proof of Theorem 9.1 for n odd. As usual, the proof is completed by verifying that in describing the generating pairs of the congruences R_q (Propositions 9.11 and 9.23) and λ_1, ρ_1 (Proposition 9.10), we have covered all possible pairs of distinct elements of \mathcal{J}_n . \square

Acknowledgements

This work was initiated during a visit of the first author to the other three in 2016; he thanks the University of St Andrews for its hospitality during his stay.

References

- [1] The on-line encyclopedia of integer sequences. Published electronically at <http://oeis.org/>.
- [2] A. J. Aizenštát. On homomorphisms of semigroups of endomorphisms of ordered sets. *Leningrad. Gos. Ped. Inst. Učen. Zap.*, 238:38–48, 1962.
- [3] J. Araújo, W. Bentz, and G. Gomes. Congruences on direct products of transformation and matrix monoids. *Preprint*, 2016, [arXiv:1602.06339](https://arxiv.org/abs/1602.06339).
- [4] G. Benkart and T. Halverson. Motzkin algebras. *European J. Combin.*, 36:473–502, 2014.
- [5] M. Borisavljević, K. Došen, and Z. Petrić. Kauffman monoids. *J. Knot Theory Ramifications*, 11(2):127–143, 2002.
- [6] R. Brauer. On algebras which are connected with the semisimple continuous groups. *Ann. of Math. (2)*, 38(4):857–872, 1937.
- [7] I. Dolinka, J. East, A. Evangelou, D. FitzGerald, N. Ham, J. Hyde, and N. Loughlin. Enumeration of idempotents in diagram semigroups and algebras. *J. Combin. Theory Ser. A*, 131:119–152, 2015.
- [8] I. Dolinka, J. East, A. Evangelou, D. FitzGerald, N. Ham, J. Hyde, N. Loughlin, and J. D. Mitchell. Enumeration of idempotents in the Jones, Motzkin and Kauffman monoids. In preparation.
- [9] I. Dolinka, J. East, and R. D. Gray. Motzkin monoids and partial Brauer monoids. *J. Algebra*, 471:251–298, 2017.
- [10] J. East. Generators and relations for partition monoids and algebras. *J. Algebra*, 339:1–26, 2011.
- [11] J. East. On the singular part of the partition monoid. *Internat. J. Algebra Comput.*, 21(1-2):147–178, 2011.
- [12] J. East and D. G. FitzGerald. The semigroup generated by the idempotents of a partition monoid. *J. Algebra*, 372:108–133, 2012.
- [13] J. East and R. D. Gray. Diagram monoids and Graham–Houghton graphs: Idempotents and generating sets of ideals. *J. Combin. Theory Ser. A*, 146:63–128, 2017.
- [14] V. H. Fernandes. The monoid of all injective order preserving partial transformations on a finite chain. *Semigroup Forum*, 62(2):178–204, 2001.
- [15] D. G. FitzGerald and K. W. Lau. On the partition monoid and some related semigroups. *Bull. Aust. Math. Soc.*, 83(2):273–288, 2011.
- [16] O. Ganyushkin and V. Mazorchuk. *Classical finite transformation semigroups, an introduction*, volume 9 of *Algebra and Applications*. Springer-Verlag London, Ltd., London, 2009.
- [17] T. Halverson and A. Ram. Partition algebras. *European J. Combin.*, 26(6):869–921, 2005.
- [18] K. Hatch, M. Ly, and E. Posner. Presentation of the Motzkin monoid. *Preprint*, 2013, [arXiv:1301.4518](https://arxiv.org/abs/1301.4518).
- [19] J. M. Howie. *Fundamentals of semigroup theory*, volume 12 of *London Mathematical Society Monographs. New Series*. The Clarendon Press, Oxford University Press, New York, 1995. Oxford Science Publications.
- [20] V. F. R. Jones. The Potts model and the symmetric group. In *Subfactors (Kyuzeso, 1993)*, pages 259–267. World Sci. Publ., River Edge, NJ, 1994.
- [21] K. W. Lau and D. G. FitzGerald. Ideal structure of the Kauffman and related monoids. *Comm. Algebra*, 34(7):2617–2629, 2006.
- [22] G. Lehrer and R. B. Zhang. The Brauer category and invariant theory. *J. Eur. Math. Soc. (JEMS)*, 17(9):2311–2351, 2015.
- [23] A. E. Liber. On symmetric generalized groups. *Mat. Sbornik N.S.*, 33(75):531–544, 1953.

- [24] A. I. Mal'cev. Symmetric groupoids (Russian). *Mat. Sbornik N.S.*, 31(73):136–151, 1952. English translation in Twelve papers in logic and algebra, Amer. Math. Soc. Translations Ser 2 **113**, AMS, 1979, pp. 235–250.
- [25] A. I. Mal'cev. Multiplicative congruences of matrices. *Doklady Akad. Nauk SSSR (N.S.)*, 90:333–335, 1953.
- [26] V. Maltcev and V. Mazorchuk. Presentation of the singular part of the Brauer monoid. *Math. Bohem.*, 132(3):297–323, 2007.
- [27] M. P. O. Marques-Smith and R. P. Sullivan. The congruences on the semigroup of balanced transformations of an infinite set. *J. Algebra*, 234(1):1–30, 2000.
- [28] P. Martin. Temperley-Lieb algebras for nonplanar statistical mechanics—the partition algebra construction. *J. Knot Theory Ramifications*, 3(1):51–82, 1994.
- [29] P. Martin. Diagram categories, representation theory, statistical mechanics. In *Noncommutative rings, group rings, diagram algebras and their applications*, volume 456 of *Contemp. Math.*, pages 99–136. Amer. Math. Soc., Providence, RI, 2008.
- [30] P. Martin and V. Mazorchuk. On the representation theory of partial Brauer algebras. *Q. J. Math.*, 65(1):225–247, 2014.
- [31] V. Mazorchuk. On the structure of Brauer semigroup and its partial analogue. *Problems in Algebra*, 13:29–45, 1998.
- [32] J. D. Mitchell et al. *Semigroups - GAP package, Version 3.0.5*, Aug 2017.
- [33] T. E. Nordahl and H. E. Scheiblich. Regular $*$ -semigroups. *Semigroup Forum*, 16(3):369–377, 1978.
- [34] J. Rhodes and B. Steinberg. *The q -theory of finite semigroups*. Springer Monographs in Mathematics. Springer, New York, 2009.
- [35] È. G. Šutov. Homomorphisms of the semigroup of all partial transformations. *Izv. Vysš. Učebn. Zaved. Matematika*, 1961(3(22)):177–184, 1961.
- [36] È. G. Šutov. Semigroups of one-to-one transformations. *Dokl. Akad. Nauk SSSR*, 140:1026–1028, 1961.
- [37] H. N. V. Temperley and E. H. Lieb. Relations between the “percolation” and “colouring” problem and other graph-theoretical problems associated with regular planar lattices: some exact results for the “percolation” problem. *Proc. Roy. Soc. London Ser. A*, 322(1549):251–280, 1971.
- [38] S. Wilcox. Cellularity of diagram algebras as twisted semigroup algebras. *J. Algebra*, 309(1):10–31, 2007.