

Diss. ETH No. 14335

# **A Graph Theoretical Approach for Reconstruction and Generation of Oriented Matroids**

A dissertation submitted to the  
SWISS FEDERAL INSTITUTE OF TECHNOLOGY  
ZURICH

for the degree of  
DOCTOR OF MATHEMATICS

presented by

LUKAS FINSCHI  
dipl. Math. ETH

born 1972 March 18  
citizen of Safien GR

accepted on the recommendation of

Prof. Hans-Jakob Lüthi, examiner  
Prof. Komei Fukuda, co-examiner  
Prof. Günter M. Ziegler, co-examiner

2001



# Contents

<b>Acknowledgements</b>	<b>xiii</b>
<b>Abstract</b>	<b>xv</b>
<b>Zusammenfassung</b>	<b>xvii</b>
<b>Structure Diagram</b>	<b>xix</b>
<b>0 Introduction</b>	<b>1</b>
<b>Motivation and Overview</b>	<b>3</b>
<b>0 An Introduction to Oriented Matroids</b>	<b>15</b>
0.1 A First Tour of Oriented Matroids . . . . .	15
0.2 Covector Axioms . . . . .	21
0.3 Matroids . . . . .	23
0.4 Minors . . . . .	28
0.5 Duality . . . . .	32
0.6 Cocircuits . . . . .	37
0.7 Topes and the Big Face Lattice . . . . .	41
0.8 Oriented Matroid Programming . . . . .	46
0.9 Basis Orientations and Chirotopes . . . . .	48

<b>I</b>	<b>Reconstruction</b>	<b>53</b>
<b>1</b>	<b>Topes and Tope Graphs</b>	<b>55</b>
1.1	Introduction and Problem Statements . . . . .	55
1.2	Properties of Topes Graphs . . . . .	58
1.3	Separability of Uncut Topes . . . . .	61
1.4	Orientation Reconstruction . . . . .	66
1.5	Face Reconstruction from Topes . . . . .	68
1.6	Construction of Covectors and Topes from Cocircuits . . . . .	71
1.7	Algorithmic Characterization of Tope Sets . . . . .	72
<b>2</b>	<b>Cocircuits and Cocircuit Graphs</b>	<b>75</b>
2.1	Introduction and Problem Statements . . . . .	75
2.2	Orientation Reconstruction from Matroid Label . . . . .	78
2.3	Reconstruction of Uniform Matroid Labels from Antipodes . . . . .	82
2.4	Antipodes in Uniform Cocircuit Graphs . . . . .	86
2.5	Characterization of Cocircuit Graphs . . . . .	89
2.6	Open Problems . . . . .	90
<b>II</b>	<b>Generation</b>	<b>93</b>
<b>3</b>	<b>Generation of Oriented Matroids and Isomorphism Classes</b>	<b>95</b>
3.1	Introduction . . . . .	95
3.2	Duality and the Generation of Isomorphism Classes . . . . .	96
3.3	Incremental Method for the Generation of Isomorphism Classes . . . . .	99
3.4	Graph Representations in Generation Methods . . . . .	102
<b>4</b>	<b>Tope Graphs and Single Element Extensions</b>	<b>105</b>
4.1	Tope Graphs and Isomorphism Classes of Oriented Matroids . . . . .	105
4.2	Localizations and Tope Graph Extensions . . . . .	107
4.3	Reverse Search Method for the Generation of Localizations . . . . .	111

4.4	Reduction of Multiple Extension Using Isomorphic Signatures . . . . .	113
4.5	Reduction of Multiple Extension Using Maximal Localizations . . . . .	115
<b>5</b>	<b>Cocircuit Graphs and Single Element Extensions</b>	<b>117</b>
5.1	Cocircuit Graphs and Isomorphism Classes of Oriented Matroids . . . . .	117
5.2	Localizations and Cocircuit Graph Extensions . . . . .	120
5.3	Two Methods for the Generation of Localizations . . . . .	125
5.4	Backtracking Method for the Generation of Localizations . . . . .	126
<b>III</b>	<b>Applications</b>	<b>131</b>
<b>6</b>	<b>A Catalog of Oriented Matroids</b>	<b>133</b>
6.1	Introduction . . . . .	133
6.2	Organization of Catalog . . . . .	134
6.3	Properties of Catalog . . . . .	136
6.4	Generation of Catalog . . . . .	138
6.5	Overview of Results . . . . .	141
6.6	Access to Catalog and Examples . . . . .	144
<b>7</b>	<b>Complete Listing of Point Configurations</b>	<b>147</b>
7.1	Introduction . . . . .	147
7.2	Point Configurations and Acyclic Oriented Matroids . . . . .	148
7.3	Generation of Abstract Order Types . . . . .	150
7.4	Polytopes and Matroid Polytopes . . . . .	154
7.5	A Conjecture Related to the Sylvester-Gallai Theorem . . . . .	156
<b>8</b>	<b>Complete Listing of Hyperplane Arrangements</b>	<b>161</b>
8.1	Introduction . . . . .	161
8.2	Hyperplane Arrangements and Affine Oriented Matroids . . . . .	162
8.3	Generation of Abstract Dissection Types . . . . .	164

<b>Bibliography</b>	<b>169</b>
<b>Glossary of Notation</b>	<b>175</b>
<b>Subject Index</b>	<b>177</b>

# List of Figures

1	Sphere arrangement . . . . .	3
2	Sphere arrangements of non-uniform and uniform oriented matroids . . . . .	6
3	Adjacent regions in sphere arrangement and tope graph . . . . .	6
4	Sphere arrangement and cocircuit graph . . . . .	7
5	Uncut regions in sphere arrangement ( $f = 4$ ) . . . . .	9
6	Coline cycles in M-labeled cocircuit graph . . . . .	10
7	Localizations of tope graph and cocircuit graph . . . . .	12
8	Signatures on coline cycles induced by a localization . . . . .	13
9	The 3 order types with 4 non-collinear points in $\mathbb{R}^2$ . . . . .	14
10	The 3 dissection types with 3 non-parallel hyperplanes in $\mathbb{R}^2$ . . . . .	14
0.1	Sphere arrangement . . . . .	18
0.2	Pseudosphere arrangement . . . . .	19
0.3	The big face lattice $\hat{\mathcal{F}}$ . . . . .	20
0.4	Diamond property . . . . .	45
1.1	Adjacent regions in pseudosphere arrangement and tope graph . . . . .	56
1.2	Tope graph of an oriented matroid of rank 2 . . . . .	61
1.3	Example for non-connectedness in the affine case . . . . .	63
1.4	Acycloid whose tope graph is not separable . . . . .	64
1.5	Acycloid which is not an oriented matroid but whose tope graph is separable . . . . .	65
1.6	The two cases in the proof of Theorem 1.3.1 . . . . .	65
2.1	Pseudosphere arrangement and cocircuit graph . . . . .	76

2.2	Diagram of reconstruction problems and results . . . . .	77
2.3	Cocircuit graph of an oriented matroid of rank 2 . . . . .	79
3.1	Diagrams of oriented matroids of rank 2 with 2 and 3 elements . . . . .	98
3.2	Diagrams of oriented matroids of rank 2 with 4 non-loop elements . . . . .	98
3.3	Relation of isomorphism classes of oriented matroids under single element extensions for $n \leq 5$ . . . . .	101
3.4	Extension of pseudosphere arrangement . . . . .	103
3.5	Localization of tope graph . . . . .	103
3.6	Localization of cocircuit graph . . . . .	104
5.1	The three possible types of a coline cycle . . . . .	122
5.2	Infeasible assignment of a coline cycle . . . . .	126
7.1	Sign vector defined by a hyperplane in a point configuration . . . . .	148
7.2	Point configuration and sphere arrangement . . . . .	149
7.3	The order types with 3 and 4 non-collinear points in $\mathbb{R}^2$ . . . . .	152
7.4	The 11 order types with 5 non-collinear points in $\mathbb{R}^2$ ; only the first 3 are non-degenerate . . . . .	152
7.5	The 93 order types with 6 non-collinear points in $\mathbb{R}^2$ ; only the first 16 are non-degenerate . . . . .	153
7.6	The counter-example with 9 points to Conjecture 7.5.1 . . . . .	159
8.1	Hyperplane arrangement and sphere arrangement . . . . .	163
8.2	The dissection types with 2 and 3 non-parallel hyperplanes in $\mathbb{R}^2$ . . . . .	166
8.3	The 8 dissection types with 4 non-parallel hyperplanes in $\mathbb{R}^2$ ; only the first is non-degenerate . . . . .	166
8.4	The 46 dissection types with 5 non-parallel hyperplanes in $\mathbb{R}^2$ ; only the first 6 are non-degenerate . . . . .	167



# List of Tables

0.1	List of covectors in $\mathcal{F}(A)$ . . . . .	16
0.2	Faces and corresponding sign vectors . . . . .	19
6.1	Lexicographic and reverse lexicographic order of bases ( $n = 5, r = 3$ ) . .	135
6.2	The 17 isomorphism classes in $IC(6, 3)$ . . . . .	136
6.3	Number of isomorphism classes of oriented matroids . . . . .	141
6.4	Number of isomorphism classes of uniform oriented matroids . . . . .	141
6.5	Number of non-realizable isomorphism classes of uniform oriented matroids	142
6.6	CPU time needed to compute isomorphism classes of oriented matroids .	143
6.7	Average CPU time needed to compute one isomorphism class (in mil- liseconds) . . . . .	143
6.8	Memory used to store isomorphism classes of oriented matroids (in bytes, where every byte has 8 bits) . . . . .	144
6.9	The 4 isomorphism classes in $IC(5, 3)$ . . . . .	145
6.10	The 12 isomorphism classes in $IC(6, 4)$ . . . . .	145
7.1	Number of abstract order types . . . . .	151
7.2	Number of non-degenerate abstract order types . . . . .	151
7.3	Number of non-realizable non-degenerate abstract order types of rank 3 .	151
7.4	Number of relabeling classes of matroid polytopes . . . . .	154
7.5	Number of combinatorial polytope types of matroid polytopes . . . . .	155
7.6	Number of combinatorial polytope types of simplicial matroid polytopes .	156
7.7	Cocircuits of oriented matroid violating Conjecture 7.5.2 . . . . .	158
7.8	Coordinates of point configuration violating Conjecture 7.5.1 . . . . .	159

7.9 Non-trivial collinearities of point configuration violating Conjecture 7.5.1 160

8.1 Number of abstract dissection types . . . . . 165

8.2 Number of non-degenerate abstract dissection types . . . . . 165

# List of Pseudo-Codes

1.1	Algorithm ACYCLOIDORIENTATIONRECONSTRUCTION . . . . .	67
1.2	Algorithm LOWERFACES . . . . .	70
1.3	Algorithm FACEENUMERATION . . . . .	70
1.4	Algorithm COVECTORSFROMCOCIRCUITS . . . . .	72
1.5	Algorithm TOPESFROMCOCIRCUITS . . . . .	73
2.1	Algorithm OMLABELFROMMLABEL . . . . .	81
2.2	Input and Output Specification of LISTCOLINECYCLES . . . . .	83
2.3	Input and Output Specification of MLABELFROMCOLINECYCLES . . . . .	83
2.4	Algorithm MLABELFROMAPLABEL . . . . .	84
4.1	Algorithm WEAKACYCLOIDALSIGNATURESREVERSESEARCH . . . . .	112
4.2	Algorithm WEAKACYCLOIDALSIGNATURESUPTOISOMORPHISM . . . . .	114
5.1	Algorithm LOCALIZATIONS_PATTERNBACKTRACK . . . . .	129



# Acknowledgements

I am very grateful to Prof. Komei Fukuda for the motivation to my research, his continuous stimulating support, and the numerous illuminating discussions which made this work possible.

I thank Prof. Hans-Jakob Lüthi for his generous support of this project at the Institute for Operations Research and for the discussions which helped to improve the presentation of this work considerably.

I am indebted to Prof. Günter M. Ziegler for his friendly support, his willingness to referee my thesis, and his helpful suggestions.

Thanks also to Prof. Eric Babson for his contributions, and I hope that we will meet some time. I also wish to thank Prof. Jürgen Bokowski for the valuable discussions on generation methods and various other topics. I am also thankful to all those which I do not mention here with which I had interesting discussions and communications.

Many thanks also to my present and former colleagues at the Swiss Federal Institute of Technology Zurich, especially at the Institute for Operations Research, which are, among others, Benno Büeler, Michael Burkard, Maurice Cochand, Arlette Gaillard, Jens Hensch, Thomas Herrmann, and Gerold Studer; I apologize to all those which are not mentioned here by name.

My warmest thanks to my wife Petra. You have been supporting me and my work with your love and encouraged me with your firm belief.



# Abstract

This thesis studies the reconstruction and generation of oriented matroids. Oriented matroids are a combinatorial abstraction of discrete geometric objects such as point configurations or hyperplane arrangements. Both problems, reconstruction and generation, address fundamental questions of representing and constructing (classes of) oriented matroids. The representations which are discussed in this thesis are based on graphs that are defined by the oriented matroids, namely tope graphs and cocircuit graphs. The first part of this thesis studies properties of these graphs and the question as to what extent oriented matroids are determined by these graphs. In the second part, these graph representations are used for the design of generation methods which produce complete lists of oriented matroids of given number of elements and given rank. These generation methods are used in the third part for the construction of a catalog of oriented matroids and of complete listings of the combinatorial types of point configurations and hyperplane arrangements.

The reconstruction problem is the problem of whether an oriented matroid can be reconstructed from some representation of it, which is here the tope graph and the cocircuit graph. It is known that tope graphs determine oriented matroids up to isomorphism. However, there is no simple graph theoretical characterization of tope graphs of oriented matroids. We strengthen the known properties of tope graphs and prove that for every element  $f$  the topes that are not bounded by  $f$  induce a connected subgraph in the tope graph. This property is later used for the design of generation methods that are based on tope graphs.

On the contrary to the tope graph case, it is known that cocircuit graphs do not determine isomorphism classes of oriented matroids. However, if every vertex is labeled by its supporting hyperplane, oriented matroids can be reconstructed up to reorientation. We present a simple algorithm which gives a constructive proof for this result. Furthermore, we extend the known results and show that the isomorphism class of a *uniform* oriented matroid is determined by its cocircuit graph. In addition, we present polynomial algorithms which provide a constructive proof to this result, and it is shown that the correctness of the input of the algorithms can be verified in polynomial time.

The generation problem asks for methods for listing all oriented matroids of given cardinality of the ground set and given rank. The known generation methods have been designed primarily for uniform oriented matroids in rank 3 or 4. Our methods are based on tope graph and cocircuit graph representations and generate all isomorphism classes of oriented matroids, including non-uniform ones in arbitrary rank. The generation approach incrementally extends oriented matroids by adding single elements. These single

element extensions are studied in terms of localizations of graphs, which are signatures on the vertex sets that characterize single element extensions.

The first two generation methods are based on tope graphs. These methods make use of the properties of tope graphs studied earlier in this thesis, especially of the new connectedness property. The first method is a reverse search method for the generation of generalized localizations in the tope graph. In the second method graph automorphisms are used to reduce the amount of isomorphic single element extensions. Furthermore we discuss techniques which reduce multiple extension of the same oriented matroid from different minors.

Two algorithms based on cocircuit graph representations are designed similarly to those based on tope graphs. However, all these first four generation methods lack efficiency, and a reason for this is that they do not use a good characterization of localizations. Due to a result of Las Vergnas, localizations of cocircuit graphs can be characterized by sign patterns on the coline cycles in the cocircuit graph. This allows us to design a fifth method which is efficient in practice. This method is a backtracking algorithm which enumerates all sign patterns of coline cycles that are feasible in terms of the characterization. It turns out that the method is similar to a method of Bokowski and Guedes de Oliveira for the uniform case. Our method is more general as it is capable to handle all oriented matroids in arbitrary rank, including non-uniform oriented matroids. Furthermore it uses an efficient data structure and a new dynamic ordering in the backtrack procedure.

The generation methods are used for the construction of a catalog of oriented matroids. This catalog is organized using basis orientations of oriented matroids. We discuss some properties of the catalog and a method to generate the catalog. The catalog of oriented matroids can be used to find complete listings of combinatorial types of point configurations and hyperplane arrangements. We study these listing problems and discuss solution methods. Furthermore we show by an example the potential of these complete listings in resolving geometric conjectures. The listings of oriented matroids, point configurations, and hyperplane arrangements can be accessed via the Internet on <http://www.om.math.ethz.ch>.



# Zusammenfassung

Diese Dissertation behandelt die Rekonstruktion und Erzeugung von Orientierten Matroiden. Orientierte Matroide sind eine kombinatorische Abstraktion von diskreten, geometrischen Objekten wie z. B. Punktkonfigurationen oder Hyperebenenarrangements. Beide Probleme, Rekonstruktion und Erzeugung, stellen fundamentale Fragen bezüglich der Darstellung und Herstellung von (Klassen von) Orientierten Matroiden. Die Darstellungen, welche in dieser Dissertation diskutiert werden, basieren auf Graphen, die durch die Orientierten Matroide definiert werden, nämlich Tope-Graphen und Kokreis-Graphen. Der erste Teil dieser Dissertation untersucht Eigenschaften dieser Graphen und die Frage, wie weit Orientierte Matroide durch diese Graphen bestimmt werden. Im zweiten Teil werden diese durch Graphen gegebenen Darstellungen für die Entwicklung von Erzeugungsmethoden verwendet, welche vollständige Listen von Orientierten Matroiden mit einer gegebenen Anzahl von Elementen und gegebenem Rang herstellen. Diese Erzeugungsmethoden werden im dritten Teil verwendet für die Erstellung eines Kataloges von Orientierten Matroiden und von vollständigen Auflistungen der kombinatorischen Typen von Punktkonfigurationen und Hyperebenenarrangements.

Das Rekonstruktionsproblem ist gegeben durch die Frage, ob ein Orientiertes Matroid von einer gewissen Darstellung von ihm wiederhergestellt werden kann; die hier betrachteten Darstellungen sind der Tope-Graph und der Kokreis-Graph. Es ist bekannt, dass Tope-Graphen Orientierte Matroide bis auf Isomorphie bestimmen. Allerdings gibt es keine einfache, graphentheoretische Charakterisierung der Tope-Graphen von Orientierten Matroiden. Wir erweitern die bekannten Eigenschaften von Tope-Graphen und beweisen, dass für jedes Element  $f$  die durch  $f$  nicht begrenzten Tope im Tope-Graphen einen zusammenhängenden Untergraphen induzieren. Diese Eigenschaft wird später für die Entwicklung von Erzeugungsmethoden verwendet, welche auf Tope-Graphen basiert sind.

Im Gegensatz zum Tope-Graphen bestimmt der Kokreis-Graph die Isomorphieklasse eines Orientierten Matroids nicht. Wenn aber jeder Knoten mit der Stützhyperebene markiert wird, kann das Orientierte Matroid bis auf Reorientierung rekonstruiert werden. Wir stellen einen einfachen Algorithmus vor, der dieses Ergebnis konstruktiv beweist. Ausserdem erweitern wir die bekannten Resultate und zeigen, dass die Isomorphieklasse eines *uniformen* Orientierten Matroids durch den Kokreis-Graphen bestimmt ist. Zudem stellen wir polynomiale Algorithmen vor, welche einen konstruktiven Beweis dieses Ergebnisses bieten, und es wird gezeigt, dass die Eingabe der Algorithmen in polynomialer Zeit auf Korrektheit überprüft werden kann.

Das Erzeugungsproblem verlangt nach Methoden zur Auflistung aller Orientierten Ma-

troide von gegebener Kardinalität der Grundmenge und gegebenem Rang. Die bekannten Erzeugungsmethoden wurden hauptsächlich für uniforme Orientierte Matroide im Rang 3 oder 4 entwickelt. Unsere Methoden basieren auf Darstellungen durch Tope-Graphen und Kokreis-Graphen und erzeugen alle Isomorphieklassen von Orientierten Matroiden, einschliesslich nicht-uniformer in beliebigem Rang. Der Erzeugungsansatz erweitert schrittweise Orientierte Matroide durch Hinzufügen einzelner Elemente. Diese 1-Element-Erweiterungen werden anhand von Lokalisierungen von Graphen untersucht, welches Signaturen auf der Knotenmenge sind, welche 1-Element-Erweiterungen charakterisieren.

Die ersten beiden Erzeugungsmethoden basieren auf Tope-Graphen. Diese Methoden machen Gebrauch von den Eigenschaften von Tope-Graphen, die vorher in dieser Dissertation untersucht wurden, besonders von der neuen Zusammenhangseigenschaft. Die erste Methode ist eine Umkehrsuchmethode für die Erzeugung von verallgemeinerten Lokalisierungen im Tope-Graphen. In der zweiten Methode werden Graphenautomorphismen verwendet, um die Menge von isomorphen 1-Element-Erweiterungen zu reduzieren. Weiter diskutieren wir Techniken, welche das mehrfache Erzeugen des gleichen Orientierten Matroids von verschiedenen Minoren vermindern.

Basierend auf Darstellungen mittels Kokreis-Graphen werden zwei Algorithmen entwickelt, ähnlich jenen, die auf Tope-Graphen basieren. Diese ersten vier Erzeugungsmethoden sind jedoch alle wenig leistungsfähig, und ein Grund dafür liegt darin, dass sie keine gute Charakterisierung von Lokalisierungen verwenden. Infolge eines Ergebnisses von Las Vergnas können Lokalisierungen von Kokreis-Graphen charakterisiert werden durch Vorzeichenmuster auf den Kolinien-Kreisen im Kokreis-Graph. Dies erlaubt uns, eine fünfte Methode zu entwickeln, welche in der Anwendung effizient ist. Diese Methode ist ein Rückverfolgungs-Algorithmus, welcher alle Vorzeichenmuster von Kolinien-Kreisen enumeriert, die zulässig sind im Sinne der Charakterisierung. Es stellt sich heraus, dass die Methode ähnlich ist zu einer Methode von Bokowski und Guedes de Oliveira für den uniformen Fall. Unsere Methode ist allgemeiner, da sie alle Orientierten Matroide in beliebigem Rang behandeln kann, einschliesslich nicht-uniformer Orientierter Matroide. Zudem benutzt sie eine effiziente Datenstruktur und eine neue dynamische Reihenfolge im Rückverfolgungs-Verfahren.

Die Erzeugungsmethoden werden für die Erstellung eines Kataloges von Orientierten Matroiden verwendet. Dieser Katalog wird mittels Basisorientierungen von Orientierten Matroiden organisiert. Wir diskutieren einige Eigenschaften des Kataloges und eine Methode für die Erzeugung des Kataloges. Der Katalog von Orientierten Matroiden kann verwendet werden, um vollständige Auflistungen der kombinatorischen Typen von Punktkonfigurationen und Hyperebenenarrangements zu finden. Wir untersuchen diese Auflistungsprobleme und diskutieren Lösungsmethoden. Weiter zeigen wir mit einem Beispiel das Potential dieser vollständigen Auflistungen im Lösen von geometrischen Vermutungen. Die Auflistungen von Orientierten Matroiden, Punktkonfigurationen und Hyperebenenarrangements sind im Internet zugänglich unter <http://www.om.math.ethz.ch>.

# Structure Diagram

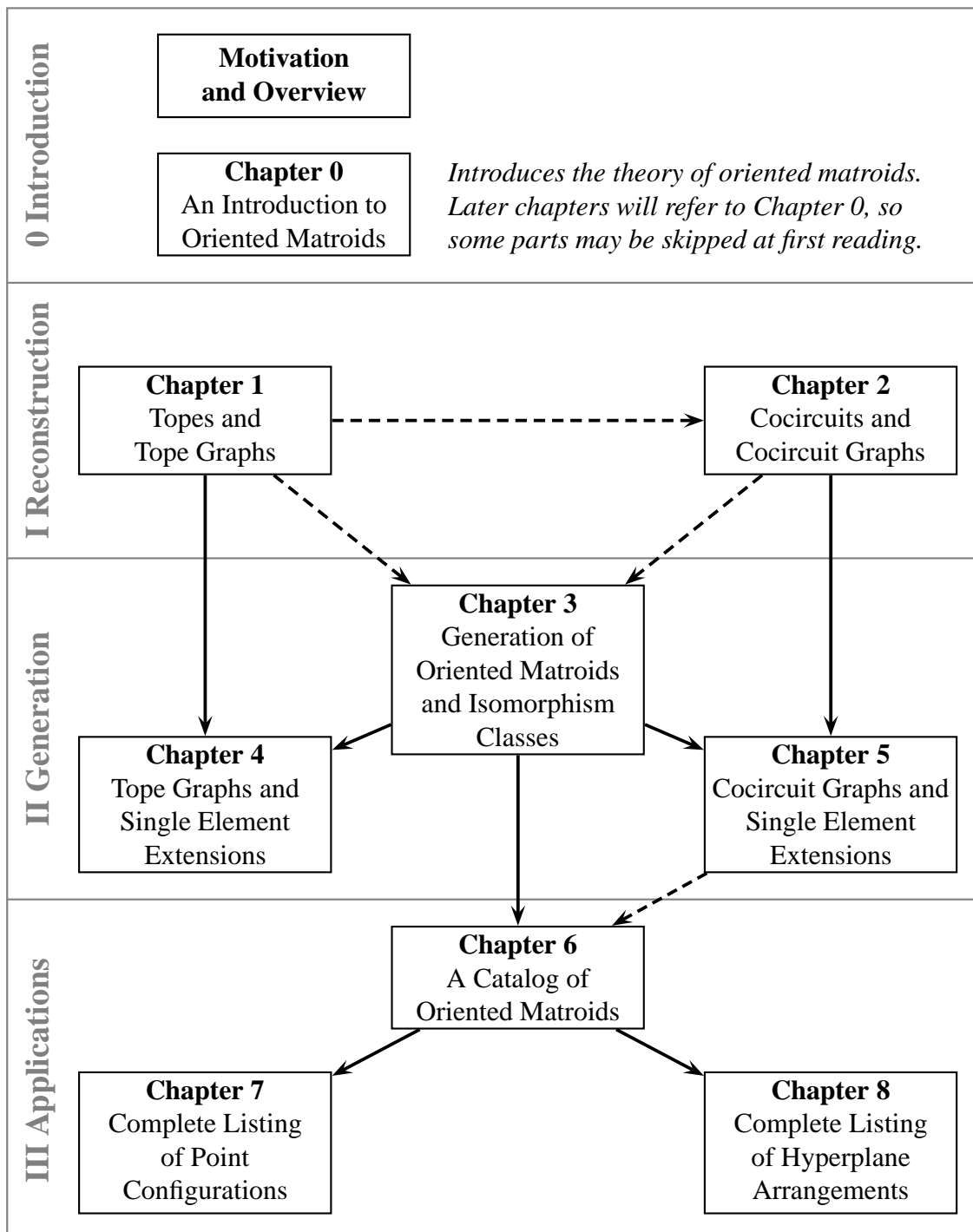



A large, light gray, sans-serif capital letter 'O' is centered on the page. Inside the white space of the 'O', the word 'Introduction' is written in a bold, black, serif font.

# **Introduction**



# Motivation and Overview

## Introduction

Oriented matroids are a natural mathematical notion which may be viewed as a combinatorial abstraction of real hyperplane arrangements, convex polytopes, or point configurations in the Euclidean space. The notion of oriented matroids was introduced in the late seventies independently by Bland and Las Vergnas [BLV78] and by Folkman and Lawrence [FL78]. There are several different (but equivalent) axiom systems and representations of oriented matroids, and the theory of oriented matroids has connections and applications to many areas of mathematics. These areas include combinatorics, discrete and computational geometry, optimization, and graph theory.

We illustrate oriented matroids in the following by sphere arrangements. A more detailed introduction to oriented matroids is given in Chapter 0. For a most comprehensive presentation of the theory of oriented matroids we refer to the monograph of Björner, Las Vergnas, Sturmfels, White, and Ziegler [BLVS<sup>+</sup>99].

A finite sphere arrangement  $\mathcal{S} = \{S_e \mid e \in E\}$  in the Euclidean space  $\mathbb{R}^{d+1}$  is a collection of  $(d - 1)$ -dimensional unit spheres on the  $d$ -dimensional unit sphere  $S^d$ , where every sphere  $S_e$  is oriented (i.e. has a  $+$  side and a  $-$  side). Figure 1 shows an example for  $d = 2$  with  $|E| = 4$  spheres; in the following we will refer to this example several times.

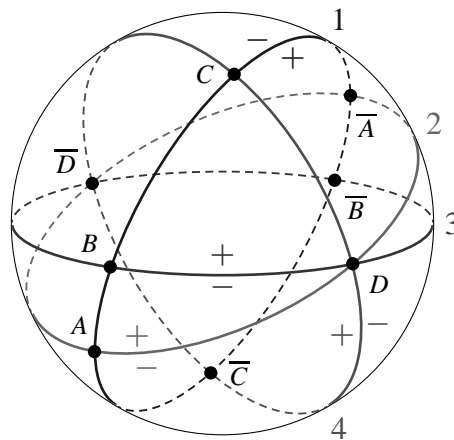

Figure 1: Sphere arrangement

The sphere arrangement  $\mathcal{S}$  induces a cell complex  $\mathcal{K}$  on  $S^d$ . For every point  $x$  on  $S^d$  we define a *sign vector*  $X \in \{-, +, 0\}^E$  by setting  $X_e = 0$  if  $x$  is on  $S_e$ , otherwise  $X_e = +$  (or  $X_e = -$ ) if  $x$  is on the  $+$  side (or  $-$  side, respectively) of  $S_e$ . For example, the point  $A$  in Figure 1 is associated to the sign vector  $(0\ 0\ -\ +)$ , and a point in the (relative interior of) region  $BCD$  is mapped to  $(+\ +\ +\ +)$ . We call these sign vectors *covectors* and denote the set of all covectors by  $\mathcal{F}$ . Obviously there is a one-to-one correspondence between the cells in  $\mathcal{K}$  and the covectors in  $\mathcal{F}$ . Furthermore the facial relationship in  $\mathcal{K}$  can be recognized in  $\mathcal{F}$ : for covectors  $X, Y \in \mathcal{F}$ ,  $X$  corresponds to a subspace of the face corresponding to  $Y$  if and only if  $X_e \neq 0$  implies  $X_e = Y_e$  for all  $e \in E$ . By this,  $\mathcal{K}$  and  $\mathcal{F}$  have the same face poset. We call  $(E, \mathcal{F})$  *the oriented matroid defined by  $\mathcal{S}$* . Whereas  $\mathcal{S}$  and  $\mathcal{K}$  are geometric objects, the corresponding oriented matroid  $(E, \mathcal{F})$  is purely combinatorial, reflecting the relative positions of the cells in the complex  $\mathcal{K}$  only. In general, oriented matroids are defined by axioms for  $\mathcal{F}$ . Not every oriented matroid has a realization by a sphere arrangement, but every oriented matroid can be represented by a topological sphere arrangement ([FL78, Man82], see also Chapter 0).

For the study of combinatorial objects, an axiomatic foundation as in the theory of oriented matroids is a crucial advantage, as compared to direct work on geometric realizations where such a foundation is missing. By their axioms, oriented matroids have polynomial characterizations; on the other hand it is *NP*-hard to decide whether an oriented matroid has a realization (by a sphere arrangement) or not [Mnë88, Sho91], i.e., there is no polynomial characterization of the combinatorial structure (in the sense of an oriented matroid) of a sphere arrangement unless  $P = NP$ . Furthermore, there are methods to decide whether an oriented matroid is realizable or not which work satisfactory for small instances [RG92].

In addition to the existence of axioms, the finiteness of oriented matroids can guarantee the completeness of investigations. For given dimension and number of spheres there exists an infinite number of sphere arrangements, whereas there are only finitely many combinatorial types of such arrangements, i.e., there is only a finite number of different face posets of oriented matroids. Many combinatorial problems are so difficult that often the most promising way is the enumeration of all possible cases. For combinatorial problems which arise from geometry and have an abstraction in terms of oriented matroids the enumeration of all cases is, in principle, possible because of the finiteness and the axiomatic foundation of oriented matroids. The following two examples may illustrate the importance of methods for the generation of oriented matroids.

The geometric realization of triangulated 2-manifolds is the problem whether some given triangulated (topological) 2-manifold has a polyhedral embedding in  $\mathbb{R}^3$ . In other words, for a list of triangles on  $n$  vertices which describe an abstract 2-complex, the problem is to decide whether there are coordinates for the vertices such that the triangles in the list correspond to non-intersecting facets of a geometric 2-manifold. For 2-manifolds of genus  $g = 0$  (i.e., spheres) the problem is decidable because of Steinitz's theorem: the 2-manifold is realizable if and only if the graph defined by the adjacency of the vertices is planar and 3-connected. For 2-manifolds of genus  $g > 0$  (spheres with  $g$  handles) the problem was posed by Grünbaum (Exercise 3 of Section 13.2 in [Grü67]) and is wide open; only certain smaller instances are decided. A remarkable progress has been recently



made by Bokowski and Guedes de Oliveira [BGdO00] who proved by enumeration of oriented matroids that there is no realization of a certain 2-manifold with  $n = 12$  vertices which has genus  $g = 6$ . For a more detailed survey on polyhedral 2-manifolds see Section A.7 in [BLVS<sup>+</sup>99].

The order type of a point configuration, as introduced by Goodman and Pollack [GP83], is the combinatorial type described by all the relative positions in a finite set of points in the Euclidean space. Many problems in combinatorial geometry are stated in terms of point configurations, and there have been early attempts to list all order types, or all combinatorial types of related structures such as hyperplane arrangements. However, these listings could consider only very small cases, configurations of at most 5 points in [GP80a] or (projective) hyperplane arrangements of at most 6 hyperplanes in [Grü72]). Furthermore the completeness of the listings was not always clear (e.g., in an earlier list of all arrangements of at most 6 hyperplanes in Section 18.1 of [Grü67] one case was missing). Often the listing was restricted to some special, non-degenerate cases in  $\mathbb{R}^2$ . Recently there has been a considerable progress in the enumeration of non-degenerate order types of point configurations in the Euclidean plane by Aichholzer et al. [AAK01], by this establishing the first data base of all non-degenerate order types for  $n \leq 10$  points in  $\mathbb{R}^2$ . This data base has been constructed by generation of certain representations of oriented matroids which have been realized by coordinates as far as possible, where the completeness of the listing has been guaranteed by known realizability results from the literature (e.g., see [Bok93]). Applications of the order type data base to several problems in computational and combinatorial geometry [AK01] has shown the usefulness of such listings.

## Problems and Goals

A main goal of this thesis is to investigate and develop methods which generate complete listings of oriented matroids of given size. Techniques for listing oriented matroids for small  $n = |E|$  and  $d$  have been studied, among others, by Bokowski, Sturmfels, and Guedes de Oliveira (e.g., [BS87, BS89, BGdO00]). However, it seems that the methods are designed primarily for the case of uniform oriented matroids and low dimension ( $d = 2$  or  $d = 3$ ). Uniform oriented matroids are those which correspond to non-degenerate (pseudo-)sphere arrangements, i.e., the spheres are assumed to be in general position (see Figure 2). Our goal is to find methods which work for general oriented matroids in arbitrary dimension, including non-uniform oriented matroids.

Many questions which can be solved when having a complete list of oriented matroids only depend on the isomorphism class, which is the equivalence class under reorientation and relabeling of the elements. An illustration of isomorphism classes are arrangements of unoriented and unlabeled spheres (as showed in Figure 2). Important combinatorial properties such as the face poset only depend on the isomorphism class, even more, the face poset determines the isomorphism class. However, the face poset is a rather complicated and very redundant structure and hence not well suited for practical purposes. It will be sufficient to use only parts of the face poset, namely two graphs which are defined by

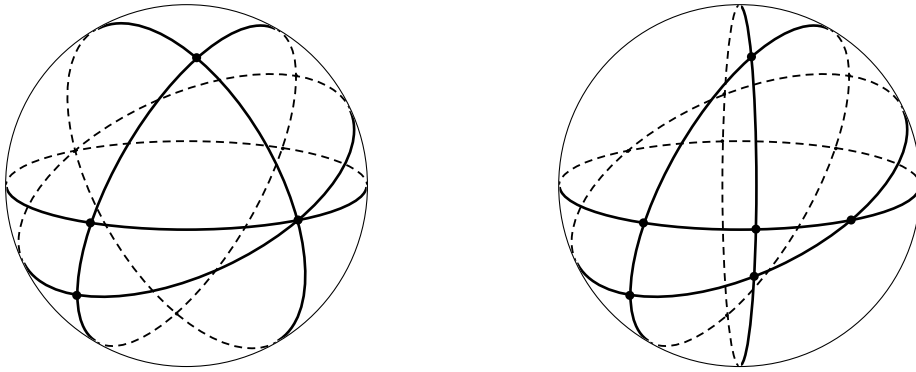

Figure 2: Sphere arrangements of non-uniform and uniform oriented matroids

the face poset, the so-called *tope graph* and the *cocircuit graph*. These graphs will serve as a base of rather simple and compact representations of isomorphism classes of oriented matroids and will be helpful for the design of methods that solve the problem which we posed above: the generation of isomorphism classes of arbitrary oriented matroids.

Consider again the  $d$ -dimensional sphere arrangement  $\mathcal{S}$  with corresponding cell complex  $\mathcal{K}$  and oriented matroid  $\mathcal{M} = (E, \mathcal{F})$  as introduced above. The cells of maximal dimension  $d - 1$  in  $\mathcal{K}$  are called *regions* and the corresponding covectors in  $\mathcal{F}$  *topes*. Two regions are called *adjacent* if they have a common  $(d - 2)$ -dimensional face, and this is the case if and only if the corresponding topes  $X$  and  $Y$  disagree in exactly one sign. This defines an adjacency notion for topes and by this a graph whose vertices correspond to topes, which is called the *tope graph* of the oriented matroid. Figure 3 shows the cell complex with two adjacent regions  $ABD$  and  $BCD$ , which correspond to the adjacent topes  $(++-+)$  and  $(++++)$ , and the tope graph of the corresponding oriented matroid.

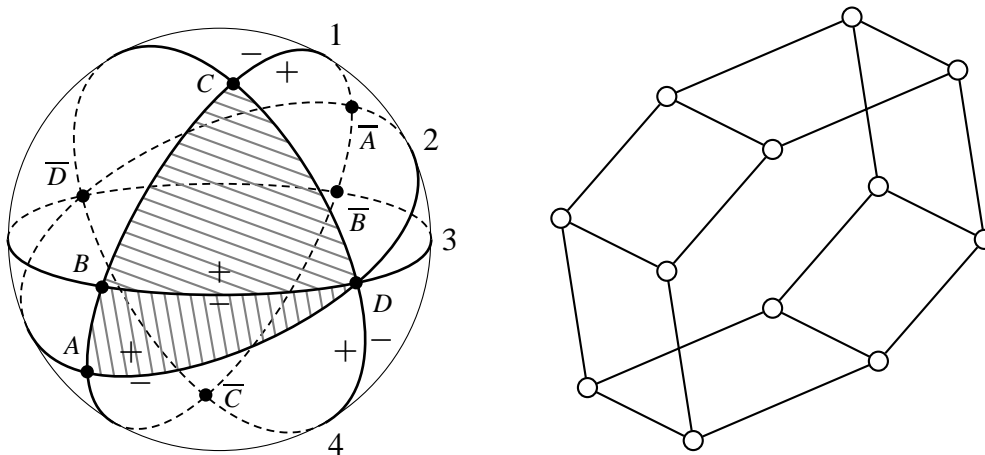

Figure 3: Adjacent regions in sphere arrangement and tope graph

It is known that the tope graph determines the whole face poset [BEZ90]. This motivates to use tope graphs as a representation of isomorphism classes. This brings up two problems: to reconstruct an oriented matroid for a given tope graph, and to decide whether a given graph is the tope graph of some oriented matroid or not. For example, it is known that every tope graph is bipartite and embeddable in some hypercube, but this is not a characterization. It is a goal of the thesis to review known results, to extend them, and to discuss algorithmic solutions for these reconstruction and characterization problems. These investigations will enable us to design algorithms for the generation of tope graphs of oriented matroids, hence for the generation of oriented matroids up to isomorphism.

A second graph which is defined by the face poset is the *cocircuit graph*. Consider again the sphere arrangement  $\mathcal{S}$  as introduced above. The cells of minimal dimension (i.e., the 0-dimensional cells) in  $\mathcal{K}$  are the vertices of a graph whose edges correspond to the 1-dimensional cells in  $\mathcal{K}$ , i.e., two vertices are adjacent if they are the two endpoints of a 1-dimensional cell in  $\mathcal{K}$ . In short, this graph is the 1-skeleton of  $\mathcal{K}$ . In the oriented matroid  $\mathcal{M} = (E, \mathcal{F})$  defined by  $\mathcal{S}$ , the covectors which correspond to 0-dimensional cells are called *cocircuits*. The adjacency for cocircuits corresponding to the one of vertices in  $\mathcal{K}$  is defined by the facial relationship of covectors as defined above. In the example from above consider two cocircuits, say  $(0 + 0 +)$  and  $(+ 0 0 0)$ , which correspond to the vertices  $B$  and  $D$  in the sphere arrangement. These cocircuits are adjacent since they are the only two proper subfaces of  $(+ + 0 +) \in \mathcal{F}$ , which corresponds to the face  $BD$  in  $\mathcal{K}$ . The adjacency relation of cocircuits defines the *cocircuit graph* of an oriented matroid (see also Figure 4). Cocircuit graphs are quite different from tope graphs, e.g., a cocircuit

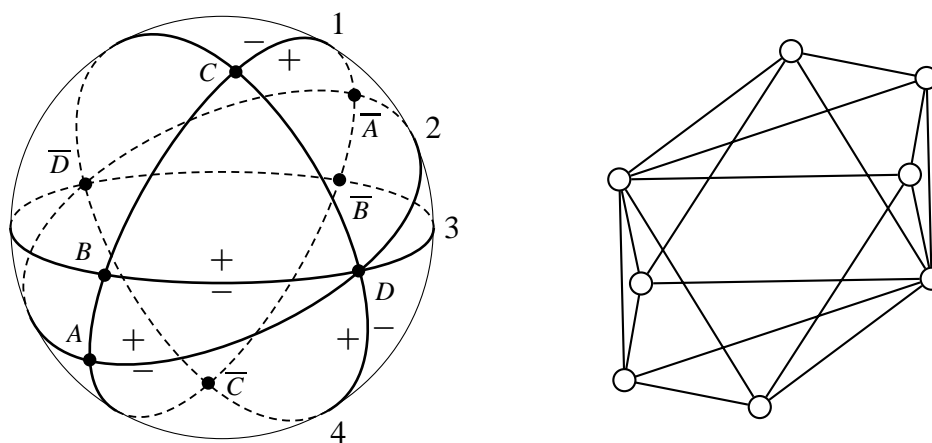

Figure 4: Sphere arrangement and cocircuit graph

graph is not bipartite for  $d \geq 2$ . Furthermore, it is known that cocircuit graphs do not characterize the face poset [CFGdO00]. Nevertheless, when some information is added to the graph, such as vertex labels which indicate for every vertex  $v$  the set of spheres which contain  $v$ , the face poset can be reconstructed. It is a goal of this thesis to investigate cocircuit graphs and the corresponding reconstruction and characterization problems. Similar to tope graphs we will investigate algorithmic solutions for these problems, and it will turn out that cocircuit graphs can be used as a base for the design of efficient generation

algorithms of oriented matroids.

The goal to find methods for the generation of oriented matroids up to isomorphism has led to the consideration of graph representations, namely tope graphs and cocircuit graphs. The better these graph representations are understood and characterized, the better they can be used for generation methods. On the other hand, from a more intrinsic point of view, our understanding of tope graphs and cocircuit graphs will profit from the investigation of algorithms for reconstruction and generation of oriented matroids.

## Main Results

Part I of this thesis discusses the reconstruction and characterization problems of tope graphs and cocircuit graphs, whereas Part II is devoted to generation methods. Part III will show some applications, namely the construction of a catalog of oriented matroids and of complete listings of combinatorial types of point configurations, polytopes, and hyperplane arrangements. For an overview of the dependencies of the chapters see also the structure diagram on page xix.

*Chapter 0* introduces the theory of oriented matroids, presenting the notation, several axiom systems and results from the theory of oriented matroids which are used in this thesis. Although there are no new results in this chapter, the presentation and also most of the proofs have been written for the purpose of introducing the basic material of the thesis, which also caused a selection of the known results and a discussion from a personal point of view. Later chapters will depend on Chapter 0 and refer to it whenever necessary.

### Part I Reconstruction and Characterization Problems

*Chapter 1* discusses tope graphs of oriented matroids. We define tope graphs in Section 1.1 and address the two main problems considered in Chapter 1, the characterization problem and the reconstruction problem of tope graphs. The characterization problem is the problem to decide whether a given graph is the tope graph of some oriented matroid. The reconstruction problem is the problem to find for a given tope graph  $G$  an oriented matroid  $\mathcal{M}$  such that  $G$  is the tope graph of  $\mathcal{M}$ . The investigation of these problems is organized as follows.

Section 1.2 reviews some properties of tope graphs which are known from the literature [FH93] which state that tope graphs can be embedded in some higher-dimensional hypercube such that distances in the tope graph and in the hypercube coincide. These properties are not sufficient to characterize tope graphs of oriented matroids; in fact, no characterization of tope graphs is known which can be verified in the graph in polynomial time.

A first main result of this thesis is a connectedness (or separability) property established in Section 1.3. Consider again the example introduced above, and choose an arbitrary element  $f$ , say  $f = 4$ . The sphere arrangement  $\mathcal{S}$  can be constructed by inserting  $S_4$  as a new sphere in  $\mathcal{S} \setminus f := \{S_1, S_2, S_3\}$ . The regions of  $\mathcal{S}$  are obtained from the regions

in  $\mathcal{S} \setminus f$  by dividing some regions, those *cut* by  $S_4$ , into two new regions; the remaining regions stay unchanged, we call these *uncut* regions. Figure 5 shows the uncut regions for  $f = 4$ . Correspondingly, we call a tope  $X$  an *uncut tope* if the sign vector  $\overline{f}X$ , which

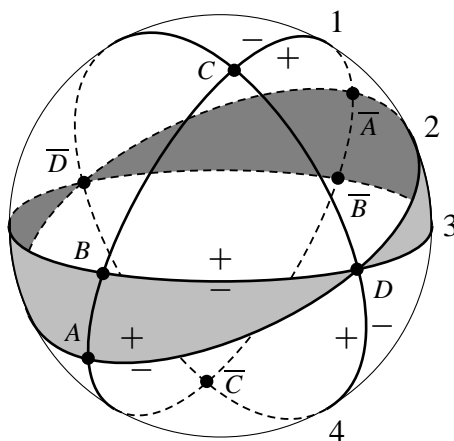

Figure 5: Uncut regions in sphere arrangement ( $f = 4$ )

is obtained from  $X$  by reversing the sign in  $f$ , is not a tope. We prove that if there exist uncut tope for some given  $f$  then the subgraph induced in the tope graph by uncut tope has exactly two connected components. Stated differently, the new element  $f$  *separates* the uncut tope in two connected parts which correspond to the  $-$  and the  $+$  side of  $f$ . The proof of this connectedness property uses nontrivial inductive arguments and results from oriented matroid programming, which is an abstraction of linear programming. The property can be verified easily for a given tope graph (without knowledge of tope as sign vectors) and is independent from the known properties of tope graphs as we show by an example. Still, the new result does not lead to a graph theoretical characterization of tope graphs of oriented matroids, as we can give another example which satisfies the known tope graph properties (including the connectedness for every element  $f$ ) but is not a tope graph of an oriented matroid.

Section 1.4 discusses the reconstruction problem for tope graphs which can be solved by a simple algorithm of Cordovil and Fukuda [CF93]. This algorithm makes it possible to characterize tope graphs of oriented matroids by use of an algorithmic characterization of tope sets, which is discussed in the last three sections of Chapter 1. The problem to decide whether a given set  $\mathcal{T}$  of sign vectors is the tope set of some oriented matroid is solved in three steps. A first algorithm due to Fukuda, Saito, and Tamura [FST91] constructs (in polynomial time) from  $\mathcal{T}$  a set of sign vectors  $\mathcal{D}$  such that if  $\mathcal{T}$  is a set of tope then  $\mathcal{D}$  is the corresponding set of cocircuits. In a second step  $\mathcal{D}$  is tested to be the set of cocircuits of some oriented matroid, which is possible in polynomial time using the cocircuit axioms of oriented matroids. Finally, we present an algorithm which constructs the set of tope  $\mathcal{T}'$  from the cocircuits  $\mathcal{D}$ . If  $\mathcal{T}$  is the set of tope of some oriented matroid then  $\mathcal{T} = \mathcal{T}'$ , otherwise the method recognizes that this is not the case. The algorithm for the construction of tope from cocircuits is proved to be polynomial in the sizes of input and output; this extended notion of polynomiality [Fuk96, Fuk00a, Fuk01] is used since the number of tope can be exponential in the number of cocircuits.

Chapter 2 discusses the reconstruction and characterization problems concerning cocircuit graphs. An example of Cordovil, Fukuda, and Guedes de Oliveira [CFGdO00] shows that the cocircuit graph of an oriented matroid does not characterize the face poset. However, the question remained open for cocircuit graphs of uniform oriented matroids (which we will simply call *uniform cocircuit graphs*), and positive answers are possible when some information about the oriented matroid is added to the cocircuit graph, as we discuss in the following using the notion of labels. We define three types of labels:

- An *OM-label* (oriented matroid label) of a cocircuit graph is a map  $\mathcal{L}$  that associates every vertex in the cocircuit graph to its corresponding cocircuit. In the example presented above, the vertex  $C$  is mapped to  $\mathcal{L}(C) = (0 \ + \ + \ 0)$ .
- An OM-label  $\mathcal{L}$  induces an *M-label* (matroid label)  $L$  which carries the underlying matroid information only, i.e.,  $L$  maps every vertex  $v$  to the set of elements which correspond to 0 signs in  $\mathcal{L}(v)$ . We write this definition as  $L(v) := \mathcal{L}(v)^0$  for every vertex  $v$ . In the example from above,  $\mathcal{L}(C) = (0 \ + \ + \ 0)$  induces  $L(C) = \{1, 4\}$ .
- An M-label induces an *AP-label* (antipode label) by mapping every vertex  $v$  to the so-called *antipode*  $\bar{v}$  of  $v$  which is characterized by  $L(v) = \overline{L(\bar{v})}$  and  $v \neq \bar{v}$ . In the example of above, the vertex  $C$  is mapped to its antipode  $\bar{C}$ .

In addition to labels there is the notion of *coline cycles* in cocircuit graphs which play an important role for reconstruction and also later for generation methods. In a sphere arrangement a coline cycle is the subgraph induced in the cocircuit graph by the 1-dimensional intersection of a number of spheres. In our example on  $S^2$  each coline cycle is trivially given by the edges belonging to one sphere. In the M-labeled cocircuit graph of an oriented matroid a coline cycle is the subgraph induced by the edges having same M-label, where the M-label of an edge is defined as the intersection of the vertex labels of the two end points; in fact, a coline cycle is always a cycle in the cocircuit graph. Figure 6 shows the M-labeled cocircuit graph and indicates the coline cycles.

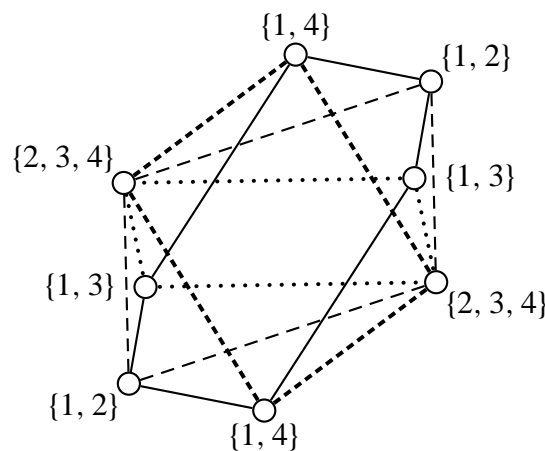

Figure 6: Coline cycles in M-labeled cocircuit graph

As a result of Cordovil, Fukuda, and Guedes de Oliveira [CFGdO00] the M-labeled cocircuit graph determines the oriented matroid up to reorientation. We present in Section 2.2 a simple algorithm for the orientation reconstruction from an M-labeled cocircuit graph. The idea is based on a connectedness property [CFGdO00] which is similar to that discussed above for tope graphs: let  $f$  be an arbitrary element and consider the subgraph  $G(f)$  induced in the cocircuit graph by the vertices  $v$  for which  $f$  is not in  $L(v)$ ; then two vertices  $v, w$  are connected in  $G(f)$  if and only if  $\mathcal{L}(v) = \mathcal{L}(w) \neq 0$  for any OM-label  $\mathcal{L}$  that induces  $L$ .

As one of the major results in this thesis we prove that the cocircuit graph of a *uniform* oriented matroid determines its isomorphism class. This strengthens the known result that the isomorphism class is determined by an AP-labeled uniform cocircuit graph [CFGdO00]. We prove the known and the new result providing (polynomial) algorithms which reconstruct the isomorphism class in several steps. The reconstruction of an oriented matroid from a given M-labeled cocircuit graph has been considered above. Section 2.3 presents two algorithms, one for the reconstruction of an M-label of a uniform cocircuit graph from the set of colines cycles, a second which finds the set of colines cycles from an AP-label. In Section 2.4 we show how an AP-label of a given uniform cocircuit graph can be constructed in polynomial time. A first important result is that an AP-label of a uniform cocircuit graph is determined by only two pairs of antipodal vertices which are known to be on a common coline cycle. The main theorem states that the AP-label of a uniform cocircuit graph  $G$  is determined by  $G$  up to graph automorphisms. The proof of this theorem considers the automorphism group  $\text{Aut}(G)$  and is based on the previous reconstruction results of Chapter 2.

We discuss in Section 2.5 how the correctness of the input of our algorithms can be checked in polynomial time. This solves the characterization problem for cocircuit graphs of uniform oriented matroids and for M-labeled cocircuit graphs algorithmically (i.e., we do not give a direct graph theoretical characterization).

The results of Chapter 2 are also related to Perles's conjecture which says that the 1-skeleton of a simple  $d$ -dimensional polytope determines its face poset; this conjecture was first proved by Blind and Mani-Levitska [BML87] and then constructively by Kalai [Kal88]. If an oriented matroid is realizable, the cell complex  $\mathcal{K}$  formed by  $\mathcal{F}$  is isomorphic to the face poset of the dual of a zonotope (zonotopes are polytopes which are projections of higher-dimensional hypercubes), i.e., the present work extends the discussion of Perles's conjecture to a class of non-simple polytopes. Joswig [Jos00] conjectured that every cubical polytope (i.e., every  $(d - 1)$ -dimensional face is isomorphic to a hypercube) can be reconstructed from its dual graph; our result proves this conjecture for the special case of cubical zonotopes up to graph isomorphism. In other words, the face poset of every cubical zonotope is uniquely determined by its dual graph up to isomorphism.

## Part II Generation Methods

*Chapter 3* introduces the generation problem of oriented matroids and presents an incremental method for the generation of isomorphism classes. In this incremental method

oriented matroids are generated by single element extensions, i.e., oriented matroids are extended to new oriented matroids by introducing one element after the other. This approach is the one also used in former methods [BS87, BS89, BGdO00]. New is that we use tope graphs and cocircuit graphs and that all oriented matroids in arbitrary dimension are considered. Single element extensions are represented in tope graphs and cocircuit graphs by signatures on the vertex sets, so-called *localizations*. Consider again the example of above. The sphere arrangement  $\mathcal{S}$  is obtained from  $\mathcal{S} \setminus f$  as a single element extension by adding  $S_f$ . This defines localizations of the vertex sets of the tope graph and cocircuit graph of  $\mathcal{S} \setminus f$  as follows. In the tope graph, every vertex which corresponds to a region that is divided by  $f$  into two new regions is labeled by a 0 sign, the other vertices by a  $-$  or  $+$  sign according to whether the corresponding regions are on the  $-$  or  $+$  side of  $f$ . In the cocircuit graph, every vertex takes a  $-$ ,  $+$ , or  $0$  sign according to whether it is on the  $-$  or  $+$  side of  $f$  or contained in  $f$ . Figure 7 shows the localizations in the tope graph and cocircuit graph of  $\mathcal{S} \setminus f$  for the above example and  $f = 4$ .

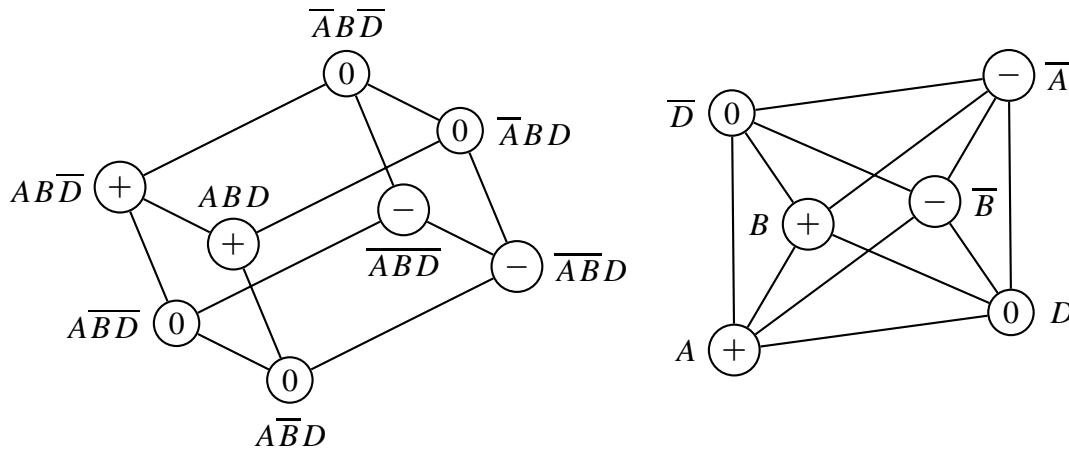

Figure 7: Localizations of tope graph and cocircuit graph

Chapter 4 presents generation methods that are based on tope graphs. Section 4.1 discusses the strong relation between automorphisms of tope graphs and isomorphisms in oriented matroids and presents an algorithm for testing isomorphisms of tope graphs. Section 4.2 gives a formal definition of localizations of tope graphs and discusses the relation to single element extensions and properties of localizations. We use the connectedness of uncut topes from Chapter 1 to prove that for any tope graph  $G$  and localization  $\sigma$  of  $G$  the subgraph in  $G$  induced by the vertices  $v$  with  $\sigma(v) = -$  is connected. This property is essential for the design of two algorithms in Sections 4.3 and 4.4 for the generation of localizations. Both methods generate a superset of localizations, so-called *weak localizations*; every weak localization can be tested for being a localization using the characterization algorithms from Chapter 1. The first algorithm is a reverse search method [AF96] which generates every weak localization once without repetition. The second algorithm incorporates isomorphism tests in order to reduce the amount of enumeration as we are only interested in generating oriented matroids up to isomorphism. Both methods are new methods for the generation of oriented matroids and not similar to any of the known methods. However, they turn out to be of limited use in practice. It seems that the absence of



a good characterization of localizations in tope graphs causes these methods to become inefficient as the number of elements increases. Hence these methods will not be used for the generation of oriented matroids in practice.

Chapter 5 presents generation methods based on the cocircuit graph of oriented matroids. In contrast to tope graphs, cocircuit graphs do not characterize isomorphism classes of oriented matroids. However, the results of Chapter 2 show that an M-labeled cocircuit graph, whose M-label is considered up to relabeling, characterizes the isomorphism class of the corresponding oriented matroid. This representation is useful in Section 5.1 where we discuss the relation between automorphisms of cocircuit graphs and isomorphisms of oriented matroids and where we present an algorithm for testing isomorphisms of cocircuit graphs. Section 5.2 formally defines localizations of cocircuit graphs and discusses the relation to single element extensions. The connectedness result which was already helpful for the orientation reconstruction in Chapter 2 is used for designing two generation algorithms based on cocircuit graphs which are similar to those for tope graphs in Chapter 4. The signatures produced by these algorithms form a superset of all localizations of a cocircuit graph, which are characterized by the following result of Las Vergnas [LV78b]: a signature is a localization of a cocircuit graph (given with a set of coline cycles) if and only if for every coline cycle the induced signature is of one of the three types given in Figure 8. This characterization is used in Section 5.4 for the design of an effi-

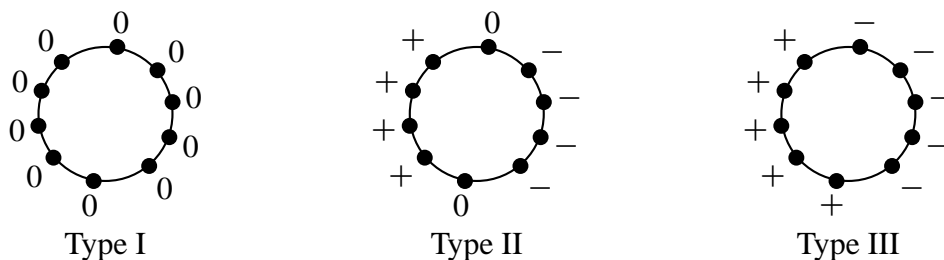

Figure 8: Signatures on coline cycles induced by a localization

cient generation method. This method is basically a backtracking algorithm which fixes signatures on coline cycles one after the other, where all possibilities according to the above characterization are considered as long as there is no conflict with previously fixed patterns of coline cycles. It turned out that our method is similar to a method of Bokowski and Guedes de Oliveira [BGdO00] for the uniform case. However, our method is more general as it is capable to handle all oriented matroids in arbitrary rank, including non-uniform oriented matroids. Furthermore, our method introduces two new concepts which are important for practical efficiency. First, the backtracking algorithm uses a *dynamic ordering* of the coline cycles in order to reduce the amount of enumeration. Second, the algorithm uses a *coline adjacency matrix* which reflects the mutual intersection of coline cycles; by this the amount of time spent for one step in the backtracking method becomes very small. Computational experiments show that our method generates only relatively few infeasible situations where a partial assignment of patterns to coline cycles cannot be completed to a localization, which finally explains its practical efficiency.

## Part III Applications

*Chapter 6* presents a catalog of oriented matroids up to isomorphism whose computation is based on the methods presented earlier in this thesis. We discuss the organization of the catalog which uses basis orientations (chirotopes) for the encoding of the representative of every isomorphism class. Furthermore a method is presented which generates the catalog. Finally we give an overview of the results, also indicating CPU time usage and memory usage. We consider this catalog to be a major step forward as it is the first such catalog which includes not only uniform oriented matroids but all cases in arbitrary dimension.

*Chapter 7* discusses how the catalog of oriented matroids from *Chapter 6* can be used for the generation of complete listings of the combinatorial types of point configurations, so-called *order types* [GP83]. Figure 9 shows an example of such a list; see Figures 7.4 and 7.5 for the analogous listings with 5 and 6 points. These listings are the first such

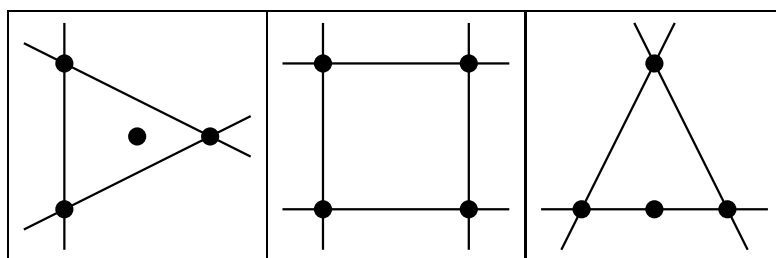

Figure 9: The 3 order types with 4 non-collinear points in  $\mathbb{R}^2$

listings which also include degenerate point configurations. We use these listings for an alternative proof of the classifications of polytopes [Grü67, AS84, AS85] and show their potential in resolving geometric conjectures.

*Chapter 8* considers the problem of generating all combinatorial types of hyperplane arrangements, which we call *dissection types*. Figure 10 shows an example of such a list;

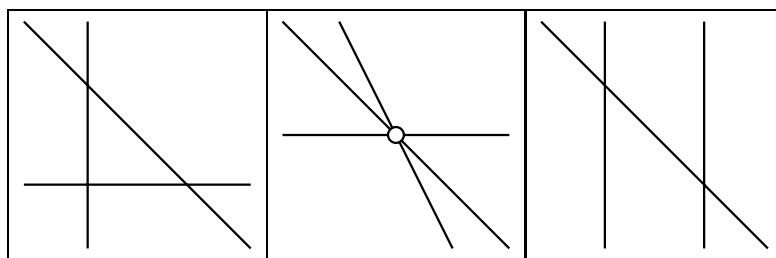

Figure 10: The 3 dissection types with 3 non-parallel hyperplanes in  $\mathbb{R}^2$

for arrangements with of more lines see Figures 8.3 and 8.4. We give complete listings which again are first of this kind as they include all degenerate cases. We consider these listings to be an interesting source for future investigations.

The catalogs of oriented matroids, point configurations, and hyperplane arrangements are available online on <http://www.om.math.ethz.ch>.

# Chapter 0

## An Introduction to Oriented Matroids

### 0.1 A First Tour of Oriented Matroids

*Oriented matroids* can be viewed as an axiomatic combinatorial abstraction of geometric structures such as real hyperplane arrangements, convex polytopes, or point configurations in the Euclidean space. This abstraction reflects properties like linear dependencies, facial relationship, convexity, duality, and optimization issues, and by this oriented matroids have become an indispensable tool in discrete and computational geometry. Furthermore, the theory of oriented matroids has connections and applications to many areas of mathematics. A most comprehensive presentation can be found in the monograph of Björner, Las Vergnas, Sturmfels, White, and Ziegler [BLVS<sup>+</sup>99]. For the present thesis the introduction of the following pages will be sufficient. Readers who are already familiar with oriented matroids may read this chapter in parts; later chapters will refer to this Chapter 0.

We start this first tour of oriented matroids with a look at the *name*. The notion “matroid” was first used by Whitney [Whi35], created from “matrix” by adding the suffix “-oid”, hence meaning “resembling of a matrix” or “having the form of a matrix”. Let us consider the following matrix:

$$A = \begin{pmatrix} 0 & 0 & 1 & -1 \\ 1 & 0 & 0 & 0 \\ 1 & 1 & 1 & 1 \end{pmatrix}$$

There are several ways to see the matroid structure defined by  $A$ . One way is to consider the four column vectors

$$A_1 = \begin{pmatrix} 0 \\ 1 \\ 1 \end{pmatrix}, A_2 = \begin{pmatrix} 0 \\ 0 \\ 1 \end{pmatrix}, A_3 = \begin{pmatrix} 1 \\ 0 \\ 1 \end{pmatrix}, A_4 = \begin{pmatrix} -1 \\ 0 \\ 1 \end{pmatrix}$$

as vectors in  $\mathbb{R}^3$  and study their linear (in-)dependence as follows: the linear subspace generated by  $A_3$  and  $A_4$  contains  $A_2$ , but not  $A_1$ ; in other words,  $A_1$  is linear independent

from  $\{A_3, A_4\}$ , but not  $A_2$ . We call the index set  $\{2, 3, 4\}$  a *closed subset* or a *flat*. The set  $\mathcal{A}$  of all flats, in the case of our example

$$\mathcal{A} = \{\emptyset, \{1\}, \{2\}, \{3\}, \{4\}, \{1, 2\}, \{1, 3\}, \{1, 4\}, \{2, 3, 4\}, \{1, 2, 3, 4\}\},$$

defines a matroid (see also Section 0.3). For every flat  $X \in \mathcal{A}$  different from the full index set  $E := \{1, 2, 3, 4\}$  the subspace spanned by the vectors  $A_e, e \in X$ , is contained in some 2-dimensional subspace  $H_X$  of  $\mathbb{R}^3$ . This hyperplane  $H_X$  can be chosen such that  $A_e \in H_X$  if and only if  $e \in X$  (in general there are many choices for  $H_X$ ). Obviously  $H_X$  can be described by a normal vector  $x \in \mathbb{R}^3$ . Then  $e \in X$  if and only if  $x$  and  $A_e$  are orthogonal. If we define  $y^0 := \{e \mid y_e = 0\}$  for a vector  $y$ , then the above considerations lead to

$$\mathcal{A} = \{(A^T x)^0 \mid x \in \mathbb{R}^3\}$$

(note that  $E$  corresponds to  $x$  being the zero vector). This description of  $\mathcal{A}$ , i.e., of the matroid, is easily extended to an *oriented* abstraction of the spacial dependencies of  $A_1, \dots, A_4$ : For every hyperplane, i.e., for every  $x \in \mathbb{R}^3$ , we also consider for  $A_e^T x \neq 0$  whether  $A_e^T x < 0$  or  $A_e^T x > 0$ , i.e., whether  $\text{sign}(A_e^T x) = -$  or  $\text{sign}(A_e^T x) = +$ . Defining sign vectors  $\text{sign}(y)$  componentwise, the set of sign vectors

$$\mathcal{F}(A) = \{\text{sign}(A^T x) \mid x \in \mathbb{R}^3\}$$

gives a description of all these “oriented dependencies” of the column vectors of  $A$ . We call  $(E, \mathcal{F}(A))$  *the oriented matroid defined by  $A$*  and a sign vector in  $\mathcal{F}(A)$  a *covector*. For the example of the matrix  $A$  given above, Table 0.1 shows the complete list of covectors in  $\mathcal{F}(A)$ , grouped together by dimension of the linear subspaces defined by the corresponding flats.

Dimension 0		Dimension 1		Dimension 2		Dim. 3
++--	--+-	0+-+	0-+-	00-+	00+-	0000
-+-+	+--+	0--+	0++-	0+0+	0-0-	
+--+	-++-	+0-+	-0+-	0++0	0--0	
---+	++++	-0-+	+0+-	+000	-000	
++++	-----	0++++	0-----			
-++++	+-----	++0+	--0-			
		-+0+	+--0-			
		+++0	---0			
		-++0	+--0			

Table 0.1: List of covectors in  $\mathcal{F}(A)$

Instead of studying the relative positions of the vectors  $A_e$  w.r.t. oriented hyperplanes which are defined by normal vectors  $x \in \mathbb{R}^3$ , we consider now the *central hyperplane arrangement*  $\{H_1, \dots, H_4\}$  defined by taking  $A_e$  as the normal vector of  $H_e$  for  $e \in E$ . Each hyperplane  $H_e$  is oriented, where  $A_e$  points to the  $+$  side. Then every point  $x \in \mathbb{R}^3$  defines a sign vector  $X \in \{-, +, 0\}^E$  by its relative position in the arrangement, i.e.,

$X_e = 0$  if  $x$  is contained in  $H_e$ ,  $X_e = +$  if  $x$  is on the  $+$  side of  $H_e$ , and  $X_e = -$  otherwise. Obviously  $X_e = \text{sign}(A_e^T x)$ , and the set of all sign vectors obtained in this way is exactly the set  $\mathcal{F}(A)$  of covectors as defined above.

Before we illustrate sets of covectors like  $\mathcal{F}(A)$  further using other geometrical models, we have closer look at the properties of  $\mathcal{F}(A)$ . It is obvious that for  $x$  being the zero vector,  $\mathbf{0} := (0 \dots 0) = \text{sign}(A^T x) \in \mathcal{F}(A)$ . Furthermore, replacing any  $x$  by  $-x$  shows that  $X \in \mathcal{F}(A)$  implies  $-X \in \mathcal{F}(A)$ , where  $-X$  denotes the sign vector obtained by reversing all signs in the obvious way. Slightly more advanced, we may consider linear combinations of vectors  $x, y$ . For arbitrary small  $\varepsilon$  consider  $z := x + \varepsilon y$  and the corresponding sign vectors  $X := \text{sign}(A^T x)$ ,  $Y := \text{sign}(A^T y)$ , and  $Z := \text{sign}(A^T z)$ , then for  $e \in E$

$$Z_e = \text{sign}(A^T z)_e = \text{sign}(A^T x + \varepsilon A^T y)_e = \begin{cases} \text{sign}(A^T x)_e = X_e & \text{if } X_e \neq 0, \\ \text{sign}(A^T y)_e = Y_e & \text{otherwise.} \end{cases}$$

This proves that for  $X, Y \in \mathcal{F}(A)$  also the sign vector  $Z = X \circ Y$  belongs to  $\mathcal{F}(A)$ , where we define  $Z := X \circ Y$  by  $Z_e = X_e$  if  $X_e \neq 0$  and  $Z_e = Y_e$  otherwise. We call  $X \circ Y$  the *composition* of  $X$  and  $Y$ . Finally consider two vectors  $x, y$  which are separated by (at least) one hyperplane  $H_e$ , i.e.,  $X_e = -Y_e \neq 0$  for the corresponding two sign vectors  $X, Y \in \mathcal{F}$ . We say that  $e$  *separates*  $X$  and  $Y$  and denote by  $D(X, Y)$  the set of all elements which separate  $X$  and  $Y$ . Let  $z$  denote the intersection point of  $H_e$  and the line connecting  $x$  and  $y$ . Then the corresponding sign vector  $Z := \text{sign}(A^T z) \in \mathcal{A}$  satisfies  $Z_e = 0$  and  $Z_f = (X \circ Y)_f$  for all non-separating elements  $f$ . Let us list all the properties which we found satisfied by  $\mathcal{F} := \mathcal{F}(A)$ :

(F0)  $\mathbf{0} \in \mathcal{F}$ .

(F1) If  $X \in \mathcal{F}$  then also  $-X \in \mathcal{F}$ .

(F2) If  $X, Y \in \mathcal{F}$  then also  $X \circ Y \in \mathcal{F}$ .

(F3) If  $X, Y \in \mathcal{F}$  and  $e \in D(X, Y)$  then there exists  $Z \in \mathcal{F}$  such that  $Z_e = 0$  and  $Z_f = (X \circ Y)_f$  for all  $f \in E \setminus D(X, Y)$ .

In the theory of oriented matroids the properties (F0) to (F3) play the role of *axioms*: An *oriented matroid* is defined as a pair  $\mathcal{M} = (E, \mathcal{F})$  of a finite set  $E$  and  $\mathcal{F} \subseteq \{-, +, 0\}^E$  which satisfies (F0) to (F3). The notion of oriented matroids was introduced in the late seventies independently by Bland and Las Vergnas [BLV78] and by Folkman and Lawrence [FL78]. In fact, there are several equivalent axiom systems of oriented matroids some of which we will introduce in the following sections.

An immediate question is whether all oriented matroids (as defined by (F0) to (F3)) have a *realization* (as given by a matrix  $A$  or a central hyperplane arrangement). The answer was found to be that this is not the case, and it is known that the problem to decide whether an oriented matroid is realizable (also called *linear*) or not is *NP*-hard [Mnë88, Sho91]. As the axioms of oriented matroids can be checked in polynomial time, there is not polynomial characterization of realizable oriented matroids unless  $P = NP$ . By this, the

abstraction of oriented matroids is of great importance also for the study of the realizable cases. Furthermore, the realization problem is decidable and there are practical methods which work satisfactory for smaller instances, at least in the uniform case [RG92].

Will see in the following how oriented matroids can be illustrated using a geometric (or topological) model. The intersection of a central hyperplane arrangement  $\{H_e \mid e \in E\}$  with the unit ball centered at origin defines a *sphere arrangement*  $\mathcal{S} = \{S_e \mid e \in E\}$ , where again every sphere  $S_e$  is oriented (as induced by the corresponding hyperplane  $H_e$ ). The sphere arrangement defined by the above example is illustrated in Figure 0.1. The

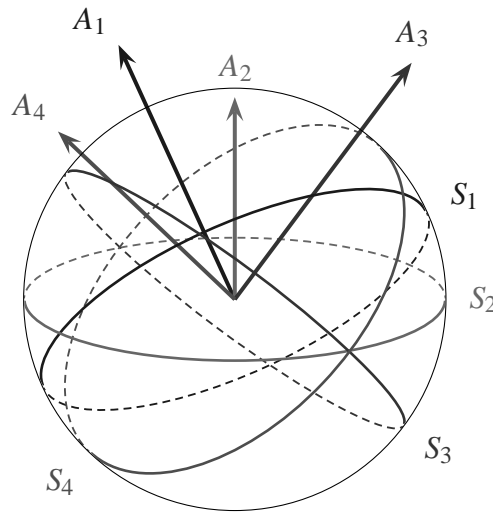

Figure 0.1: Sphere arrangement

sphere arrangement  $\mathcal{S}$  induces a cell complex  $\mathcal{K}$  on the unit sphere  $S^d$ . Every point  $x$  on  $S^d$  defines a sign vector  $X \in \{-, +, 0\}^E$  by  $X_e = 0$  if  $x$  is on  $S_e$ , otherwise  $X_e = +$  (or  $X_e = -$ ) if  $x$  is on the  $+$  side (or  $-$  side, respectively) of  $S_e$ ; let  $\mathcal{F}(\mathcal{S})$  denote the set of all these sign vectors. It is not difficult to see that if  $\mathcal{S}$  is induced by a central hyperplane arrangement defined by a matrix  $A$  as above, then  $\mathcal{F}(\mathcal{S}) = \mathcal{F}(A) \setminus \{\mathbf{0}\}$ . Hence sphere arrangements give again an illustration of sets of covectors  $\mathcal{F}(A)$  or  $\mathcal{F}(\mathcal{S})$ . More general, a *pseudosphere arrangement*  $\mathcal{S} = \{S_e \mid e \in E\}$  in the Euclidean space  $\mathbb{R}^{d+1}$  is a collection of  $(d-1)$ -dimensional topological spheres on the  $d$ -dimensional unit sphere  $S^d$ , where every sphere  $S_e$  is oriented (i.e.,  $S_e$  has a  $+$  side and a  $-$  side) and the intersection properties of the topological spheres are as in a (linear) sphere arrangement, e.g., the intersection of any number of spheres is again a sphere and the intersection of an arbitrary collection of closed sides is either a sphere or a ball (for details see Definition 5.1.3 in [BLVS<sup>+</sup>99]). As for (linear) sphere arrangements, a pseudosphere arrangement  $\mathcal{S}$  induces a cell complex  $\mathcal{K}$  and a set of sign vectors  $\mathcal{F}(\mathcal{S})$  which satisfies (F0) to (F3). The so-called *Topological Representation Theorem* of Folkman and Lawrence [FL78] and its simplification by Mandel [Man82] assure that also the converse is true: For every set  $\mathcal{F}$  of sign vectors which satisfies (F0) to (F3), there exists a pseudosphere arrangement  $\mathcal{S}$  such that  $\mathcal{F}(\mathcal{S}) = \mathcal{F} \setminus \{\mathbf{0}\}$ . We illustrate in Figure 0.2 how a pseudosphere arrangement may look (again for the same set of covectors as above).

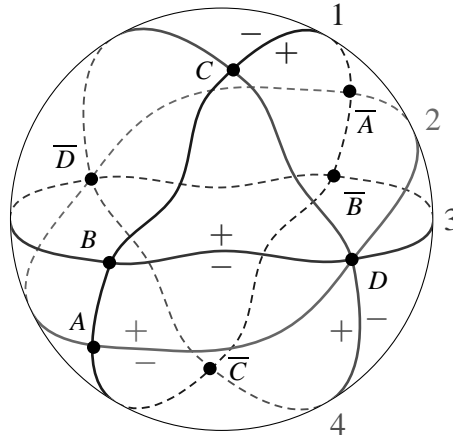

Figure 0.2: Pseudosphere arrangement

Sphere arrangements (or pseudosphere arrangements) of corresponding cell complexes  $\mathcal{K}$  are very helpful illustrations of many considerations concerning oriented matroids. Obviously there is a one-to-one correspondence between the cells in  $\mathcal{K}$  and the sign vectors in  $\mathcal{F}(\mathcal{S})$ . We list this correspondence for our example in Table 0.2 (see Figure 0.2 for the naming of the cells). The relationship of faces in the cell complex  $\mathcal{K}$  can be read easily

Dimension 0				Dimension 1				Dimension 2							
A	0	0	-+	$\bar{A}$	0	0	+-	ABD	++-+	$\overline{ABD}$	--+-	AB $\bar{D}$	-+-+	$\overline{AB\bar{D}}$	+--+
B	0	+0	+	$\bar{B}$	0	-0	-	AC $\bar{D}$	+--+	$\overline{AC\bar{D}}$	-++-	BCD	++++	$\overline{BCD}$	----
C	0	++0	0	$\bar{C}$	0	--0	0	BC $\bar{D}$	-+++	$\overline{BC\bar{D}}$	+---	CD	+++0	$\overline{CD}$	---0
D	+000	$\bar{D}$	-000	AD	+0-	$\bar{AD}$	-0+-	AD	-0+-	$\overline{AD}$	+0+-	C $\bar{D}$	-++0	$\overline{C\bar{D}}$	+--0
				A $\bar{D}$	-0-	$\overline{A\bar{D}}$	+0+-	BD	++0+	$\bar{BD}$	--0-				
				BC	0+++	$\bar{BC}$	0---	B $\bar{D}$	-+0+	$\overline{B\bar{D}}$	+0-				
				BD	++0+	$\bar{BD}$	--0-	CD	+++0	$\bar{CD}$	---0				
				B $\bar{D}$	-+0+	$\overline{B\bar{D}}$	+0-	C $\bar{D}$	-++0	$\overline{C\bar{D}}$	+--0				
				CD	+++0	$\bar{CD}$	---0								
				C $\bar{D}$	-++0	$\overline{C\bar{D}}$	+--0								

Table 0.2: Faces and corresponding sign vectors

from the sign patterns in  $\mathcal{F}$ : e.g., we see that  $AB$  is a face of  $ABD$  since all nonzero signs of  $(0 + - +)$  are the same in  $(+ + - +)$ , the covectors corresponding to  $AB$  and  $ABD$ . This gives rise to the following definition: For two covectors  $X, Y \in \mathcal{F}$  we say that  $X$  is a face of  $Y$  or  $X$  conforms to  $Y$  (denoted by  $X \leq Y$ ) if  $X_e \neq 0$  implies  $X_e = Y_e$ . The set  $\mathcal{F}$  ordered by the facial relation  $\leq$ , with the zero vector  $\mathbf{0}$  as smallest element and an additional artificial greatest element  $\mathbf{1}$ , forms a lattice  $\hat{\mathcal{F}}$ , the so-called *big face lattice* (see Figure 0.3). The big face lattice  $\hat{\mathcal{F}}$  coincides with the face lattice of the cell complex  $\mathcal{K}$ , and if we define  $\text{rank}(X)$  by the height of a face  $X$  in  $\hat{\mathcal{F}}$ , then  $\text{rank}(X) - 1$  equals the dimension of the corresponding facet in  $\mathcal{S}$ .

The big face lattice  $\hat{\mathcal{F}}$  can be considered as a representation of the *combinatorial type* of

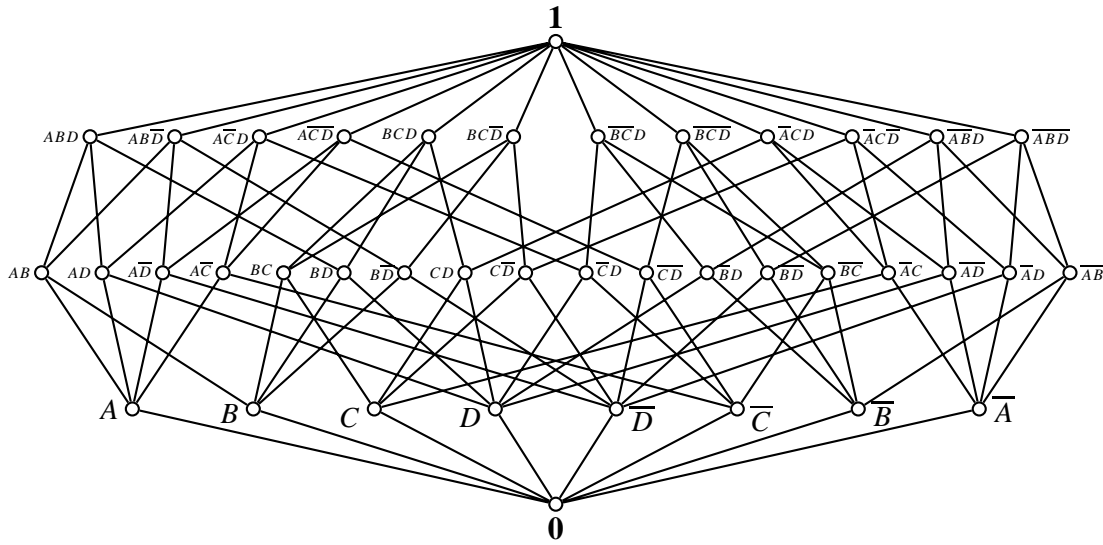

Figure 0.3: The big face lattice  $\hat{\mathcal{F}}$

$\mathcal{K}$  or the corresponding oriented matroid. Renaming (or *relabeling*) the elements of  $E$ , or *reorienting* the elements, i.e., interchanging  $+$  and  $-$  side, does not affect the face lattice. This remains true if we consider the notion *relabeling* in a more general sense than usual: elements  $e, f$  which are identical (i.e.,  $X_e = X_f$  for all  $X \in \mathcal{F}$ ) can be replaced by one representing element, or similarly elements can be doubled; furthermore one may delete (or introduce) elements  $e$  which are constantly 0 (i.e.,  $X_e = 0$  for all  $X \in \mathcal{F}$ ). We will see later (in Chapter 1) that the big face lattice is sufficient to reconstruct an oriented matroid up to labeling and orientation. In formal language, relabeling of an oriented matroid  $\mathcal{M}$  defines its *relabeling class*  $LC(\mathcal{M})$ , reorientation its *reorientation class*  $OC(\mathcal{M})$ , and relabeling and reorientation its *isomorphism class*  $IC(\mathcal{M})$ . Two oriented matroids are isomorphic if and only if they have the same face lattices.

We have seen that matrices define not only matroids but also oriented matroids, and from this we developed geometric interpretations and models such as central hyperplane arrangements and sphere arrangements, which stand for realizable oriented matroids. Furthermore, every oriented matroid can be represented by some pseudosphere arrangement. There are more geometric objects such as point configurations or affine hyperplane arrangements (see also the last two chapters of this thesis) whose combinatorial abstractions lead to (realizable) oriented matroids. In fact, in the history of oriented matroids such objects which we used for illustration or as a representation of oriented matroids were the starting point and the motivation for the definition and investigation of axiom systems such as the covector axioms (F0) to (F3). These investigations have shown that many of the objects of study have mutual interpretations under which axiom systems become equivalent. By this, seemingly different objects have been found to be part of one theory, which we call *the theory of oriented matroids*. We will develop in the following some aspects of this theory, also showing several axiom systems and their equivalence.



## 0.2 Covector Axioms

The combinatorial abstractions of the geometric examples in the previous Section 0.1 showed a number of elementary properties. In this section we take such elementary properties as the set of axioms of the theory of oriented matroids which will be developed in the following. The axioms which we use in this section for the definition of oriented matroids have been studied jointly by Edmonds, Fukuda, and Mandel [Fuk82, Man82] which proved their equivalence with the cocircuit axioms [BLV78]. We have chosen the other direction and will introduce cocircuit axioms later (see Section 0.6).

Let  $E$  denote a finite set, e.g.,  $E = \{1, 2, \dots, n\}$ . We call  $E$  *the ground set* and  $e \in E$  *an element*. In the examples of Section 0.1 these elements correspond to the hyperplanes in central hyperplane arrangements or spheres in sphere arrangements. As before, a vector  $X \in \{-, +, 0\}^E$  is called *a sign vector* on  $E$ ; we may not mention the ground set  $E$  if it is determined from the context, e.g., we denote by  $\mathbf{0} := (0 \ 0 \ \dots \ 0) \in \{0\}^E$  the sign vector with all signs equal to zero. For  $S \subseteq E$  we denote by  $X_S$  the sign vector in  $\{-, +, 0\}^S$  obtained from  $X$  by  $(X_S)_e := X_e$  for  $e \in S$ , and similarly  $X \setminus S$  denotes the subvector of  $X$  on  $E \setminus S$ . We will write  $X \setminus e$  for  $X \setminus \{e\}$  etc. where convenient. The *negative*  $-X$  of a sign vector  $X$  is defined by  $(-X)_e := -X_e$  for  $e \in E$ , where  $-(-+0) = (+-0)$ . For  $S \subseteq E$  let  $\overline{S}X$  denote the sign vector on  $E$  with  $(\overline{S}X)_S = -X_S$  and  $(\overline{S}X) \setminus S = X \setminus S$ . The *support* of a sign vector  $X \in \{-, +, 0\}^E$  is the set  $\underline{X} := \{e \in E \mid X_e \neq 0\}$ , and its complement  $X^0 := \{e \in E \mid X_e = 0\}$  is called the *zero support* of  $X$ . Furthermore call the sets  $X^+ := \{e \in E \mid X_e = +\}$  and  $X^- := \{e \in E \mid X_e = -\}$  the *positive support* and the *negative support*, respectively. For two sign vectors  $X$  and  $Y$  on  $E$  we define the *composition* of  $X$  and  $Y$  (denoted by  $X \circ Y$ ) as before by

$$(X \circ Y)_e := \begin{cases} X_e & \text{if } X_e \neq 0, \\ Y_e & \text{otherwise,} \end{cases}$$

so, e.g.,  $(---+++000) \circ (-+0-+0-+0) = (---+++--+0)$ . Note that the composition  $\circ$  is associative, i.e.,  $(X \circ Y) \circ Z = X \circ (Y \circ Z)$ , but not symmetric:  $X \circ Y = Y \circ X$  if and only if  $D(X, Y) := \{e \in E \mid X_e = -Y_e \neq 0\} = \emptyset$ ; for  $e \in D(X, Y)$ , we say that  $X$  and  $Y$  *disagree in  $e$*  or  $e$  *separates  $X$  and  $Y$* .

The following definition of an oriented matroid was already given in Section 0.1:

**0.2.1 Definition (Covector Axioms of Oriented Matroids)** An *oriented matroid*  $\mathcal{M}$  is a pair  $(E, \mathcal{F})$  of a finite set  $E$  and a set  $\mathcal{F} \subseteq \{-, +, 0\}^E$  of sign vectors (called *covectors*) for which the following *covector axioms* (F0) to (F3) are valid:

(F0)  $\mathbf{0} \in \mathcal{F}$ .

(F1) If  $X \in \mathcal{F}$  then  $-X \in \mathcal{F}$ . (symmetry)

(F2) If  $X, Y \in \mathcal{F}$  then  $X \circ Y \in \mathcal{F}$ . (composition)

(F3) For all  $X, Y \in \mathcal{F}$  and  $e \in D(X, Y)$   
 there exists  $Z \in \mathcal{F}$  such that  
 $Z_e = 0$  and  
 $Z_f = (X \circ Y)_f$  for all  $f \in E \setminus D(X, Y)$ . (covector elimination)

The facial relationship (e.g., in sphere arrangements) is abstracted as follows: For two sign vectors  $X, Y \in \{-, +, 0\}^E$  we say that  $X$  conforms to  $Y$  (or  $X$  is a face of  $Y$ ), denoted by  $X \preceq Y$ , if  $X_e \neq 0$  implies  $X_e = Y_e$ , e.g.,  $(0 + - 0)$  conforms to  $(0 + - +)$  but not to  $(0 + + +)$ ; in addition we write  $X \prec Y$  if  $X \preceq Y$  and  $X \neq Y$ .

The covector elimination axiom (F3) can be replaced by weaker and stronger variants. Actually, there are many such variations of the axioms known from the literature, and they are very helpful for the proofs of the statements which follow later. Our formulations (F3<sup>c</sup>) and (F3<sup>w</sup>) follow Fukuda [Fuk82, Fuk00b] and are also closely related to the so-called *Y-approximation of X* [Man82] (see also Proposition 3.7.10 in [BLVS<sup>+</sup>99]) and to the *strong vector elimination* [BLV78, Man82] (see also Theorem 3.7.5 in [BLVS<sup>+</sup>99]), respectively.

**0.2.2 Proposition** *Let  $\mathcal{F} \subseteq \{-, +, 0\}^E$  be a set of sign vectors satisfying (F0), (F1), and (F2). Then the three statements (F3), (F3<sup>c</sup>), and (F3<sup>w</sup>) are equivalent, where*

(F3<sup>c</sup>) For all  $X, Y \in \mathcal{F}$  and  $\emptyset \neq S \subseteq D(X, Y)$   
 there exist  $e \in S$  and  $Z \in \mathcal{F}$  such that  
 $Z_e = 0$  and  
 $Z_S \preceq X_S$  and  
 $Z_f = (X \circ Y)_f$  for all  $f \in E \setminus D(X, Y)$ . (conformal elimination)

and

(F3<sup>w</sup>) For all  $X, Y \in \mathcal{F}$  and  $e \in D(X, Y)$  and  $f \in \underline{X} \setminus D(X, Y)$   
 there exists  $Z \in \mathcal{F}$  such that  
 $Z_e = 0$  and  
 $Z_f = X_f$  and  
 $Z_g \in \{X_g, Y_g, 0\}$  for all  $g \in E$ . (weak elimination)

**Proof** Let  $\mathcal{F} \subseteq \{-, +, 0\}^E$  be a set of sign vectors satisfying (F0), (F1), and (F2). We will show (F3)  $\Rightarrow$  (F3<sup>c</sup>)  $\Rightarrow$  (F3<sup>w</sup>)  $\Rightarrow$  (F3), where the implication (F3<sup>c</sup>)  $\Rightarrow$  (F3<sup>w</sup>) is obvious with  $S = \{e\}$ .

Assume that (F3) is satisfied and show (F3<sup>c</sup>). Let be  $X, Y \in \mathcal{F}$  and  $\emptyset \neq S \subseteq D(X, Y)$  and prove the claim by induction on  $|S|$ : For  $|S| = 1$ , (F3<sup>c</sup>) follows directly from (F3). For the inductive step assume  $|S| > 1$  and that (F3<sup>c</sup>) is satisfied for all  $\emptyset \neq S' \subseteq D(X, Y)$  with  $|S'| < |S|$ . Choose any  $e \in S$  and set  $S' := S \setminus e$ . By induction there exists  $Z' \in \mathcal{F}$  such that  $Z'_{S'} \preceq X_{S'}$  and  $Z'_f = (X \circ Y)_f$  for all  $f \in E \setminus D(X, Y)$ . If  $e \notin D(X, Z')$  then  $Z := Z'$  is sufficient to prove (F3<sup>c</sup>). Otherwise apply (F3) to  $X, Z'$ , and  $e$ : There exists  $Z \in \mathcal{F}$  such that  $Z_e = 0$  and  $Z_f = (X \circ Z')_f$  for all  $f \in E \setminus D(X, Z')$ . Remark that  $Z_S \preceq X_S$  follows by  $Z_e = 0 \preceq X_e$  and  $Z_{S'} = X_{S'}$  (since  $Z'_{S'} \preceq X_{S'}$  implies  $S' \subseteq E \setminus D(X, Z')$ , therefore  $Z_{S'} = (X \circ Z')_{S'} = X_{S'}$ , where the last equality follows from  $S' \subseteq D(X, Y) \subseteq \underline{X}$ ). Finally,  $f \in E \setminus D(X, Y)$  implies that  $Z'_f = (X \circ Y)_f$ , therefore also  $f \in E \setminus D(X, Z')$  and  $Z_f = (X \circ Z')_f = (X \circ Y)_f$ .

Assume that (F3<sup>w</sup>) is satisfied and show (F3). Let be  $X, Y \in \mathcal{F}$  and  $e \in D := D(X, Y)$ . For all  $f \in \underline{X} \setminus D$  let be  $Z^f \in \mathcal{F}$  such that  $Z^f_e = 0$  and  $Z^f_f = X_f$  and for all  $g \in E$

is  $Z_g^f \in \{X_g, Y_g, 0\}$ . Similarly for  $f \in \underline{Y} \setminus D$  let be  $\tilde{Z}^f \in \mathcal{F}$  such that  $\tilde{Z}_e^f = 0$  and  $\tilde{Z}_f^f = Y_f$  and  $\tilde{Z}_g^f \in \{X_g, Y_g, 0\}$  for all  $g \in E$ . Let  $Z \in \mathcal{F}$  denote a covector which is the composition (in some arbitrary order) of all these  $Z^f$  and  $\tilde{Z}^f$ ; if  $\underline{X} \subseteq D$  and  $\underline{Y} \subseteq D$  then  $X = -Y$  and  $Z := \mathbf{0}$  is sufficient. Obviously  $Z_e = 0$ . Consider  $g \in E \setminus D$  and  $f \in \underline{X} \setminus D$ . If  $Z_g^f \neq (X \circ Y)_g$  then  $Z_g^f = 0$ . Similarly for  $f \in \underline{Y} \setminus D$ , if  $\tilde{Z}_g^f \neq (X \circ Y)_g$  then  $\tilde{Z}_g^f = 0$ . For  $g \in \underline{X} \cup \underline{Y} \setminus D$  this implies  $Z_g = Z_g^g = X_g = (X \circ Y)_g$  or  $Z_g = \tilde{Z}_g^g = Y_g = (X \circ Y)_g$ . For  $g \in X^0 \cap Y^0$  we conclude  $Z_g^f = 0$  for all  $f \in \underline{X} \setminus D$  and  $\tilde{Z}_g^f = 0$  for all  $f \in \underline{Y} \setminus D$ , hence  $Z_g = (X \circ Y)_g = 0$  for all  $g \in E \setminus D$ . ■

## 0.3 Matroids

We have started the first tour of oriented matroids in Section 0.1 with matroids, which can be viewed as an abstraction of linear dependencies of vectors. This section introduces axioms of matroids and discusses fundamental notions such as independent sets, bases, and rank in matroids. It will be straightforward to extend these notions to the context of oriented matroids as every oriented matroid defines a matroid when omitting the orientations of signs. A more comprehensive introduction to matroids can be found in the monographs of Welsh [Wel76] and Oxley [Oxl92].

**0.3.1 Definition (Matroid Flat Axioms)** A *matroid*  $M$  is a pair  $(E, \mathcal{A})$  of a finite set  $E$  and a set  $\mathcal{A} \subseteq 2^E$  of subsets of  $E$  (called *flats* or *closed sets*) for which the following *flat axioms* (M1) to (M3) are valid:

(M1)  $E \in \mathcal{A}$ .

(M2) If  $X, Y \in \mathcal{A}$  then  $X \cap Y \in \mathcal{A}$ . (intersection)

(M3) For all  $X, Y \in \mathcal{A}$ ,  $e \in E \setminus (X \cup Y)$ , and  $f \in X \setminus Y$  there exists  $Z \in \mathcal{A}$  such that  $e \in Z$ ,  $f \notin Z$ , and  $X \cap Y \subseteq Z$ . (exchange)

The matroid flat axioms are satisfied by any sets  $\mathcal{A}$  as defined by matrices  $A$  in Section 0.1: a flat  $X \in \mathcal{A}$  is a subset of column indices of a given matrix  $A$  such that the subspace spanned by the column vectors  $A_e$ ,  $e \in X$ , does not contain any  $A_f$  with  $f \notin X$ .

The study of the relation of oriented matroids and their underlying matroids is as old as the notion of oriented matroids (e.g., see [FL78]):

**0.3.2 Proposition** Let  $\mathcal{M} = (E, \mathcal{F})$  be an oriented matroid. Then  $(E, \{X^0 \mid X \in \mathcal{F}\})$  is a matroid.

**Proof** Let  $\mathcal{M} = (E, \mathcal{F})$  be an oriented matroid and set  $\mathcal{A} := \{X^0 \mid X \in \mathcal{F}\}$ . It is obvious that (M1) and (M2) follow directly from (F0) and (F2). In order to show (M3) let be  $X, Y \in \mathcal{F}$  such that there exist  $e \in E \setminus (X^0 \cup Y^0)$  and  $f \in X^0 \setminus Y^0$ . We can assume that  $X_e = -Y_e \neq 0$  (otherwise replace  $Y$  by  $-Y$ ), so  $e \in D(X, Y)$  and  $f \in E \setminus D(X, Y)$ . By (F3) there exists  $Z \in \mathcal{F}$  such that  $Z_e = 0$  and  $Z_g = (X \circ Y)_g$  for all  $g \in E \setminus D(X, Y)$ , especially  $Z_f = (X \circ Y)_f = Y_f \neq 0$  and  $X^0 \cap Y^0 \subseteq Z^0$ . This shows that  $Z^0 \in \mathcal{A}$  satisfies the flat axiom (M3) for  $X^0, Y^0, e$ , and  $f$ . ■

**0.3.3 Definition (Underlying Matroid)** Let  $\mathcal{M} = (E, \mathcal{F})$  be an oriented matroid and set  $\mathcal{A} := \{X^0 \mid X \in \mathcal{F}\}$ . Then we call the matroid  $(E, \mathcal{A})$  *the underlying matroid of  $\mathcal{M}$* , denoted by  $\underline{\mathcal{M}}$ .

A matroid is called *orientable* if it is the underlying matroid of an oriented matroid. There exist matroids which are not orientable, and the question whether a matroid is orientable or not is *NP*-complete [RG99]; for details we refer to Sections 6.6 and 7.9 of [BLVS<sup>+</sup>99].

The first fundamental notion of the theory of matroids is the *span* operation. For matroids as introduced in Section 0.1, where a given matrix  $A$  defines a set of flats  $\mathcal{A}$ , the span of a some subset  $S \subseteq E$  of column indices is the set of indices whose corresponding column vectors are contained in the subspace spanned by the vectors according to  $S$ .

**0.3.4 Definition (Span)** Let  $M = (E, \mathcal{A})$  be a matroid and  $S \subseteq E$  a subset of  $E$ . The set

$$\text{span}_M(S) := \bigcap_{\substack{X \in \mathcal{A} \\ S \subseteq X}} X$$

is called *the span of  $S$  in  $M$* . Usually, if  $M$  is defined from the context, we write  $\overline{S}$  for  $\text{span}_M(S)$ .

**0.3.5 Lemma** Let  $M = (E, \mathcal{A})$  be a matroid and  $S \subseteq E$ . Then

- (i)  $\overline{S} \in \mathcal{A}$ , (flat)
- (ii)  $S \subseteq \overline{S}$ , (hull)
- (iii)  $\overline{\overline{S}} = \overline{S}$ , and (closure)
- (iv)  $\overline{S} \subseteq \overline{R}$  for all  $S \subseteq R \subseteq E$ . (monotonicity)

**Proof** Let  $M = (E, \mathcal{A})$  be a matroid. Properties (i) and (ii) follow by definition, where for (i) also the matroid intersection axiom (M2) is important. For (iii) observe that by (i) and the definition follows  $\overline{\overline{S}} \subseteq \overline{S}$ , where (ii) implies  $\overline{S} \subseteq \overline{\overline{S}}$ . Finally consider  $S \subseteq R \subseteq E$ : If  $X \in \mathcal{A}$  satisfies  $R \subseteq X$  then also  $S \subseteq X$ , hence by definition  $\overline{S} \subseteq \overline{R}$ . ■

The definition of the span operation can be used for the definition of *independent sets* and *bases* of matroids. Again, using the relation of matrices and matroids as discussed before, independent sets and bases of column vectors nicely illustrate the corresponding notions in matroids.

**0.3.6 Definition (Independent Sets, Bases)** Let  $M = (E, \mathcal{A})$  be a matroid. A set  $S \subseteq E$  is called *independent* or *an independent set of  $M$*  if  $\overline{S \setminus e} \neq \overline{S}$  for all  $e \in S$ . For any set  $S \subseteq E$  we call a subset  $B \subseteq S$  *a basis of  $S$*  if  $B$  is a maximal independent subset of  $S$ . A basis of  $E$  is also called *a basis of  $M$* , and the set of all bases of  $M$  is denoted by  $\mathcal{B}$ .

**0.3.7 Lemma** Let  $M = (E, \mathcal{A})$  be a matroid and  $S \subseteq E$ .

- (i)  $S$  is an independent set of  $M$  if and only if  $\overline{S \setminus e} \subseteq \overline{S} \setminus e$  for all  $e \in S$ .
- (ii)  $S$  is an independent set of  $M$  if and only if for every  $e \in S$  there exists  $X \in \mathcal{A}$  such that  $S \setminus e \subseteq X \not\ni e$ .
- (iii) Every subset of an independent set is independent.
- (iv) Let  $S$  be an independent set and  $e \in E \setminus S$ . Then  $S \cup e$  is independent if and only if  $e \notin \overline{S}$ .
- (v) For  $S \in \mathcal{A}$  and  $B$  an independent subset of  $S$ ,  $B$  is a basis of  $S$  if and only if  $\overline{B} = S$ .
- (vi) There exists a basis  $B$  of  $\overline{S}$  such that  $B \subseteq S$ . For any  $S \subseteq T \subseteq E$  there exists a basis  $B'$  of  $\overline{T}$  such that  $B \subseteq B' \subseteq T$ .

**Proof** For (i) consider  $S \subseteq E$  and  $e \in S$ . The monotonicity of the span operator (see Lemma 0.3.5) implies  $\overline{S \setminus e} \subseteq \overline{S}$ , and furthermore  $e \in \overline{S \setminus e}$  would imply  $S \subseteq \overline{S \setminus e}$  and hence  $\overline{S} = \overline{S \setminus e}$ . Therefore the claim follows by the definition of an independent set.

For (ii) consider (i) and the definition of an independent set: If  $S$  is independent then  $X := \overline{S \setminus e}$  is sufficient; otherwise  $\overline{S \setminus e} = \overline{S}$  for some  $e \in S$ , which contradicts the existence of  $X \in \mathcal{A}$  such that  $S \setminus e \subseteq X \not\ni e$ .

For (iii) consider  $R \subseteq S$ , where  $S$  is an independent set of  $M$ . Using (i) and Lemma 0.3.5,  $\overline{R \setminus e} \subseteq \overline{S \setminus e} \subseteq \overline{S} \setminus e$  for every  $e \in S$ , so  $\overline{R \setminus e} \subseteq \overline{R} \setminus e$  for every  $e \in R \subseteq S$ , i.e.,  $R$  is independent.

For the proof of (iv) let  $S$  be independent and  $e \in E \setminus S$ . If  $e \in \overline{S}$  then  $\overline{S \cup e} = \overline{S}$  (see Lemma 0.3.5 and the definition of the span), i.e.,  $S \cup e$  is not independent. Otherwise  $e \notin \overline{S}$ . Show that  $S \cup e$  is independent, i.e.,  $\overline{(S \cup e) \setminus f} \subseteq \overline{S \cup e} \setminus f$  for all  $f \in S \cup e$ . Obviously this is true for  $f = e$ , so consider  $f \in S$ . Because of  $f \notin \overline{S \setminus f}$  we can apply (M3) to  $X := \overline{S}$ ,  $Y := \overline{S \setminus f}$ ,  $e$ , and  $f$ : There exists  $Z \in \mathcal{A}$  such that  $e \in Z$ ,  $f \notin Z$ , and  $X \cap Y = \overline{S \setminus f} \subseteq Z$ . This implies  $\overline{(S \cup e) \setminus f} \subseteq Z \not\ni f$  and by this the claim.

Assume that  $S \in \mathcal{A}$  and  $B \subseteq S$  is an independent set. By Lemma 0.3.5  $\overline{B} \subseteq \overline{S} = S$ . (iv) implies that  $B$  can be extended within  $S$  to a larger independent set if and only if  $S \setminus \overline{B} \neq \emptyset$ , which proves (v).

The proof of (vi) follows by use of (iv): Set  $B^0 := \emptyset \subseteq S$ . If  $\overline{B^0} = \overline{S}$  then is  $B^0$  a basis of  $\overline{S}$  as  $B^0$  is obviously independent. Otherwise  $\overline{B^0} \subsetneq \overline{S}$ , so we can set  $B^1 := B^0 \cup e \subseteq S$  for some  $e \in S \setminus \overline{B^0}$ ;  $B^1$  is independent by (iv). If  $\overline{B^1} = \overline{S}$  then is  $B^1$  a basis of  $\overline{S}$ . Otherwise repeat the same argument: for  $i = 1, 2, \dots$  set  $B^{i+1} := B^i \cup e \subseteq S$  for any  $e \in S \setminus \overline{B^i}$ ; obviously this process has to stop for some  $i \leq |S|$ , then  $\overline{B^i} = \overline{S}$  and  $B := B^i$  is a basis of  $\overline{S}$ . If  $\overline{S} \neq \overline{T}$  we extend  $B$  in the same way to a basis  $B'$  of  $\overline{T}$ , and obviously  $B \subseteq B' \subseteq T$ . ■

In the proof of Lemma 0.3.7 (vi) a basis of a set  $S \subseteq E$  was constructed incrementally by extending an independent subset  $B^i$  of  $S$  by an arbitrary element  $e \in S \setminus \overline{B^i}$ . Such methods which incrementally construct a “solution” by augmenting a “partial solution”, namely by adding any element which satisfies some (simple) criterion, are called *greedy methods*. It is remarkable that problems which allow greedy methods can be characterized as having a matroid structure.

The following basis exchange property is important for the basis cardinality theorem, which will allow us to define the rank of a flat, furthermore it introduces an adjacency relation of bases and the corresponding operation to move from one basis to a neighboring basis, which is called a *pivot operation*. Basis adjacency is not only important in proofs (e.g., when we consider basis orientations in Section 0.9) but also for the design of *pivoting algorithms* (e.g., see [Bla77, Fuk82, FFL99]) as in the context of oriented matroid programming (Section 0.8).

**0.3.8 Proposition (Basis Exchange Property)** *Let  $M = (E, \mathcal{A})$  be a matroid,  $X \in \mathcal{A}$ , and  $B, B'$  bases of  $X$ . Then: For all  $e \in B \setminus B'$  there exists  $f \in B' \setminus B$  such that  $(B \setminus e) \cup f$  is a basis of  $X$ .*

**Proof** Let  $M = (E, \mathcal{A})$  be a matroid,  $X \in \mathcal{A}$ ,  $B, B'$  bases of  $X$ , and  $e \in B \setminus B'$ . Remark that  $e \notin \overline{B \setminus e}$  (see Lemma 0.3.7) and  $B' \not\subseteq \overline{B \setminus e}$  (otherwise  $X = B' \subseteq \overline{B \setminus e} \not\ni e$ , a contradiction), hence there exists  $f \in B' \setminus (\overline{B \setminus e})$ . We will show that  $(B \setminus e) \cup f$  is a basis of  $X$ . By Lemma 0.3.7 (iv) is  $(B \setminus e) \cup f$  independent, so it remains to show that  $(B \setminus e) \cup f$  spans  $X$ . For this it is sufficient to show that  $e \in X' := \overline{(B \setminus e) \cup f}$  because then  $B \subseteq X'$  and  $(B \setminus e) \cup f \subseteq X$  imply  $X = \overline{B} \subseteq X' \subseteq X$ , i.e.,  $X' = X$ . Assume  $e \notin X'$ . Apply the flat exchange axiom (M3) to  $X', Y := \overline{B \setminus e}$ ,  $e \in E \setminus (X' \cup Y)$ , and  $f \in X' \setminus Y$ : There exists  $Z \in \mathcal{A}$  such that  $e \in Z$ ,  $f \notin Z$ , and  $X' \cap Y = \overline{B \setminus e} \subseteq Z$ . But then  $B \subseteq Z$ , which leads to the contradiction  $X = \overline{B} \subseteq Z \not\ni f$ . ■

**0.3.9 Theorem (Basis Cardinality)** *Let  $M = (E, \mathcal{A})$  be a matroid and  $X \in \mathcal{A}$ . All bases of  $X$  have the same cardinality.*

**Proof** Let  $M = (E, \mathcal{A})$  be a matroid and  $X \in \mathcal{A}$ . For any bases  $B, B'$  of  $X$  set  $d(B, B') := |B \setminus B'| + |B' \setminus B|$ . Let  $B, B'$  be bases of  $X$ . If  $d(B, B') = 0$  then  $B = B'$ , so  $|B| = |B'|$ . If  $d(B, B') > 0$  then  $B \neq B'$ , and (after possibly interchanging  $B$  and  $B'$ ) there exists  $e \in B \setminus B'$ . By the basis exchange property is  $\tilde{B} := (B \setminus e) \cup f$  a basis of  $X$  for some  $f \in B' \setminus B$ , and by construction  $|B| = |\tilde{B}|$  and  $d(\tilde{B}, B') = d(B, B') - 2$ . Replacing  $B$  by  $\tilde{B}$  and repeating the above arguments (at most  $|B|$  times), we find a sequence of bases of  $X$  all of which have cardinality  $|B|$  where the last basis is equal to  $B'$ , which proves  $|B| = |B'|$ . ■

**0.3.10 Definition (Rank in Matroids)** Let  $M = (E, \mathcal{A})$  be a matroid and  $X \in \mathcal{A}$ . The uniquely determined cardinality of a basis of  $X$  is called the *rank of  $X$  in  $M$* , written as  $\text{rank}_M(X)$ . We call  $\text{rank}(M) := \text{rank}_M(E)$  the *rank of  $M$* . In addition we define for  $S \subseteq E$  the *rank of  $S$  in  $M$*  by  $\text{rank}_M(S) := \text{rank}_M(\overline{S})$ .

Note that by definition  $\text{rank}_M(\emptyset) = 0$ .

**0.3.11 Corollary** *Let  $M = (E, \mathcal{A})$  be a matroid and  $S \subseteq T \subseteq E$ . The length  $\ell$  of a maximal chain  $\overline{S} =: X^0 \subseteq X^1 \subseteq \dots \subseteq X^\ell =: \overline{T}$  with pairwise different sets  $X^0, X^1, \dots, X^\ell \in \mathcal{A}$  is  $\ell = \text{rank}_M(T) - \text{rank}_M(S)$ .*

**Proof** The claim is trivially true if  $\overline{S} = \overline{T}$ , so assume  $\overline{S} \neq \overline{T}$ . Consider  $X^{i-1}, X^i \in \mathcal{A}$  with  $X^{i-1} \subsetneq X^i$ . It is sufficient to show that  $\text{rank}_M(X^i) - \text{rank}_M(X^{i-1}) > 1$  if and only if

there exists  $Z \in \mathcal{A}$  such that  $X^{i-1} \subsetneq Z \subsetneq X^i$ . Let  $B$  be a basis of  $X^{i-1}$ , and choose any  $e \in X^i \setminus X^{i-1}$ , then by Lemma 0.3.7 (iv)  $B \cup e$  is an independent set. Then  $\overline{B \cup e} \subsetneq X^i$  if and only if  $\text{rank}_M(X^i) - \text{rank}_M(X^{i-1}) > 1$ , and then  $X^{i-1} \subsetneq Z := \overline{B \cup e} \subsetneq X^i$ . On the other hand, if there exists  $Z \in \mathcal{A}$  such that  $X^{i-1} \subsetneq Z \subsetneq X^i$  then by Lemma 0.3.7 (vi)  $B$  can be extended to a basis  $B'$  of  $Z$ , which also can be extended to a basis  $B''$  of  $X^i$ , hence  $\text{rank}_M(X^i) - \text{rank}_M(X^{i-1}) > 1$ . ■

The largest non-trivial flats, i.e., flats which are maximal in  $\mathcal{A} \setminus \{E\}$ , are those of rank  $r - 1$ , where  $r := \text{rank}(M)$ . For matroids defined by matrices of full rank, these flats correspond to subspaces of  $\mathbb{R}^d$  which have dimension  $d - 1$ ; this motivates to call these flats *hyperplanes*. The name of *colines* is used for the flats of rank  $r - 2$ :

**0.3.12 Definition (Hyperplanes, Colines)** Let  $M = (E, \mathcal{A})$  be a matroid, furthermore set  $r := \text{rank}(M)$ . The flats of rank  $r - 1$  are called *the hyperplanes of  $M$* , the flats of rank  $r - 2$  *the colines of  $M$* . The set of hyperplanes of a matroid is denoted by  $\mathcal{H}$ .

We introduce in the following another axiomatic system for matroids based on hyperplanes. These hyperplane axioms will be needed in the proof of Theorem 5.2.4.

**0.3.13 Definition (Hyperplane Axioms)** Let  $E$  be a finite set and  $\mathcal{H} \subseteq 2^E$  a set of subsets of  $E$ . We call  $\mathcal{H}$  *a set of hyperplanes* if and only if the following *hyperplane axioms* (H1) and (H2) are valid:

(H1) If  $X, Y \in \mathcal{H}$  such that  $X \subseteq Y$  then  $X = Y$ . (support)

(H2) For all  $X, Y \in \mathcal{H}$  with  $X \neq Y$  and  $e \in E \setminus (X \cup Y)$   
there exists  $Z \in \mathcal{H}$  such that  
 $e \in Z$  and  $X \cap Y \subseteq Z$ . (hyperplane exchange)

**0.3.14 Proposition** *A set  $\mathcal{H} \subseteq 2^E$  satisfies the hyperplane axioms (H1) and (H2) if and only if it is the set of hyperplanes of a matroid.*

**Proof** We first show that the hyperplane exchange axiom (H2) can be replaced by the following stronger version:

(H2<sup>s</sup>) For all  $X, Y \in \mathcal{H}$ ,  $e \in E \setminus (X \cup Y)$  and  $f \in X \setminus Y$   
there exists  $Z \in \mathcal{H}$  such that  
 $e \in Z$ ,  $f \notin Z$ , and  $X \cap Y \subseteq Z$ . (strong hyperplane exchange)

For this assume that there exist  $X, Y \in \mathcal{H}$ ,  $e \in E \setminus (X \cup Y)$ , and  $f \in X \setminus Y$  such that there is no  $Z \in \mathcal{H}$  with  $e \in Z$ ,  $f \notin Z$ , and  $X \cap Y \subseteq Z$ ; choose  $X$  and  $Y$  such that  $|X \cap Y|$  is maximal. By (H2) there exists  $X' \in \mathcal{H}$  such that  $e \in X'$  and  $X \cap Y \subseteq X'$ , but according to the above assumption  $f \notin X'$ . If  $Y \setminus X \subseteq X'$  then  $Y \subseteq X'$  and by (H1)  $Y = X'$ , in contradiction to  $f \in X' \setminus Y$ , so there exists  $g \in Y \setminus (X \cup X')$ . Furthermore  $e \in X' \setminus X$ , and as  $f \in X \cap X'$  implies  $X \cap Y \subsetneq X \cap X'$ ; by the maximality of  $|X \cap Y|$  there exists  $Y' \in \mathcal{H}$  such that  $g \in Y'$ ,  $e \notin Y'$ , and  $X \cap X' \subseteq Y'$ . Now  $e \in E \setminus (Y \cup Y')$ ,  $f \in X \cap X'$

implies  $f \in Y' \setminus Y$ , and by  $g \notin X \cap Y \subsetneq Y \cap Y' \ni g$  and the maximality argument there exists  $Z' \in \mathcal{H}$  such that  $e \in Z'$ ,  $f \notin Z'$ , and  $X \cap Y \subseteq Y \cap Y' \subseteq Z'$ , a contradiction. This proves that the strong hyperplane exchange (H2<sup>s</sup>) is satisfied by any set of hyperplanes. Let  $\mathcal{H} \subseteq 2^E$  be a set satisfying (H1) and (H2), hence also (H2<sup>s</sup>). We set

$$\mathcal{A} := \{X^1 \cap \dots \cap X^\ell \mid \ell \geq 1, X^i \in \mathcal{H} \text{ for all } i \in \{1, \dots, \ell\}\} \cup \{E\}$$

and show that  $(E, \mathcal{A})$  is a matroid, then obviously with  $\mathcal{H}$  as its set of hyperplanes. (M1) and (M2) are satisfied by definition. Let be  $X, Y \in \mathcal{A}$ ,  $e \in E \setminus (X \cup Y)$  and  $f \in X \setminus Y$ . Clearly  $X \neq E$  and  $Y \neq E$ . By definition there exist  $X^i, Y^j \in \mathcal{H}$  such that  $X \subseteq X^i \not\ni e$  and  $Y \subseteq Y^j \not\ni f$ . If  $e \in Y^j$  then  $Z := Y^j$  is sufficient for (M3), otherwise by  $f \in X^i \setminus Y^j$  and (H2<sup>s</sup>) there exists  $Z \in \mathcal{H}$  such that  $e \in Z$ ,  $f \notin Z$ , and  $X \cap Y \subseteq X^i \cap Y^j \subseteq Z$ , which proves (M3).

It is not difficult to see that the hyperplane axioms are satisfied by the set of hyperplanes  $\mathcal{H}$  of a matroid  $M$ , as  $\mathcal{H}$  is the set of maximal sets in  $M$  different from  $E$ . ■

We conclude this section by introducing an important notion which characterizes a special class of oriented matroids which corresponds to non-degeneracy in geometry:

**0.3.15 Definition (Uniform Matroid, Uniform Oriented Matroid)** A matroid  $M$  is called *uniform* if the set of hyperplanes of  $M$  is the set of all  $(\text{rank}(M) - 1)$ -subsets of  $E$ . An oriented matroid is called *uniform* if its underlying matroid is uniform.

Note that in a uniform matroid  $M$  a set  $H \subseteq E$  is a hyperplane of  $M$  if and only if  $|H| = \text{rank}(M) - 1$ . This is much stronger than the property in general matroids which says that every hyperplane contains at least  $\text{rank}(M) - 1$  elements. Uniform matroids of rank  $r$  can also be characterized as matroids with  $|E| \geq r$  and some subset  $S \subseteq E$  is independent if and only if  $|S| \leq r$ ; equivalently, a matroid of rank  $r$  is uniform if the set  $\mathcal{B}$  of bases is the set of all  $r$ -subsets of  $E$ . Note that in the original paper of Bland and Las Vergnas [BLV78] uniform matroids have been called *free*, and in Folkman and Lawrence [FL78] uniform oriented matroids have been called *simple* oriented matroids; we will use the notion *simple* differently (see Definition 1.1.3).

## 0.4 Minors

This section introduces minors of matroids and oriented matroids and the fundamental operations of *deletion* and *contraction* by which minors are constructed. In the case of a matroid defined by a matrix  $A$  as introduced in Section 0.1 these operations have intuitive geometric explanations. A deletion minor is obtained by simply deleting some of the column vectors of the matrix. In a sphere arrangement the deletion operation corresponds to the deletion of spheres. The contraction operation is less trivial as it includes a projection to the orthogonal space of the column vectors which are deleted. In a sphere arrangement the contraction minor is the (lower dimensional) sphere arrangement in the intersection of the spheres chosen to contract on. Later (in Chapters 4 and 5) we will discuss the question



of how oriented matroids can be extended. Sloppily speaking this is an operation in the opposite direction of constructing minors, and not surprisingly the study of minors is of great importance for the extension problem. The constructions of matroids such as minors and extensions are presented in more detail by Brylawski in Chapter 7 of [Whi86].

The formal definitions of deletion and contraction are as follows:

**0.4.1 Definition (Deletion and Contraction Minors)** Let  $M = (E, \mathcal{A})$  be a matroid and  $R \subseteq E$ . We define the *deletion minor of  $M$  w.r.t.  $R$*  to be the pair

$$M \setminus R := (E \setminus R, \mathcal{A} \setminus R), \text{ where } \mathcal{A} \setminus R := \{X \setminus R \mid X \in \mathcal{A}\},$$

and the *contraction minor of  $M$  w.r.t.  $R$*  to be the pair

$$M/R := (E \setminus R, \mathcal{A}/R), \text{ where } \mathcal{A}/R := \{X \setminus R \mid X \in \mathcal{A} \text{ and } R \subseteq X\}.$$

Let  $\mathcal{M} = (E, \mathcal{F})$  be an oriented matroid and  $R \subseteq E$ . We define the *deletion minor of  $\mathcal{M}$  w.r.t.  $R$*  to be the pair

$$\mathcal{M} \setminus R := (E \setminus R, \mathcal{F} \setminus R), \text{ where } \mathcal{F} \setminus R := \{X \setminus R \mid X \in \mathcal{F}\},$$

and the *contraction minor of  $\mathcal{M}$  w.r.t.  $R$*  to be the pair

$$\mathcal{M}/R := (E \setminus R, \mathcal{F}/R), \text{ where } \mathcal{F}/R := \{X \setminus R \mid X \in \mathcal{F} \text{ and } R \subseteq X^0\}.$$

Note that by definition the operations of deletion and contraction commute, i.e., for any matroid  $M = (E, \mathcal{A})$  and disjoint sets  $R, S \subseteq E$  holds:  $(M \setminus R)/S = (M/S) \setminus R$ ; analogously, the same is true for oriented matroids  $\mathcal{M}$ . Usually we will omit parentheses and write  $M \setminus R/S$  for  $(M \setminus R)/S$  etc.

It is straightforward to prove the following

**0.4.2 Proposition** *Deletion minors and contraction minors of matroids (oriented matroids) are matroids (oriented matroids, respectively). The underlying matroid of an oriented matroid minor is the corresponding minor of the underlying matroid:*

$$\underline{\mathcal{M} \setminus R} = \underline{\mathcal{M}} \setminus R \text{ and } \underline{\mathcal{M}/R} = \underline{\mathcal{M}}/R.$$

The rest of this section considers the rank of deletion and contraction minors and of flats (or covectors) in minors. These consideration concerning rank are very important in many inductive proofs.

Again it is helpful to remember sphere arrangements for an illustration. Let  $\mathcal{S}$  be a sphere arrangement in  $\mathbb{R}^d$  and  $S, R \subseteq E$  sets of indices of some of the spheres in  $\mathcal{S}$ . The statement of the following lemma then translates as follows: If the spheres in  $R$  are deleted, the rank spanned by the spheres in  $S \setminus R$  remains the same. However, if we contract to the spheres in  $R$ , the rank spanned by the projection of the spheres in  $S \setminus R$  is determined by the difference of ranks corresponding to  $S \cup R$  and  $R$ .

**0.4.3 Lemma** *Let  $M = (E, \mathcal{A})$  be a matroid,  $R, S \subseteq E$ . Then:*

- (i)  $\text{rank}_{M \setminus R}(S \setminus R) = \text{rank}_M(S \setminus R)$ .
- (ii)  $\text{rank}_{M/R}(S \setminus R) = \text{rank}_M(S \cup R) - \text{rank}_M(R)$ .

**Proof** (i) Let  $B \subseteq S \setminus R$  be a basis of  $\text{span}_M(S \setminus R)$  in  $M$  (cf. Lemma 0.3.7 (vi)). We show that  $B$  is a basis of  $\text{span}_{M \setminus R}(S \setminus R)$  in  $M \setminus R$ .  $B$  is independent in  $M$ , hence (by Lemma 0.3.7 (ii)) for all  $e \in B$  there exists  $Z \in \mathcal{A}$  such that  $B \setminus e \subseteq Z \not\ni e$  and also  $B \setminus e \subseteq Z \setminus R \not\ni e$  since  $B \subseteq E \setminus R$ . This is equivalent to: for all  $e \in B$  there exists  $Z' \in \mathcal{A} \setminus R$  such that  $B \setminus e \subseteq Z' \not\ni e$ , so  $B$  is independent in  $M \setminus R$ . On the other hand  $\text{span}_M(B) = \text{span}_M(S \setminus R)$  implies that for all  $Z \in \mathcal{A}$  with  $B \subseteq Z$  also  $S \setminus R \subseteq Z$ , hence for all  $Z' \in \mathcal{A} \setminus R$  with  $B \subseteq Z'$  also  $S \setminus R \subseteq Z'$ , therefore  $\text{span}_{M \setminus R}(B) = \text{span}_{M \setminus R}(S \setminus R)$ .

- (ii) Let  $B' \subseteq R$  be a basis of  $\text{span}_M(R)$  and  $B \subseteq S \cup R$  a basis of  $\text{span}_M(S \cup R)$  in  $M$  such that  $B' \subseteq B$  (cf. Lemma 0.3.7 (vi)); remark that  $B \setminus B' \subseteq E \setminus \overline{B'} = E \setminus R$ . We show that  $B \setminus B'$  is a basis of  $\text{span}_{M/R}(S \setminus R)$  in  $M/R$ .  $B$  is independent in  $M$ , hence (by Lemma 0.3.7 (ii)) for all  $e \in B \setminus B'$  there exists  $Z \in \mathcal{A}$  such that  $B' \subseteq B \setminus e \subseteq Z \not\ni e$  and also  $(B \setminus (B' \cup e)) \cup R \subseteq Z \not\ni e$  since  $B' \subseteq Z$  implies  $R \subseteq Z$ . This is equivalent to: for all  $e \in B \setminus B'$  there exists  $Z' \in \mathcal{A}/R$  such that  $(B \setminus B') \setminus e \subseteq Z' \not\ni e$ , so  $B \setminus B'$  is independent in  $M/R$ . On the other hand  $\text{span}_M(B) = \text{span}_M(S \cup R)$  implies that for all  $Z \in \mathcal{A}$  with  $R \subseteq Z$  and  $B \subseteq Z$  also  $S \cup R \subseteq Z$ , hence for all  $Z \in \mathcal{A}$  with  $R \subseteq Z$  and  $B \setminus B' \subseteq Z$  also  $S \cup R \subseteq Z$ , by this for all  $Z' \in \mathcal{A}/R$  with  $B \setminus B' \subseteq Z'$  also  $S \setminus R \subseteq Z'$  and therefore  $\text{span}_{M/R}(B \setminus B') = \text{span}_{M/R}(S \setminus R)$ . ■

Now it is straightforward to determine the rank of the minors:

**0.4.4 Corollary** *Let  $M = (E, \mathcal{A})$  be a matroid,  $R \subseteq E$ . Then:*

- (i)  $\text{rank}(M \setminus R) = \text{rank}_M(E \setminus R)$ .
- (ii)  $\text{rank}(M/R) = \text{rank}(M) - \text{rank}_M(R)$ .

In the illustrations of oriented matroids it is very natural to consider the *dimension* of subspaces spanned by vectors or of faces in sphere arrangements. For example, a region of highest dimension in a sphere arrangement in  $\mathbb{R}^d$  has dimension  $d - 1$ ; in the corresponding oriented matroid, this region is represented by a covector with maximal support, and the corresponding flat has rank 0 in the underlying matroid. It is convenient to define the rank of covectors and the dimension of oriented matroids as follows:

**0.4.5 Definition (Rank and Dimension in Oriented Matroids)** Let  $\mathcal{M} = (E, \mathcal{F})$  be an oriented matroid. The *rank of  $\mathcal{M}$* , written as  $\text{rank}(\mathcal{M})$ , is the rank of the underlying matroid. For a covector  $X \in \mathcal{F}$  we define  $\text{rank}_{\mathcal{M}}(X) := \text{rank}(\mathcal{M}) - \text{rank}_{\underline{\mathcal{M}}}(X^0)$  to be the *rank of  $X$  in  $\mathcal{M}$* . The *dimension* equals  $\text{rank} - 1$ , i.e.,  $\text{dim}(\mathcal{M}) := \text{rank}(\mathcal{M}) - 1$  and, for  $X \in \mathcal{F}$ ,  $\text{dim}_{\mathcal{M}}(X) := \text{rank}_{\mathcal{M}}(X) - 1$ .

By the above definition, the dimension of a covector equals the dimension of the corresponding face in a sphere arrangement (cf. Sections 0.1 and 0.7).

We extend the results concerning rank of matroid minors to oriented matroids:

**0.4.6 Corollary** *Let  $\mathcal{M} = (E, \mathcal{F})$  be an oriented matroid,  $R \subseteq E$ ,  $X \in \mathcal{F}$ . Then:*

- (i)  $\text{rank}(\mathcal{M} \setminus R) = \text{rank}_{\underline{\mathcal{M}}}(E \setminus R)$ .
- (ii)  $\text{rank}(\mathcal{M}/R) = \text{rank}(\mathcal{M}) - \text{rank}_{\underline{\mathcal{M}}}(R)$ .
- (iii)  $\text{rank}_{\mathcal{M} \setminus R}(X \setminus R) = \text{rank}(\mathcal{M} \setminus R) - \text{rank}_{\underline{\mathcal{M}}}(X^0 \setminus R)$ .
- (iv)  $\text{rank}_{\mathcal{M}/R}(X \setminus R) = \text{rank}_{\mathcal{M}}(X)$ , provided that  $R \subseteq X^0$ .

**Proof**

- (iii)  $\text{rank}_{\mathcal{M} \setminus R}(X \setminus R) = \text{rank}(\mathcal{M} \setminus R) - \text{rank}_{\underline{\mathcal{M} \setminus R}}((X \setminus R)^0)$   
 $= \text{rank}(\mathcal{M} \setminus R) - \text{rank}_{\underline{\mathcal{M} \setminus R}}(X^0 \setminus R) = \text{rank}(\mathcal{M} \setminus R) - \text{rank}_{\underline{\mathcal{M}}}(X^0 \setminus R)$ .
- (iv)  $\text{rank}_{\mathcal{M}/R}(X \setminus R) = \text{rank}(\mathcal{M}/R) - \text{rank}_{\underline{\mathcal{M}/R}}((X \setminus R)^0)$   
 $= \text{rank}(\mathcal{M}) - \text{rank}_{\underline{\mathcal{M}}}(R) - \text{rank}_{\underline{\mathcal{M}/R}}(X^0 \setminus R)$   
 $= \text{rank}(\mathcal{M}) - \text{rank}_{\underline{\mathcal{M}}}(R) - (\text{rank}_{\underline{\mathcal{M}}}(X^0 \cup R) - \text{rank}_{\underline{\mathcal{M}}}(R))$   
 $= \text{rank}(\mathcal{M}) - \text{rank}_{\underline{\mathcal{M}}}(X^0 \cup R) = \text{rank}(\mathcal{M}) - \text{rank}_{\underline{\mathcal{M}}}(X^0) = \text{rank}_{\mathcal{M}}(X). \quad \blacksquare$

Of special importance are minors w.r.t. a single element. We distinguish elements with special properties w.r.t. deletion and contraction, namely so-called *loops* and *coloops*. Loops are elements which “never affect”: they are contained in every flat. In the case of matroids defined by matrices the column vector corresponding to a loop is simply the zero vector. Hence, deleting a loop or contracting to a loop does not change anything. Coloops are elements which “always affect”: the rank of a collection of elements increases or decreases whenever a coloop is added or deleted, respectively. In the case of matroids defined by matrices the column vector corresponding to a coloop has the property that all other vectors are contained in a proper subspace not containing the coloop vector. In a sphere arrangement a coloop corresponds to a sphere such that all other spheres intersect in a common point which is not on the coloop sphere. Loops and coloops are related by duality (see Section 0.5).

**0.4.7 Definition (Loop and Coloop)** Let  $M = (E, \mathcal{A})$  be a matroid and  $e \in E$ . We call  $e$  a *loop* of  $M$  if  $e \in X$  for all  $X \in \mathcal{A}$ . We call  $e$  a *coloop* of  $M$  if  $E \setminus e \in \mathcal{A}$ . Let  $\mathcal{M} = (E, \mathcal{F})$  be an oriented matroid and  $e \in E$ . We call  $e$  a *loop (coloop)* of  $\mathcal{M}$  if  $e$  is a loop (coloop, respectively) of  $\underline{\mathcal{M}}$ . If  $M$  or  $\mathcal{M}$  is determined from the context we will not mention  $M$  or  $\mathcal{M}$  and simply say  $e$  is a *loop* or  $e$  is a *coloop*.

We will extend the notion of loops later to arbitrary sets of sign vectors.

The following results concerning single element deletion and contraction minors follow from the general case discussed above:

**0.4.8 Corollary** *Let  $M = (E, \mathcal{A})$  be a matroid,  $e \in E$ , and  $S \subseteq E$ . Then:*

- (i)  $\text{rank}(M \setminus e) = \text{rank}_M(E \setminus e) = \begin{cases} \text{rank}(M) & \text{if } e \text{ is not a coloop,} \\ \text{rank}(M) - 1 & \text{otherwise.} \end{cases}$
- (ii)  $\text{rank}(M/e) = \text{rank}(M) - \text{rank}_M(e) = \begin{cases} \text{rank}(M) & \text{if } e \text{ is a loop,} \\ \text{rank}(M) - 1 & \text{otherwise.} \end{cases}$
- (iii)  $\text{rank}_{M \setminus e}(S \setminus e) = \text{rank}_M(S \setminus e) = \begin{cases} \text{rank}_M(S) & \text{if } \text{span}_M(S \setminus e) = \text{span}_M(S), \\ \text{rank}_M(S) - 1 & \text{otherwise.} \end{cases}$
- (iv)  $\text{rank}_{M/e}(S \setminus e) = \text{rank}_M(S \cup e) - \text{rank}_M(e) = \begin{cases} \text{rank}_M(S) & \text{if } e \text{ is a loop,} \\ \text{rank}_M(S) - 1 & \text{otherwise,} \end{cases}$   
provided that  $e \in S$ .

**0.4.9 Corollary** *Let  $\mathcal{M} = (E, \mathcal{F})$  be an oriented matroid,  $e \in E$ ,  $X \in \mathcal{F}$ . Then:*

- (i)  $\text{rank}(\mathcal{M} \setminus e) = \text{rank}_{\underline{\mathcal{M}}}(E \setminus e) = \begin{cases} \text{rank}(\mathcal{M}) & \text{if } e \text{ is not a coloop,} \\ \text{rank}(\mathcal{M}) - 1 & \text{otherwise.} \end{cases}$
- (ii)  $\text{rank}(\mathcal{M}/e) = \text{rank}(\mathcal{M}) - \text{rank}_{\underline{\mathcal{M}}}(e) = \begin{cases} \text{rank}(\mathcal{M}) & \text{if } e \text{ is a loop,} \\ \text{rank}(\mathcal{M}) - 1 & \text{otherwise.} \end{cases}$
- (iii)  $\text{rank}_{\mathcal{M} \setminus e}(X \setminus e) = \begin{cases} \text{rank}_{\mathcal{M}}(X) + 1 & \text{if } e \text{ not a coloop and } \text{span}_{\underline{\mathcal{M}}}(X^0 \setminus e) \neq X^0, \\ \text{rank}_{\mathcal{M}}(X) - 1 & \text{if } e \text{ a coloop and } \text{span}_{\underline{\mathcal{M}}}(X^0 \setminus e) = X^0, \\ \text{rank}_{\mathcal{M}}(X) & \text{otherwise.} \end{cases}$
- (iv)  $\text{rank}_{\mathcal{M}/e}(X \setminus e) = \text{rank}_{\mathcal{M}}(X)$ , provided that  $X_e = 0$ .

**Proof** (iii)  $\text{rank}_{\mathcal{M} \setminus e}(X \setminus e) = \text{rank}(\mathcal{M} \setminus e) - \text{rank}_{\underline{\mathcal{M}}}(X^0 \setminus e)$ , where

$$\text{rank}(\mathcal{M} \setminus e) = \begin{cases} \text{rank}(\mathcal{M}) & \text{if } e \text{ is not a coloop,} \\ \text{rank}(\mathcal{M}) - 1 & \text{otherwise,} \end{cases}$$

$$\text{and } \text{rank}_{\underline{\mathcal{M}}}(X^0 \setminus e) = \begin{cases} \text{rank}_{\underline{\mathcal{M}}}(X^0) & \text{if } \text{span}_{\underline{\mathcal{M}}}(X^0 \setminus e) = X^0, \\ \text{rank}_{\underline{\mathcal{M}}}(X^0) - 1 & \text{otherwise,} \end{cases}$$

which implies the claim. ■

## 0.5 Duality

Duality is one of the outstanding notions in the theory of oriented matroids. However, in the present thesis duality does not play an important role; actually only few of the later results need duality. Nevertheless, for completeness we give in the following a short introduction to some basic notions and results of duality.

Before the definitions in terms of oriented matroids are given, consider (orthogonal) duality in real vector spaces. Two vectors  $x, y \in \mathbb{R}^d$  are orthogonal if their scalar product  $\sum_i x_i y_i$  equals to zero. An obvious property of orthogonal vectors  $x, y$  is that if  $x_i y_i > 0$

for some  $i$  then  $x_j y_j < 0$  for some  $j \neq i$ . This property characterizes orthogonal spaces for sign vectors:

**0.5.1 Definition (Orthogonal, Dual)** Let  $E$  be a non-empty finite set. Two sign vectors  $X, Y \in \{-, +, 0\}^E$  on  $E$  are called *orthogonal* (denoted by  $X * Y$ ) if either  $\underline{X} \cap \underline{Y} = \emptyset$  or there are  $e, f \in \underline{X} \cap \underline{Y}$  such that  $X_e = Y_e$  and  $X_f = -Y_f$ . The *orthogonal space* (or *dual space*) of a set  $\mathcal{F}$  of sign vectors on  $E$  is the set

$$\mathcal{F}^* := \{X \in \{-, +, 0\}^E \mid X * Y \text{ for all } Y \in \mathcal{F}\}.$$

As explained above, if two vectors  $x, y \in \mathbb{R}^d$  are orthogonal then also the corresponding sign vectors  $\text{sign}(x), \text{sign}(y)$ . Furthermore  $\text{sign}(V)^* = \text{sign}(V^\perp)$  for any linear subspace  $V$  and its orthogonal space  $V^\perp$ , where  $\text{sign}(V) := \{\text{sign}(x) \mid x \in V\}$  (this is not obvious, but we do not discuss a proof here).

For a sign vector  $X \in \{-, +, 0\}^E$  we write  $X \leq 0$  if  $X_e \in \{-, 0\}$  for all  $e \in E$ , and similarly  $X \geq 0$  if  $-X \leq 0$ . Furthermore, we write  $X < 0$  or  $X > 0$  if  $X \leq 0$  or  $X \geq 0$  and all signs are different from 0, respectively. The same notation is extended to single signs (e.g.,  $X_e > 0$  is equivalent to  $X_e = +$ ).

The following duality results are mainly due to Bland and Las Vergnas [BLV78]. The presentation follows basically Fukuda [Fuk00b].

**0.5.2 Lemma** Let  $(E, \mathcal{F})$  be an oriented matroid,  $R \subseteq E$ . Then  $(\mathcal{F} \setminus R)^* = \mathcal{F}^*/R$  and  $(\mathcal{F}/R)^* = \mathcal{F}^* \setminus R$ .

**Proof**  $(\mathcal{F} \setminus R)^* = \mathcal{F}^*/R$  and  $(\mathcal{F}/R)^* \supseteq \mathcal{F}^* \setminus R$  are satisfied by all  $\mathcal{F} \subseteq \{-, +, 0\}^E$ , which can be proved easily. For the proof of  $(\mathcal{F}/R)^* \subseteq \mathcal{F}^* \setminus R$  we will need (F1) and (F3). It is sufficient to discuss the case  $|R| = 1$  since then by induction for  $|R| > 1$  and any  $r \in R$  follows

$$(\mathcal{F}/R)^* = ((\mathcal{F}/(R \setminus r))/r)^* = (\mathcal{F}/(R \setminus r))^* \setminus r = (\mathcal{F}^* \setminus (R \setminus r)) \setminus r = \mathcal{F}^* \setminus R.$$

So assume  $R = \{r\}$  for some  $r \in E$ . Let be  $Y \in (\mathcal{F}/r)^*$ , we will show  $Y \in \mathcal{F}^* \setminus r$ . Set

$$\begin{aligned} \mathcal{F}^= &:= \{X \in \mathcal{F} \mid X_r = 0\}, \\ \mathcal{F}^> &:= \{X \in \mathcal{F} \mid X_{Y^+} \geq 0, X_{Y^-} \leq 0, X_r > 0\}, \\ \mathcal{F}^< &:= \{X \in \mathcal{F} \mid X_{Y^+} \geq 0, X_{Y^-} \leq 0, X_r < 0\}, \\ \mathcal{F}^\pm &:= \{X \in \mathcal{F} \mid \text{there exist } i, j \in \underline{Y} \setminus r \text{ such that } X_i = Y_i, X_j = -Y_j\}. \end{aligned}$$

Consider a sign vector  $Y' \in \{-, +, 0\}^E$  such that  $Y' \setminus r = Y$ ; we will show that  $Y' \in \mathcal{F}^*$  for an appropriate choice of  $Y'_r \in \{-, +, 0\}$ , which proves  $Y \in \mathcal{F}^* \setminus r$ . It is obvious that  $Y' \in (\mathcal{F}^=)^*$  and  $Y' \in (\mathcal{F}^\pm)^*$  independent from the choice of  $Y'_r$ . If  $X \in \mathcal{F} \setminus (\mathcal{F}^= \cup \mathcal{F}^\pm)$  then  $X \in \mathcal{F}^> \cup \mathcal{F}^<$  or  $-X \in \mathcal{F}^> \cup \mathcal{F}^<$ , and by (F1) it is sufficient to prove that  $X \in \mathcal{F}^> \cup \mathcal{F}^<$  implies  $X * Y'$  for an appropriate choice of  $Y'_r \in \{-, +, 0\}$  (which will be independent of  $X$ , of course). If  $\mathcal{F}^< = \emptyset$  then by (F1)  $X_{\underline{Y}} \neq \mathbf{0}$  for all  $X \in \mathcal{F}^>$  since otherwise  $-X \in \mathcal{F}^<$ , and it is sufficient to set  $Y'_r = -$ . If  $\mathcal{F}^> = \emptyset$  then similarly it is sufficient to set  $Y'_r = +$ . Assume for the rest of the proof that  $\mathcal{F}^> \neq \emptyset$  and  $\mathcal{F}^< \neq \emptyset$ .

Consider  $X \in \mathcal{F}^>$  and  $X' \in \mathcal{F}^<$ . By (F3) there exists  $Z' \in \mathcal{F}$  such that  $Z'_r = 0$  and  $Z'_i = (X \circ X')_i$  for all  $i \in E \setminus D(X, X')$ . Obviously  $\underline{Y} \subseteq E \setminus D(X, X')$  and hence  $Z'_{Y^+} \geq 0$  and  $Z'_{Y^-} \leq 0$ . Furthermore  $Z := Z' \setminus r \in \mathcal{F}/r$  implies  $Z * Y$ , and hence  $X_{\underline{Y}} = X'_{\underline{Y}} = \mathbf{0}$ . This is true for all  $X \in \mathcal{F}^>$  and  $X' \in \mathcal{F}^<$ , i.e.,  $\mathcal{F}^> = \{X \in \mathcal{F} \mid X_{\underline{Y}} = \mathbf{0}, X_r > 0\}$  and  $\mathcal{F}^< = \{X \in \mathcal{F} \mid X_{\underline{Y}} = \mathbf{0}, X_r < 0\}$ , hence it is sufficient to set  $Y'_r = 0$ . ■

The following result can be viewed as a generalization of the Farkas' Lemma (e.g., see Section 7.3 in [Sch86]) to oriented matroids. We formulate it here as a 3-painting property:

**0.5.3 Proposition (3-Painting [BLV78, BLV79])** *Let  $(E, \mathcal{F})$  be an oriented matroid, and let  $R \cup G \cup W = E$  be a partition of  $E$  (i.e.,  $R \cap G = \emptyset$  etc.) and  $r \in R$ . One might think of the partition as a coloring of the elements:  $R$ ,  $G$ , and  $W$  then stand for red, green, and white, respectively. Then exactly one of (i) and (ii) holds, where*

- (i) *there exists  $X \in \mathcal{F}$  such that  $X_r > 0, X_R \geq 0, X_G \leq 0$ ;*
- (ii) *there exists  $Y \in \mathcal{F}^*$  such that  $Y_r > 0, Y_R \geq 0, Y_G \leq 0, Y_W = 0$ .*

**Proof** It is clear by the definition of orthogonality that (i) and (ii) can not be satisfied at the same time. Assume that (i) is not satisfied, we prove (ii), first for  $G = \emptyset$ . We will need for the proof only axioms (F1) and (F2).

If for all  $X \in \mathcal{F}$  there exist  $i, j \in R$  such that  $X_i = +$  and  $X_j = -$  then define  $Y$  by  $Y_e = +$  if  $e \in R$  and  $Y_e = 0$  otherwise. Then  $Y$  proves that (ii) is valid. Otherwise (F1) implies that  $\mathcal{R} := \{X \in \mathcal{F} \mid X_R \geq 0\} \neq \emptyset$ . Choose any  $X' \in \mathcal{R}$  such that  $\underline{X'_R}$  is maximal; by (F2) this means that  $\underline{X_R} \subseteq \underline{X'_R}$  for all  $X \in \mathcal{R}$ . As (i) is not satisfied and by assumption  $G = \emptyset, X'_r = 0$ . Define  $Y$  by  $Y_e = +$  if  $e \in R \setminus \underline{X'_R}$  and  $Y_e = 0$  otherwise. Obviously  $Y_r > 0, Y_R \geq 0$ , and  $Y_W = 0$ ; it remains to prove that  $Y \in \mathcal{F}^*$ . Let be  $X \in \mathcal{F}$ . If  $X \in \mathcal{R}$  then  $\underline{X} \cap \underline{Y} = \emptyset$ , hence  $X * Y$ . If  $X \notin \mathcal{R}$  and  $\underline{X} \cap \underline{Y} \neq \emptyset$ , then there exist  $i, j \in R \setminus \underline{X'_R}$  with  $X_i = +$  and  $X_j = -$  (if no such  $i, j$  exist then by (F2)  $X' \circ X$  or  $X' \circ (-X)$  belongs to  $\mathcal{R}$ , contradicting the maximality of  $\underline{X'_R}$ ); this proves  $X * Y$ .

Observe that for all  $S \subseteq E$  the set  $\overline{S}\mathcal{F} := \{\overline{S}X \mid X \in \mathcal{F}\}$  also satisfies (F1) and (F2), furthermore  $(\overline{S}\mathcal{F})^* = \overline{S}(\mathcal{F})^*$ . The proof for general  $G$  follows then from the proof for  $(E, \tilde{\mathcal{F}})$  where  $\tilde{\mathcal{F}} := \overline{G}\mathcal{F}, \tilde{r} = r, \tilde{R} = R \cup G, \tilde{W} = W$ , and  $\tilde{G} = \emptyset$ . ■

A stronger formulation of the 3-painting property is the following well-known variation:

**0.5.4 Proposition (4-Painting [BLV78, BLV79])** *Let  $(E, \mathcal{F})$  be a an oriented matroid, and let  $R \cup G \cup B \cup W = E$  be a partition of  $E$  (the additional set  $B$  might be thought of as the set of elements colored in black) and  $r \in R$ . Then exactly one of (i) and (ii) holds, where*

- (i) *there exists  $X \in \mathcal{F}$  such that  $X_r > 0, X_R \geq 0, X_G \leq 0, X_B = 0$ ;*
- (ii) *there exists  $Y \in \mathcal{F}^*$  such that  $Y_r > 0, Y_R \geq 0, Y_G \leq 0, Y_W = 0$ .*

**Proof** It is obvious that not (i) and (ii) are satisfied at the same time. Assume that (i) does not hold, then there is no  $X' \in \mathcal{F}/B$  such that  $X'_r > 0$ ,  $X'_R \geq 0$ , and  $X'_G \leq 0$ . By Farkas' Lemma (i.e., Proposition 0.5.3) applied to the oriented matroid  $\mathcal{M}/B$  there exists  $Y' \in (\mathcal{F}/B)^*$  such that  $Y'_r > 0$ ,  $Y'_R \geq 0$ ,  $Y'_G \leq 0$ ,  $Y'_W = 0$ , and by Lemma 0.5.2  $(\mathcal{F}/B)^* = \mathcal{F}^* \setminus B$ , hence there exists  $Y \in \mathcal{F}^*$  such that  $Y' = Y \setminus B$ , which shows that (ii) is satisfied. ■

**0.5.5 Lemma** *Let be  $\mathcal{F} \subseteq \{-, +, 0\}$ ,  $Y \in \mathcal{F}^*$  and  $e \in \underline{Y}$  such that  $\bar{e}Y \in \mathcal{F}^*$ . Then also  $Y' \in \mathcal{F}^*$  where  $Y' \setminus e = Y \setminus e$  and  $Y'_e = 0$ .*

**Proof** Let be  $\mathcal{F} \subseteq \{-, +, 0\}^E$ ,  $Y \in \mathcal{F}^*$  and  $e \in \underline{Y}$  such that  $\bar{e}Y \in \mathcal{F}^*$ . Define  $Y'$  by  $Y' \setminus e = Y \setminus e$  and  $Y'_e = 0$ . Let be  $X \in \mathcal{F}$ . By definition of  $Y$ ,  $\bar{e}Y \in \mathcal{F}^*$ , either  $\underline{X} \cap \underline{Y} = \emptyset$ , in which case  $\underline{X} \cap \underline{Y}' = \emptyset$  and hence  $X * Y'$ , or there exist  $g, h, i, j \in \underline{X} \cap \underline{Y}$  such that  $X_g = Y_g$  and  $X_h = -Y_h$  and  $X_i = \bar{e}Y_i$  and  $X_j = -(\bar{e}Y)_j$ . Because of  $e \in D(Y, \bar{e}Y)$  it is not possible that  $g = i = e$  or  $h = j = e$ , hence there are  $i' \in \{g, i\} \setminus e$  and  $j' \in \{h, j\} \setminus e$  such that  $X_{i'} = Y_{i'}$  and  $X_{j'} = -Y_{j'}$ , which proves  $X * Y'$ . This holds for every  $X \in \mathcal{F}$ , which proves  $Y' \in \mathcal{F}^*$ . ■

**0.5.6 Theorem (Dual Oriented Matroid [BLV78])** *Let  $(E, \mathcal{F})$  be an oriented matroid. Then  $(E, \mathcal{F}^*)$  is also an oriented matroid.*

**Proof** Let  $(E, \mathcal{F})$  be an oriented matroid and consider the dual space  $\mathcal{F}^*$ . Obviously  $\mathbf{0} \in \mathcal{F}^*$ , furthermore the symmetry in the definition of orthogonality implies that (F1) holds for  $\mathcal{F}^*$ .

For (F2) consider  $Y, Y' \in \mathcal{F}^*$ , then  $X * Y$  implies  $\underline{X} \cap \underline{Y} = \emptyset$  or that there exist elements  $e, f \in \underline{X} \cap \underline{Y} \subseteq \underline{X} \cap (\underline{Y} \circ \underline{Y}')$  such that  $X_e = Y_e$  and  $X_f = -Y_f$ ; In the latter case follows  $X * (Y \circ Y')$  from  $Y_e = (Y \circ Y')_e$  and  $Y_f = (Y \circ Y')_f$ . In the first case, i.e.,  $\underline{X} \cap \underline{Y} = \emptyset$ , we similarly consider the implications of  $X * Y'$ : either  $\underline{X} \cap \underline{Y}' = \emptyset$  which implies  $\underline{X} \cap (\underline{Y} \circ \underline{Y}') = \emptyset$ , or there exist  $e, f \in \underline{X} \cap \underline{Y}' \subseteq \underline{X} \cap (\underline{Y} \circ \underline{Y}')$  such that  $X_e = Y'_e = (Y \circ Y')_e$  and  $X_f = -Y'_f = -(Y \circ Y')_f$ , which in both cases proves that  $X * (Y \circ Y')$ .

It remains to show that (F3) is satisfied by  $\mathcal{F}^*$ . Let be  $Y, Y' \in \mathcal{F}^*$  and  $e \in D := D(Y, Y')$ . We have to show that there exists  $Z \in \mathcal{F}^*$  such that  $Z_e = 0$  and  $Z_f = (Y \circ Y')_f$  for all  $f \in E \setminus D$ ; when we define  $S := D \setminus e$  and  $\tilde{Y} := Y \circ Y'$ , this is equivalent to  $\tilde{Y} \setminus D \in \mathcal{F}^*/e \setminus S = (\mathcal{F} \setminus e/S)^*$  (the last equality follows by Lemma 0.5.2). Let be  $X \in \mathcal{F}$  such that  $X \setminus D \in \mathcal{F} \setminus e/S$ , i.e.,  $X_S = \mathbf{0}$ . We have to show that  $(X \setminus D) * (\tilde{Y} \setminus D)$ . Obviously  $X * Y$  and  $X * Y'$  imply  $X * \tilde{Y}$ , and because of  $X_S = \mathbf{0}$  also  $(X \setminus S) * (\tilde{Y} \setminus S)$ , and similarly  $(X \setminus S) * ((Y' \circ Y) \setminus S)$ . Since  $\tilde{Y} \setminus D = (Y' \circ Y) \setminus D$ , Lemma 0.5.5 implies that  $(X \setminus D) * (\tilde{Y} \setminus D)$ . ■

**0.5.7 Definition (Dual Oriented Matroid)** Let  $\mathcal{M} = (E, \mathcal{F})$  be an oriented matroid. Then we call the oriented matroid  $\mathcal{M}^* := (E, \mathcal{F}^*)$  the dual of  $\mathcal{M}$ .

**0.5.8 Proposition (Dual of Dual [BLV78])**  $\mathcal{M}^{**} = \mathcal{M}$  for every oriented matroid  $\mathcal{M}$ .

**Proof** Let  $\mathcal{M} = (E, \mathcal{F})$  be an oriented matroid. The proof for  $\mathcal{F} \subseteq \mathcal{F}^{**}$  is trivial. We show  $\mathcal{F}^{**} \subseteq \mathcal{F}$  by induction on  $n = |E|$ . If  $n = 0$  then  $\mathcal{F} = \mathcal{F}^* = \{\mathbf{0}\}$ , where  $\mathbf{0}$  is the

zero vector with empty ground set. If  $n = 1$  then  $\mathcal{F} = \{(0)\}$  and  $\mathcal{F}^* = \{(-), (+), (0)\}$  or vice versa. Therefore  $\mathcal{F} = \mathcal{F}^{**}$  for  $n \leq 1$ . Assume  $n \geq 2$ . Let be  $X \in \mathcal{F}^{**}$ ; show  $X \in \mathcal{F}$ . If  $X^0 \neq \emptyset$  choose  $e \in X^0$ , then by Lemma 0.5.2 and induction

$$X \setminus e \in \mathcal{F}^{**}/e = (\mathcal{F}^* \setminus e)^* = (\mathcal{F}/e)^{**} = \mathcal{F}/e.$$

Then  $X \in \mathcal{F}$ . Otherwise  $X^0 = \emptyset$ . For every  $e \in E$  holds, similarly as above,

$$X \setminus e \in \mathcal{F}^{**} \setminus e = (\mathcal{F}^*/e)^* = (\mathcal{F} \setminus e)^{**} = \mathcal{F} \setminus e.$$

Let be  $X' \in \mathcal{F}$  such that  $X' \setminus e = X \setminus e$ . If  $X'_e = X_e$  then  $X' = X \in \mathcal{F}$ . If  $X'_e = 0$  then let for  $f \in E \setminus e$  be  $X'' \in \mathcal{F}$  such that  $X'' \setminus f = X \setminus f$ . Then  $X' \circ X'' = X \in \mathcal{F}$ . Finally, if  $X'_e = -X_e$ , the sign vectors  $X, X' \in \mathcal{F}^{**}$  only differ in  $e \in D(X, X')$ , which implies by Lemma 0.5.5 that  $X''$  defined by  $X'' \setminus e = X \setminus e$  and  $X''_e = 0$  also is in  $\mathcal{F}^{**}$ . Then  $X'' \in \mathcal{F}$  (see above), hence  $X'' \circ (-X') = X \in \mathcal{F}$ . ■

In Definition 0.4.7 we have defined loops and coloops. The name of a coloop is motivated by the following fact, where the prefix “co-” stands for “dual”:

**0.5.9 Lemma** *Let  $\mathcal{M} = (E, \mathcal{F})$  be an oriented matroid and  $e \in E$ . Then  $e$  is a loop of  $\mathcal{M}$  if and only if  $e$  is a coloop of the dual  $\mathcal{M}^*$ .*

**Proof**  $e$  is a loop of  $\mathcal{M}$  if and only if  $X_e = 0$  for all  $X \in \mathcal{F}$ . By definition of the dual space, there is  $Y \in \mathcal{F}^*$  where  $Y \setminus e = \mathbf{0}$  and  $Y_e \neq 0$ . Hence  $e$  is a coloop of  $\mathcal{M}^*$ . The reverse direction is also very simple. ■

The previous results lead to the following:

**0.5.10 Corollary** *Let  $\mathcal{M} = (E, \mathcal{F})$  be an oriented matroid. Then the rank of the dual is determined by  $\text{rank}(\mathcal{M}^*) = |E| - \text{rank}(\mathcal{M})$ .*

**Proof** The proof is by induction on  $n := |E|$ . If  $n = 0$  then  $\text{rank}(\mathcal{M}) = 0 = \text{rank}(\mathcal{M}^*)$ . If  $n > 0$  let  $e \in E$ . We assume by induction that  $\text{rank}((\mathcal{M} \setminus e)^*) = |E \setminus e| - \text{rank}(\mathcal{M} \setminus e)$ ; by Lemma 0.5.2 this is equivalent to  $\text{rank}(\mathcal{M} \setminus e) + \text{rank}(\mathcal{M}^*/e) = |E| - 1$ . We consider the two cases that  $e$  is a coloop of  $\mathcal{M}$  or not; in either case, the combination of Lemma 0.5.9 and Corollary 0.4.9 (i) and (ii) leads to  $\text{rank}(\mathcal{M}) + \text{rank}(\mathcal{M}^*) - 1 = |E| - 1$ , which implies the claim. ■

Our approach for proving the result of Corollary 0.5.10 is rather unusual, normally it is a corollary of the following fact:

**0.5.11 Proposition** *Let  $\mathcal{M} = (E, \mathcal{F})$  be an oriented matroid. A set  $B \subseteq E$  is a basis of  $\mathcal{M}$  if and only if  $E \setminus B$  is a basis of  $\mathcal{M}^*$ .*

**Proof** Set  $n := |E|$  and  $r := \text{rank}(\mathcal{M}) = \text{rank}(\mathcal{M})$ . Let  $B \subseteq E$  be a basis of  $\mathcal{M}$ , hence  $|B| = r$ . By Corollary 0.5.10  $\text{rank}(\mathcal{M}^*) = \text{rank}(\mathcal{M}^*) = n - r$ , hence it is sufficient to show  $\text{rank}_{\mathcal{M}^*}(E \setminus B) = n - r$ . By Corollary 0.4.6 (i)  $\text{rank}_{\mathcal{M}^*}(E \setminus B) = \text{rank}(\mathcal{M}^* \setminus B)$ , and by Lemma 0.5.2  $\text{rank}(\mathcal{M}^* \setminus B) = \text{rank}((\mathcal{M}/B)^*)$ . Then Corollary 0.5.10 implies  $\text{rank}((\mathcal{M}/B)^*) = |E \setminus B| - \text{rank}(\mathcal{M}/B) = n - r$  since  $\text{rank}(\mathcal{M}/B) = 0$  as  $B$  is a basis of  $\mathcal{M}$  (see also Corollary 0.4.6 (ii)). Let  $B \subseteq E$  be such that  $E \setminus B$  is a basis of  $\mathcal{M}^*$ . By the above result is  $B = E \setminus (E \setminus B)$  a basis of  $\mathcal{M}^{**} = \mathcal{M}$  (cf. Proposition 0.5.8). ■



## 0.6 Cocircuits

We have a first look at cocircuits, the minimal covectors w.r.t.  $\leq$  in  $\mathcal{F} \setminus \mathbf{0}$ . In an oriented matroid defined by a sphere arrangement as introduced in Section 0.1, cocircuits correspond to cells of dimension 0. We show several properties of cocircuits, especially that the set of cocircuits determines the set of covectors, and that sets of cocircuits can be characterized by axioms, i.e., there are cocircuit axioms which are equivalent to the covector axioms of oriented matroids.

**0.6.1 Definition (Cocircuits)** For an oriented matroid  $\mathcal{M} = (E, \mathcal{F})$  we call

$$\mathcal{D} := \min(\mathcal{F} \setminus \mathbf{0}) = \{V \in \mathcal{F} \mid \text{for all } X \in \mathcal{F} \setminus \mathbf{0} \text{ such that } X \leq V \text{ is } X = V\}$$

the set of *cocircuits* of  $\mathcal{M}$ .

Many of the following results come from (at least similar) results in [BLV78]:

**0.6.2 Lemma** *Let  $\mathcal{M} = (E, \mathcal{F})$  be an oriented matroid,  $X \in \mathcal{F}$ , and  $e \in \underline{X}$ . There exists a cocircuit  $V \in \mathcal{D}$  of  $\mathcal{M}$  such that  $V \leq X$  and  $V_e = X_e$ .*

**Proof** Let  $\mathcal{M} = (E, \mathcal{F})$  be an oriented matroid,  $X \in \mathcal{F}$ , and  $e \in \underline{X}$ . Consider the set  $\tilde{\mathcal{F}} := \{Y \in \mathcal{F} \mid Y \leq X \text{ and } Y_e = X_e\}$  which is not empty since  $X \in \tilde{\mathcal{F}}$ . We have to show that  $\tilde{\mathcal{F}}$  contains a cocircuit. Let  $V \in \tilde{\mathcal{F}}$  be minimal w.r.t. the conformal relation  $\leq$ , i.e., there is no  $Y \in \tilde{\mathcal{F}}$  with  $Y < V$ . We show that  $V \notin \mathcal{D}$  leads to a contradiction. Assume that there exists  $W \in \mathcal{F} \setminus \mathbf{0}$  with  $W < V \leq X$ . Because of the minimality of  $V$  in  $\tilde{\mathcal{F}}$  we conclude  $W_e = 0$ . Remark that  $D(V, -W) = \underline{W} \neq \emptyset$ , therefore conformal elimination (F3<sup>c</sup>) w.r.t.  $V, -W$ , and  $D := D(V, -W)$  implies that there exist  $f \in D$  and  $Z \in \mathcal{F}$  such that  $Z_f = 0$ ,  $Z_D \leq V_D$ , and  $Z \setminus D = (V \circ (-W)) \setminus D$ . From this follows  $Z \leq V$  (otherwise there exists  $g \in E \setminus D$  such that  $0 \neq Z_g \neq V_g$ , hence  $V_g = 0$  and  $Z_g = -W_g \neq 0$ , in contradiction to  $W_g \leq V_g$ ),  $Z \neq V$  (since  $Z_f = 0 \neq V_f$ ) and  $Z_e = X_e$  (because of  $W_e = 0$  is  $Z_e = (V \circ (-W))_e = V_e = X_e \neq 0$ ). But  $Z$  contradicts the minimality of  $V$  in  $\tilde{\mathcal{F}}$ , which completes the proof. ■

**0.6.3 Proposition (Conformal Decomposition [BLV78])** *Let  $\mathcal{M} = (E, \mathcal{F})$  be an oriented matroid. Every covector  $X \in \mathcal{F} \setminus \mathbf{0}$  has a representation of the form*

$$X = V^1 \circ V^2 \circ \dots \circ V^\ell,$$

where each  $V^i$  is a cocircuit of  $\mathcal{M}$  conforming to  $X$ , i.e.,  $V^i \in \mathcal{D}$  and  $V^i \leq X$  for all  $i \in \{1, \dots, \ell\}$ ; there is always such a conformal decomposition of  $X$  with  $\ell \leq |\underline{X}|$ .

**Proof** Let  $\mathcal{M} = (E, \mathcal{F})$  be an oriented matroid and  $X \in \mathcal{F} \setminus \mathbf{0}$ . By Lemma 0.6.2 there exists for every  $e \in \underline{X}$  a cocircuit  $V^e \in \mathcal{D}$  such that  $V^e \leq X$  and  $V^e_e = X_e$ . Obviously it is sufficient to set  $\{V^1, V^2, \dots, V^\ell\} := \{V^e \mid e \in \underline{X}\}$ . ■

**0.6.4 Corollary (Cocircuits Determine Covectors)** *The set  $\mathcal{D}$  of cocircuits of an oriented matroid  $\mathcal{M} = (E, \mathcal{F})$  determines the set of covectors by*

$$\mathcal{F} = \{X \mid X = V^1 \circ V^2 \circ \dots \circ V^\ell \text{ for } V^i \in \mathcal{D} \text{ such that } V^i \leq X, \ell \geq 1\} \cup \{\mathbf{0}\}.$$

**Proof** The covector composition axiom (F2) makes sure that every composition of cocircuits is in  $\mathcal{F}$ , on the other hand conformal decomposition (Proposition 0.6.3) proves that every covector (except  $\mathbf{0}$ ) can be generated by composition of cocircuits  $V^i$  with  $V^i \preceq X$ . ■

**0.6.5 Definition (Cocircuit Axioms)** Let  $E$  be a finite set and  $\mathcal{D} \subseteq \{-, +, 0\}^E$  a set of sign vectors on  $E$ . We say that  $\mathcal{D}$  is a set of cocircuits if and only if the following cocircuit axioms (C0) to (C3) are valid:

(C0)  $\mathbf{0} \notin \mathcal{D}$ .

(C1) If  $X \in \mathcal{D}$  then  $-X \in \mathcal{D}$ . (symmetry)

(C2) If  $X, Y \in \mathcal{D}$  such that  $\underline{X} \subseteq \underline{Y}$  then  $X = Y$  or  $X = -Y$ . (minimality of support)

(C3) For all  $X, Y \in \mathcal{D}$  with  $X \neq -Y$  and  $e \in D(X, Y)$  there exists  $Z \in \mathcal{D}$  such that  
 $Z_e = 0$  and  
 $Z_f \in \{X_f, Y_f, 0\}$  for all  $f \in E$ . (cocircuit elimination)

**0.6.6 Proposition (Strong Cocircuit Elimination [BLV78, FL78])** Let  $\mathcal{D}$  be a set of sign vectors on  $E$  satisfying (C0), (C1), and (C2). Then (C3) is equivalent to

(C3<sup>s</sup>) For all  $X, Y \in \mathcal{D}$  and  $e \in D(X, Y)$  and  $f \in \underline{X} \setminus D(X, Y)$  there exists  $Z \in \mathcal{D}$  such that  
 $Z_e = 0$  and  
 $Z_f = X_f$  and  
 $Z_g \in \{X_g, Y_g, 0\}$  for all  $g \in E$ . (strong cocircuit elimination)

**Proof** We refer to the proof of Theorem 3.2.5 in [BLVS<sup>+</sup>99]. ■

The above set of cocircuit axioms of oriented matroids are usually taken as the defining set of axioms of oriented matroids (as it was the case in the original work of Bland and Las Vergnas [BLV78]). We have chosen the covector axioms for the definition of oriented matroids. The study of covector axioms is mainly due to Edmonds, Fukuda, and Mandel (see [Fuk82, Man82]).

**0.6.7 Proposition** A set  $\mathcal{D}$  of sign vectors satisfies the cocircuit axioms (C0) to (C3) if and only if it is the set of cocircuits of an oriented matroid.

**Proof** Let  $\mathcal{D}$  be a set of cocircuits of an oriented matroid  $(E, \mathcal{F})$ , and we show that (C0) to (C3) are satisfied. (C0) follows by definition and (C1) from the symmetry if  $\mathcal{F}$ . For (C2) consider  $X, Y \in \mathcal{D} \subseteq \mathcal{F}$  with  $\underline{X} \subseteq \underline{Y}$ . If  $D(X, Y) = \emptyset$  then  $X \preceq Y$ , and by definition  $X = Y$ . If  $D(X, Y) \neq \emptyset$  then by conformal elimination (F3<sup>c</sup>) there exist  $e \in D := D(Y, X)$  and  $Z \in \mathcal{F}$  such that  $Z_e = 0$  and  $Z_D \preceq Y_D$  and  $Z_f = (Y \circ X)_f$  for all  $f \in E \setminus D$ . By  $\underline{X} \subseteq \underline{Y}$  and  $Z_e = 0 \neq Y_e$  follows  $Z \prec Y$ , hence  $Z = \mathbf{0}$ . Then  $X \setminus D = Y \setminus D = \mathbf{0}$ , so  $X = -Y$ . (C3) finally follows from (F3).

Let  $\mathcal{D}$  be a set of cocircuits, i.e.,  $\mathcal{D}$  satisfies (C0) to (C3). Define  $\mathcal{F}$  according to Corollary 0.6.4. We show that  $\mathcal{F}$  satisfies the covector axioms (F0) to (F3), i.e.,  $(E, \mathcal{F})$  is an oriented matroid whose set of cocircuits obviously is  $\mathcal{D}$ . (F0) and (F1) follow by definition and the symmetry in  $\mathcal{D}$ . In order to show (F2) we prove that  $\mathcal{F}$  is equal to

$$\tilde{\mathcal{F}} := \{X \mid X = V^1 \circ V^2 \circ \dots \circ V^\ell \text{ for } V^i \in \mathcal{D}, \ell \geq 1\} \cup \{\mathbf{0}\}.$$

Obviously  $\mathcal{F} \subseteq \tilde{\mathcal{F}}$ . Let be  $X \in \tilde{\mathcal{F}}$ , we show that  $X \notin \mathcal{F}$  leads to a contradiction, hence  $\tilde{\mathcal{F}} \subseteq \mathcal{F}$ . Assume  $X \notin \mathcal{F}$ , hence  $X \neq \mathbf{0}$ , i.e.,  $X$  is of the form  $X = V^1 \circ \dots \circ V^\ell$  for  $V^i \in \mathcal{D}$  and some  $\ell \geq 1$ . Obviously there exists  $X' \in \mathcal{F} \setminus \{\mathbf{0}\}$  such that  $X' \preceq X$ , and we can choose such a  $X'$  with maximal  $|\underline{X}'|$ ; then  $X' \prec X$ . For the smallest  $i \in \{1, \dots, \ell\}$  with  $\underline{V}^i \not\subseteq \underline{X}'$  is  $X' \prec X \circ V^i = X$ , hence we can choose some  $V \in \mathcal{D}$  with  $X' \prec X' \circ V \preceq X$  such that  $|D(V, X)|$  is minimal. If  $D(V, X) = \emptyset$  then  $V \preceq X$  and hence  $X' \prec X' \circ V \in \mathcal{F}$ , contradicting the maximality of  $|\underline{X}'|$ . So there exist  $e \in D(V, X) \subseteq \underline{X}'$  and  $f \in \underline{V} \setminus \underline{X}'$ . By definition of  $\mathcal{F}$  there exist  $W^i \in \mathcal{D}$  with  $W^i \preceq X'$  and  $X' = W^1 \circ \dots \circ W^k$  for some  $k \geq 1$ , and then  $e \in D(V, W^j)$  for some  $W^j$ . By the strong cocircuit elimination (C3<sup>s</sup>) (see Proposition 0.6.6) applied to  $V, W^j, e$ , and  $f \in \underline{V} \setminus D(V, W^j)$  there exists  $V' \in \mathcal{D}$  such that  $V'_e = 0$  and  $V'_f = V_f$  and  $V'_g \in \{V_g, W_g^j, 0\}$  for all  $g \in E$ , so  $D(V', X) \subseteq D(V, X) \setminus e$ , but since  $X' \prec X' \circ V' \preceq X$  this contradicts the minimality of  $|D(V, X)|$ . For (F3) it is sufficient to prove (F3<sup>w</sup>) (see Proposition 0.2.2). Let be  $X, Y \in \mathcal{F}$ ,  $e \in D(X, Y)$ , and  $f \in \underline{X} \setminus D(X, Y)$ . By definition there exists  $V \in \mathcal{D}$  such that  $V_f = X_f$  and  $V \preceq X$ . If  $V_e = 0$  then this proves (F3<sup>w</sup>), otherwise  $V_e = X_e$ . Again by definition, there exists  $W \in \mathcal{D}$  such that  $W_e = Y_e$  and  $W \preceq Y$ . Apply (C3<sup>s</sup>) to  $V, W, e$ , and  $f \in \underline{V} \setminus D(V, W)$ : There exists  $Z \in \mathcal{D} \subseteq \mathcal{F}$  such that  $Z_e = 0$ ,  $Z_f = V_f = X_f$ , and for all  $g \in E$  is  $Z_g \in \{V_g, W_g, 0\} \subseteq \{X_g, Y_g, 0\}$ . ■

We introduce in the following a stronger elimination axiom which will be used in Chapter 5 for the discussion of single element extensions.

**0.6.8 Definition (Modular)** Let  $\mathcal{D}$  be a set of sign vectors such that  $\{X^0 \mid X \in \mathcal{D}\}$  is the set of hyperplanes of a matroid  $M$ . Then we call  $X, Y \in \mathcal{D}$  *modular in  $M$*  if  $X^0 \cap Y^0$  is a coline (i.e.,  $\text{rank}_M(X^0 \cap Y^0) = \text{rank}(M) - 2$ ).

The above definition e.g., applies to sets of cocircuits.

**0.6.9 Proposition (Modular Cocircuit Elimination [LV78b, LV84])** *A set  $\mathcal{D}$  of sign vectors is a set of cocircuits if and only if  $\{X^0 \mid X \in \mathcal{D}\}$  is the set of hyperplanes of a matroid  $M$  and  $\mathcal{D}$  satisfies the cocircuit axioms (C0), (C1), (C2), and*

$$\begin{aligned} \text{(C3}^m\text{)} \quad & \text{For all } X, Y \in \mathcal{D} \text{ which are modular in } M \text{ and } e \in D(X, Y) \\ & \text{there exists } Z \in \mathcal{D} \text{ such that} \\ & Z_e = 0 \text{ and} \\ & Z_f \in \{X_f, Y_f, 0\} \text{ for all } f \in E. \end{aligned} \quad \text{(modular cocircuit elimination)}$$

**Proof** It is clear that (C3) implies (C3<sup>m</sup>). Let  $\mathcal{D}$  be a set of sign vectors on  $E$  which satisfies (C0), (C1), (C2), and (C3<sup>m</sup>), and in addition assume that  $\{X^0 \mid X \in \mathcal{D}\}$  is the

set of hyperplanes of a matroid  $M$ . If  $\text{rank}(M) = 1$  then (C3) is trivially fulfilled, and if  $\text{rank}(M) = 2$  then every two cocircuits with distinct support are modular in  $M$ , hence assume  $\text{rank}(M) \geq 3$ , so also  $|E| \geq 3$ . The proof that (C3) holds is by induction on the cardinality  $|E|$  of the ground set. For  $g \in E$  set

$$\mathcal{D}^{(\setminus g)} := \begin{cases} \{X \setminus g \mid X \in \mathcal{D} \text{ such that } \text{span}_M(X^0 \setminus g) \neq X^0\} & \text{if } g \text{ is a coloop of } M, \\ \{X \setminus g \mid X \in \mathcal{D} \text{ such that } \text{span}_M(X^0 \setminus g) = X^0\} & \text{otherwise.} \end{cases}$$

and  $\mathcal{D}/g := \{X_{E \setminus g} \mid X \in \mathcal{D} \text{ such that } X_g = 0\}$ . Observe that the zero supports of  $\mathcal{D}^{(\setminus g)}$  and  $\mathcal{D}/g$  are the sets of hyperplanes of  $M \setminus g$  and  $M/g$ , respectively (see Corollary 0.4.9 (iii) and (iv)); so if  $\mathcal{D}$  is a set of cocircuits then  $\mathcal{D}^{(\setminus g)}$  and  $\mathcal{D}/g$  are the sets of cocircuits of the deletion and contraction minors w.r.t.  $g$ .

We show now that  $\mathcal{D}^{(\setminus g)}$  and  $\mathcal{D}/g$  satisfy (C0), (C1), (C2), and (C3<sup>m</sup>), hence by induction also (C3). Since  $\mathcal{D}^{(\setminus g)} = \mathcal{D}/g$  if  $g$  is a coloop of  $M$  (note that then there is a cocircuit  $X \in \mathcal{D}$  with  $\underline{X} = \{g\}$  what implies by (C2)  $Y_g = 0$  for all  $Y \in \mathcal{D} \setminus \{X, -X\}$ ), the only nontrivial case is the proof that  $\mathcal{D}^{(\setminus g)}$  satisfies (C3<sup>m</sup>) when  $g$  is not a coloop. Let be  $X', Y' \in \mathcal{D}^{(\setminus g)}$  modular in  $M \setminus g$  and  $e \in D(X', Y')$ . Let  $X, Y$  be the unique sign vectors in  $\mathcal{D}$  such that  $X \setminus g = X'$  and  $Y \setminus g = Y'$ ; uniqueness is implied by (C2).  $X$  and  $Y$  are modular in  $M$  if and only if  $\text{span}_M((X^0 \cap Y^0) \setminus g) = X^0 \cap Y^0$  (Corollary 0.4.9 (iii)), which is clear unless  $g \in X^0 \cap Y^0$ , but then  $X^0 \cap Y^0$  must be a coline since otherwise there exists  $H \in M$  such that  $X^0 \cap Y^0 \subsetneq H \subsetneq X^0$ , hence  $g \in H$  and  $(X^0 \cap Y^0) \setminus g \subsetneq H \setminus g \subsetneq X^0 \setminus g$  contradicts that  $X', Y'$  are modular in  $M \setminus g$ . Therefore are  $X$  and  $Y$  modular in  $M$  and  $e \in D(X, Y)$ , and by (C3<sup>m</sup>) there exists  $Z \in \mathcal{D}$  such that  $Z_e = 0$  and  $Z_f \in \{X_f, Y_f, 0\}$  for all  $f \in E$ , especially  $X^0 \cap Y^0 \subseteq Z^0$ . Remark that  $\text{span}_M(Z^0 \setminus g) = Z^0$  (otherwise  $g \in Z^0$  and  $Z^0 \setminus g \in M$  is a coline which is identical to  $X^0 \cap Y^0$  because of  $X^0 \cap Y^0 = \text{span}_M((X^0 \cap Y^0) \setminus g) \subseteq \text{span}_M(Z^0 \setminus g) = Z^0 \setminus g$ , in contradiction to  $Z^0 \ni e \notin X^0 \cap Y^0$ ). So  $Z \setminus g \in \mathcal{D}^{(\setminus g)}$ , which is sufficient to show (C3<sup>m</sup>) for  $\mathcal{D}^{(\setminus g)}$ .

Let be  $X, Y \in \mathcal{D}$  with  $X \neq -Y$  and  $e \in D(X, Y)$ . Remark that  $\text{rank}(M) \geq 3$  implies  $|X^0| \geq \text{rank}_M(X^0) = \text{rank}(M) - 1 \geq 2$  and similarly  $|Y^0| \geq 2$ . If  $\underline{X} \cup \underline{Y} \neq E$  then for  $g \in X^0 \cap Y^0$  find  $Z' \in \mathcal{D}/g$  such that  $Z'_e = 0$  and  $Z'_f \in \{X_f, Y_f, 0\}$  for all  $f \in E \setminus g$ . Then  $Z \in \mathcal{D}$  with  $Z \setminus g = Z'$  is sufficient to prove (C3). Otherwise we can assume  $\rightsquigarrow \underline{X} \cup \underline{Y} = E$ .

Let be  $g \in \underline{X}$ . If  $g$  is a coloop of  $M$  then  $X^0 = E \setminus g$  (since  $X^0 \subseteq E \setminus g$  is a hyperplane), and then  $\underline{X} \cup \underline{Y} = E$  implies  $Y^0 = \{g\}$ , a contradiction to  $|Y^0| \geq 2$ . So,  $g$  is not a coloop of  $M$ , and  $g \in \underline{X}$  implies  $X \setminus g \in \mathcal{D}^{(\setminus g)}$ . This and symmetry in  $X$  and  $Y$  proves that  $\rightsquigarrow X \setminus g \in \mathcal{D}^{(\setminus g)}$  for all  $g \in \underline{X}$ , and  $Y \setminus g \in \mathcal{D}^{(\setminus g)}$  for all  $g \in \underline{Y}$ .

Let be  $g \in (\underline{X} \cap \underline{Y}) \setminus e$ , hence  $X' := X \setminus g$  and  $Y' := Y \setminus g$  in  $\mathcal{D}^{(\setminus g)}$ , which is a set of cocircuits. As  $X' \neq -Y'$  and  $e \in D(X', Y')$ , one can apply cocircuit elimination to  $X', Y'$ , and  $e$ : There exists  $Z' \in \mathcal{D}^{(\setminus g)}$  such that  $Z'_e = 0$  and  $Z'_f \in \{X'_f, Y'_f, 0\}$  for all  $f \in E \setminus g$ . Let be  $Z \in \mathcal{D}$  such that  $Z \setminus g = Z'$ . Then  $Z_e = 0$  and  $Z_f \in \{X_f, Y_f, 0\}$  for all  $f \in E \setminus g$ . If for some  $g \in (\underline{X} \cap \underline{Y}) \setminus e$  one finds  $Z_g \in \{X_g, Y_g, 0\}$  then (C3) is satisfied. Otherwise  $Z_g \notin \{X_g, Y_g, 0\}$  for all  $g \in (\underline{X} \cap \underline{Y}) \setminus e$  hence  $\rightsquigarrow D(X, Y) = \{e\}$ .

Let be  $g \in X^0 \subseteq \underline{Y}$ . Since  $|X^0| \geq 2$  there exists  $f \in X^0 \setminus g$ .  $X \setminus f \neq \mathbf{0}$  is a covector in

the oriented matroid defined by  $\mathcal{D}^{(\setminus g)}$ , so by Lemma 0.6.2 there exists  $X' \in \mathcal{D}^{(\setminus g)}$  such that  $X' \preceq X \setminus f$  and  $X'_e = X_e$ . As showed above,  $Y' := Y \setminus g \in \mathcal{D}^{(\setminus g)}$ . By cocircuit elimination in  $\mathcal{D}^{(\setminus g)}$  applied to  $X', Y'$ , and  $e$  there exists  $Z' \in \mathcal{D}^{(\setminus g)}$  such that  $Z'_e = 0$  and  $Z'_f \in \{X'_f, Y'_f, 0\}$  for all  $f \in E \setminus g$ . Let be  $Z \in \mathcal{D}$  such that  $Z \setminus g = Z'$ . Then  $Z_e = 0$  and  $Z_f \in \{X_f, Y_f, 0\}$  for all  $f \in E \setminus g$ , and because of  $D(X, Y) = \{e\}$  is  $Z_f \preceq X \circ Y$  for all  $f \in E \setminus g$ . Either  $Z$  is sufficient to prove (C3), or  $Z_g \notin \{X_g, Y_g, 0\} = \{Y_g, 0\}$  and hence  $g \in D(X \circ Y, Z)$ . If this case occurs for all  $g \in X^0$  then

$\rightsquigarrow$  for all  $g \in X^0$  there exists  $Z \in \mathcal{D}$  such that  $Z_e = 0$  and  $D(X \circ Y, Z) = \{g\}$ .

Let be  $g \in X^0$  and  $Z \in \mathcal{D}$  such that  $Z_e = 0$  and  $D(X \circ Y, Z) = \{g\}$ . If  $Y^0 \cap Z^0 = \emptyset$  let be  $h \in Y^0 \subseteq \underline{Z}$ . Again, as before, there exists  $\hat{Z} \in \mathcal{D}$  such that  $\hat{Z}_e = 0$  and  $D(X \circ Y, \hat{Z}) = \{h\}$ . As  $\hat{Z} = -Z$  would imply  $\underline{Z} = \{g, h\}$  and  $Y^0 \cap Z^0 = Y^0 \setminus g \neq \emptyset$ , we can assume  $\hat{Z} \neq -Z$ . By cocircuit elimination in  $\mathcal{D}/e$  applied to  $Z \setminus e, \hat{Z} \setminus e$ , and  $h$  and lifting the resulting vector, there exists  $Z' \in \mathcal{D}$  such that  $Z'_e = 0, Z'_h = 0$ , and  $Z'_f \in \{Z_f, \hat{Z}_f, 0\}$  for all  $f \in E$ , which implies  $Z'_f \in \{X_f, Y_f, 0\}$  for all  $f \in E \setminus g$ . Either  $Z'$  proves (C3), or  $Z'_g \notin \{X_g, Y_g, 0\} = \{Y_g, 0\}$  and  $D(X \circ Y, Z') = \{g\}$ , and then set  $Z := Z' \in \mathcal{D}$ , hence  $Z_e = 0, D(X \circ Y, Z) = \{g\}$ , and  $Y^0 \cap Z^0 = \{h\} \neq \emptyset$ .

Let be  $h \in Y^0 \cap Z^0$ . Apply cocircuit elimination in  $\mathcal{D}/h$  to  $Y \setminus h, Z \setminus h$ , and  $g$  and lift the resulting vector to  $\mathcal{D}$ : There exists  $Y' \in \mathcal{D}$  such that  $Y'_h = 0, Y'_g = 0$ , and  $Y'_f \in \{Y_f, Z_f, 0\}$  for all  $f \in E$ , hence  $Y'_f \in \{X_f, Y_f, 0\}$  for all  $f \in E \setminus e$ . Either  $Y'_e = 0$  which completes the proof, or  $Y'_e \neq 0$ , i.e.,  $Y'_e = Y_e$ . Then apply cocircuit elimination in  $\mathcal{D}/g$  to  $X \setminus g, Y' \setminus g$ , and  $e$  and lift the resulting vector to  $\mathcal{D}$ : There exists  $Z' \in \mathcal{D}$  such that  $Z'_g = 0, Z'_e = 0$ , and  $Z'_f \in \{X_f, Y'_f, 0\}$  for all  $f \in E$ , which finally proves (C3). ■

## 0.7 Topes and the Big Face Lattice

This section introduces topes, the maximal covectors in  $\mathcal{F}$ . W.r.t. a sphere arrangement as introduced in Section 0.1, topes correspond to regions of maximal dimension. We discuss the facial relationship of the covectors, resulting in the definition of the (big) face lattice, and prove important properties of this face lattice. The naming of *topes* follows Edmonds, Fukuda, and Mandel (see [Fuk82, Man82]).

**0.7.1 Definition (Topes)** For an oriented matroid  $\mathcal{M} = (E, \mathcal{F})$  we call

$$\mathcal{T} := \max(\mathcal{F}) = \{T \in \mathcal{F} \mid \text{for all } X \in \mathcal{F} \text{ such that } T \preceq X \text{ is } T = X\}$$

the set of *topes* of  $\mathcal{M}$ .

An obvious characterization of topes (within a set of covectors) is the following:

**0.7.2 Lemma** *A covector  $X \in \mathcal{F}$  is a tope if and only if  $X^0$  is the set of loops of  $\mathcal{M}$ .*

**Proof** Let  $\mathcal{M} = (E, \mathcal{F})$  be an oriented matroid and  $X \in \mathcal{F}$ . Let  $E^0$  denote the set of loops of  $\mathcal{M}$ . Obviously  $E^0 \subseteq X^0$ . If  $E^0 \subsetneq X^0$  let be  $g \in X^0 \setminus E^0$  and  $Y \in \mathcal{F}$  such that  $Y_g \neq 0$ . Then  $X < X \circ Y$ , hence  $X$  is not a tope. On the other hand, if  $X \in \mathcal{F}$  is not a tope then its zero support is obviously not equal to  $E^0$ . ■

The following is an unpublished result of Mandel (see Theorem 1.1. in [Cor85a, Cor85b]), where our proof is similar to one in [Fuk00b]:

**0.7.3 Proposition (Topes Determine Covectors)** *The set  $\mathcal{T}$  of topes of an oriented matroid  $\mathcal{M} = (E, \mathcal{F})$  determines the set of covectors by*

$$\mathcal{F} = \{X \in \{-, +, 0\}^E \mid X \circ T \in \mathcal{T} \text{ for all } T \in \mathcal{T}\}.$$

**Proof** Let  $(E, \mathcal{F})$  be an oriented matroid and  $\mathcal{T}$  its tope set. If  $X \in \mathcal{F}$  then (F2) implies  $X \circ T \in \mathcal{F}$  for every tope  $T \in \mathcal{T}$ , and by Lemma 0.7.2 we conclude that  $X \circ T \in \mathcal{T}$ .

For the other direction consider  $X \in \{-, +, 0\}^E$  with the property that  $X \circ T \in \mathcal{T}$  for all  $T \in \mathcal{T}$ ; we have to show that  $X \in \mathcal{F}$ . We will prove that  $X \circ Y \in \mathcal{F}$  for all  $Y \in \mathcal{F}$ ; the proof is by induction on  $|(X \circ Y)^0|$ , and the claim finally will follow for  $|(X \circ Y)^0| = |X^0|$  since then  $X \circ Y = X \in \mathcal{F}$ .

Consider first  $Y \in \mathcal{F}$  with  $|(X \circ Y)^0|$  minimal: Let  $Z \in \mathcal{T}$  be any tope with  $Y \preceq Z$ , then the minimality of  $|(X \circ Y)^0|$  implies  $X \circ Y = X \circ Z \in \mathcal{F}$ .

For the inductive step consider  $Y \in \mathcal{F}$  with  $|(X \circ Y)^0|$  not minimal and assume that  $X \circ Z \in \mathcal{F}$  for all  $Z \in \mathcal{F}$  with  $|(X \circ Y)^0| > |(X \circ Z)^0|$ . It is clear that there exists  $Z \in \mathcal{F}$  with  $|(X \circ Y)^0| > |(X \circ Z)^0|$  and  $X \circ Y \preceq X \circ Z$ , i.e.,  $X \circ Y \prec X \circ Z \in \mathcal{F}$ ; we can assume that there is no  $Z' \in \mathcal{F}$  such that  $X \circ Y \prec X \circ Z' \prec X \circ Z$ . Composition of  $Y \in \mathcal{F}$  and  $Z \in \mathcal{F}$  gives  $Y \circ Z \in \mathcal{F}$  with  $|(X \circ Y)^0| > |(X \circ Z)^0| \geq |(X \circ Y \circ Z)^0|$ , hence  $W^+ := X \circ Y \circ Z \in \mathcal{F}$  and similarly  $W^- := X \circ Y \circ (-Z) \in \mathcal{F}$ . From  $X \circ Y \prec X \circ Y \circ Z$  follows  $D := D(W^+, W^-) \neq \emptyset$ , and by conformal elimination applied to  $W^+$ ,  $W^-$ , and  $D$  there exists  $e \in D$  and  $W \in \mathcal{F}$  such that  $W_e = 0$  and  $W_D \preceq W_D^+$  and  $W_f = (W^+ \circ W^-)_f = W_f^+$  for all  $f \in E \setminus D$ , hence  $W \preceq W^+$ . Remark (for the first and last equality of what follows) that  $\underline{X} \subseteq E \setminus D$  and  $X \circ Y \preceq X \circ Z$ :

$$X \circ W = W \preceq W^+ = X \circ Y \circ Z = X \circ Z.$$

Furthermore  $e \in (X^0 \cup W^0) \setminus Z^0$  implies  $X \circ W \prec X \circ Z$ . On the other hand it is easy to see that  $X \circ Y \preceq X \circ W$ , and finally the above assumption on  $Z$  implies that  $X \circ Y = X \circ W = W \in \mathcal{F}$ .  $\blacksquare$

The following investigations of covectors and their facial relationship have been presented explicitly in [Fuk82, Man82] and partially or implicitly in [FL78, LV80].

We extend the notion of a loop to arbitrary sets of signs vectors and define the notion of parallel elements:

**0.7.4 Definition (Loop, Parallel)** Let  $\mathcal{F}$  be a set of sign vectors on a finite ground set  $E$ . An element  $e \in E$  is called a *loop of  $\mathcal{F}$*  if  $X_e = 0$  for all  $X \in \mathcal{F}$ . Two elements  $e, f \in E$  are called *parallel elements of  $\mathcal{F}$*  if either  $X_e = X_f$  for all  $X \in \mathcal{F}$  or  $X_e = -X_f$  for all  $X \in \mathcal{F}$ . Parallelness is an equivalence relation and defines the *parallel classes of  $\mathcal{F}$* .

Note that for oriented matroids the new definition of a loop falls together with the former one in the following sense: if  $\mathcal{M} = (E, \mathcal{F})$  is an oriented matroid with set of cocircuits  $\mathcal{D}$  and set of topes  $\mathcal{T}$ , then all the following statements for  $e \in E$  are equivalent:  $e$  is a loop of  $\mathcal{M}$ ,  $e$  is a loop of  $\mathcal{F}$ ,  $e$  is a loop of  $\mathcal{D}$ ,  $e$  is a loop of  $\mathcal{T}$ . Parallel classes can be characterized in oriented matroids as follows:

**0.7.5 Lemma** *Let  $(E, \mathcal{F})$  be an oriented matroid. Two elements  $e, f \in E$  are parallel elements of  $\mathcal{F}$  if and only if there exists no  $X \in \mathcal{F}$  such that exactly one of  $X_e$  and  $X_f$  is equal to 0.*

**Proof** If for some  $X \in \mathcal{F}$  exactly one of  $X_e$  and  $X_f$  is equal to 0 then  $e$  and  $f$  are not parallel by definition. On the other hand, consider  $e$  and  $f$  that are not parallel, hence either there exists  $X \in \mathcal{F}$  such that exactly one of  $X_e$  and  $X_f$  is equal to 0 (which would prove the claim) or there exist  $X, Y \in \mathcal{F}$  such that  $X_e = X_f \neq 0$  and  $Y_e = -Y_f \neq 0$ . After possibly interchanging  $e$  and  $f$  we can assume  $X_e = -Y_e \neq 0$  and  $X_f = Y_f \neq 0$ . By weak elimination (F3<sup>w</sup>) there exists  $Z \in \mathcal{F}$  such that  $Z_e = 0$  and  $Z_f = X_f \neq 0$ , which proves the claim. ■

The next lemma is the base of the investigation of the facial relationship in connection with the rank of covectors:

**0.7.6 Lemma** *Let  $(E, \mathcal{F})$  be an oriented matroid and  $X, Y \in \mathcal{F}$  such that  $X \prec Y$ . Then the following three statements are equivalent:*

- (i)  $X^0 \setminus Y^0$  a parallel class of  $\mathcal{F}/Y^0$ .
- (ii)  $\text{rank}_{\mathcal{M}}(Y) - \text{rank}_{\mathcal{M}}(X) = 1$ .
- (iii) There is no  $Z \in \mathcal{F}$  with  $X \prec Z \prec Y$ .

**Proof** We proof the equivalence of the negated statements.

If  $S := X^0 \setminus Y^0$  is not a parallel class of  $\mathcal{F}/Y^0$  then by Lemma 0.7.5 there exist  $e, f \in S$  and  $Z \in \mathcal{F}$  such that  $Y^0 \subseteq Z^0$  and exactly one of  $Z_e$  and  $Z_f$  is equal to 0. But then  $X^0 \supsetneq X^0 \cap Z^0 \supsetneq Y^0$ , hence  $1 < \text{rank}_{\underline{\mathcal{M}}}(X^0) - \text{rank}_{\underline{\mathcal{M}}}(Y^0) = \text{rank}_{\mathcal{M}}(Y) - \text{rank}_{\mathcal{M}}(X)$ .

If  $\text{rank}_{\mathcal{M}}(Y) - \text{rank}_{\mathcal{M}}(X) > 1$  then by Lemma 0.3.7 (vi) every basis  $B$  of  $Y^0$  in  $\underline{\mathcal{M}}$  can be augmented by  $e \in X^0 \setminus Y^0$  such that  $B \cup e$  is an independent subset of  $X^0$ , and then  $X^0 \supsetneq \overline{B \cup e} \supsetneq Y^0$ . There exists  $\tilde{Z} \in \mathcal{F}$  such that  $\tilde{Z}^0 = \overline{B \cup e}$ . Set  $Z' := X \circ \tilde{Z} \in \mathcal{F}$ , then  $X \preceq Z'$  and  $(Z')^0 = \overline{B \cup e}$ . If  $D := D(Y, Z') = \emptyset$  then  $Z' \prec Y$ , which proves the negation of (iii). Otherwise  $D \neq \emptyset$ , and we can apply conformal elimination (F3<sup>c</sup>) to  $Y, Z'$ , and  $D$ : there exist  $e \in D$  and  $Z \in \mathcal{F}$  such that  $Z_e = 0, Z_D \preceq Y_D$  and  $Z \setminus D = (Y \circ Z') \setminus D$ . Then  $(Z')^0 \supseteq Y^0$  implies  $Z \setminus D = Y \setminus D$  and by  $D \subseteq \underline{Y} \setminus \underline{X}$  also  $X \prec X \circ Z \prec Y$ , which proves that (iii) is not valid.

If there exists  $Z \in \mathcal{F}$  with  $X \prec Z \prec Y$  then there exist  $e, f \in S := X^0 \setminus Y^0$  with  $e \in Z^0 \not\cong f$ , and by Lemma 0.7.5 is  $S$  not a parallel class of  $\mathcal{F}/Y^0$ . ■

Before we investigate the face lattice of an oriented matroid we state the following so-called *reorientation property* or *shelling property* of tope sets:

**0.7.7 Corollary** *Let  $(E, \mathcal{F})$  be an oriented matroid and  $\mathcal{T}$  its set of topes. Then for all  $X, Y \in \mathcal{T}$  with  $X \neq Y$  there exists a parallel class  $S \subseteq D(X, Y)$  such that  $\overline{S}X \in \mathcal{T}$ .*

**Proof** Let be  $X, Y \in \mathcal{T}$  such that  $X \neq Y$ . Let  $E^0$  denote the set of loops of  $\mathcal{M}$ . By Lemma 0.7.2  $\underline{X} = \underline{Y} = E \setminus E^0$ , so  $D(X, Y) \neq \emptyset$ . We apply conformal elimination to  $X, Y$ , and  $D := D(X, Y)$ : there exists  $Z \in \mathcal{F}$  such that  $Z_e = 0$  for some  $e \in D$  and  $Z_D \preceq X_D$ , and  $Z \setminus D = (X \circ Y) \setminus D = X \setminus D = Y \setminus D$ . We assume that  $Z$  is maximal w.r.t.  $\preceq$  with that property. Then  $Z \prec X$  and  $S := Z^0 \setminus X^0 = \underline{X} \setminus \underline{Z} \subseteq D$ . Furthermore there is no  $Z' \in \mathcal{F}$  with  $Z \prec Z' \prec X$ . By Lemma 0.7.6 is  $S$  a parallel class of  $\mathcal{F}/E^0$ , hence of  $\mathcal{F}$ , and obviously  $Z \circ (-X) = Z \circ Y = \overline{X} \in \mathcal{T}$ . ■

We consider in the following the poset formed by covectors and the conformal relation  $\preceq$ . We have seen in Section 0.1 that a sphere arrangement and the corresponding oriented matroid have the same face posets. If an artificial greatest element  $\mathbf{1}$  is added to the set of covectors then the relation  $\preceq$  defines a lattice (for an illustration see Figure 0.3):

**0.7.8 Lemma** *Let  $\mathcal{M} = (E, \mathcal{F})$  be an oriented matroid. The partially ordered set  $\hat{\mathcal{F}}(\mathcal{M}) := (\hat{\mathcal{F}}, \preceq)$  is a lattice, where  $\hat{\mathcal{F}} := \mathcal{F} \cup \{\mathbf{1}\}$  and  $\preceq$  is the conformal relation extended by  $X \preceq \mathbf{1}$  for all  $X \in \hat{\mathcal{F}}$ .*

**Proof** Let  $\mathcal{M} = (E, \mathcal{F})$  be an oriented matroid and  $(\hat{\mathcal{F}}, \preceq)$  be the partially ordered set as defined above. Consider any faces  $X, Y \in \hat{\mathcal{F}}$ . We have to show the existence of  $\sup(X, Y) \in \hat{\mathcal{F}}$  and  $\inf(X, Y) \in \hat{\mathcal{F}}$ :

- (i) There exists a smallest element  $\sup(X, Y) \in \hat{\mathcal{F}}$  such that  $X \preceq \sup(X, Y)$  and  $Y \preceq \sup(X, Y)$ : If  $X \preceq Y$  or  $Y \preceq X$  then  $\sup(X, Y) = Y$  or  $\sup(X, Y) = X$ , respectively. Otherwise  $X$  and  $Y$  are not comparable, therefore  $X, Y \in \mathcal{F} \setminus \{\mathbf{0}\}$ . If  $D(X, Y) = \emptyset$  then  $\sup(X, Y) = X \circ Y = Y \circ X \in \mathcal{F}$ , otherwise  $\sup(X, Y) = \mathbf{1}$ .
- (ii) There exists a greatest element  $\inf(X, Y) \in \hat{\mathcal{F}}$  such that  $\inf(X, Y) \preceq X$  and  $\inf(X, Y) \preceq Y$ : If  $X \preceq Y$  or  $Y \preceq X$  then  $\inf(X, Y) = X$  or  $\inf(X, Y) = Y$ , respectively. Otherwise  $X$  and  $Y$  are not comparable, therefore  $X, Y \in \mathcal{F} \setminus \{\mathbf{0}\}$ . Consider the (finite) set of lower bounds  $\{Z^1, \dots, Z^\ell\} = \{Z \in \mathcal{F} \mid Z \preceq X \text{ and } Z \preceq Y\}$ , which is non-empty as it contains  $\mathbf{0}$ . Then  $\inf(X, Y) = Z^1 \circ \dots \circ Z^\ell \in \mathcal{F}$  (note that the order of the  $Z^i$  does not affect the result of the composition). ■

**0.7.9 Definition (The Big Face Lattice)** For an oriented matroid  $\mathcal{M} = (E, \mathcal{F})$  we call the lattice  $\hat{\mathcal{F}}(\mathcal{M}) = (\hat{\mathcal{F}}, \preceq)$  defined in Lemma 0.7.8 *the face lattice of  $\mathcal{M}$*  (also called *the big face lattice of  $\mathcal{M}$* ), and  $\hat{\mathcal{F}}$  is called *the set of faces of  $\mathcal{M}$* .

We define  $\text{rank}_{\mathcal{M}}(\mathbf{1}) := \text{rank}(\mathcal{M}) + 1$ .

The following result says that the big face lattice of an oriented matroid  $\mathcal{M}$  is a graded lattice (of length  $\text{rank}(\mathcal{M}) + 1$ ); this is also called the Jordan-Dedekind chain property.

**0.7.10 Theorem (Rank Equals Height in Face Lattice [FL78, LV80])** *In the face lattice  $\hat{\mathcal{F}}(\mathcal{M})$  of an oriented matroid  $\mathcal{M} = (E, \mathcal{F})$ , the height of any  $X \in \hat{\mathcal{F}}$  is uniquely determined as it equals the rank of  $X$  in  $\mathcal{M}$ .*



**Proof** Consider  $X, Y \in \hat{\mathcal{F}}$  with the property that  $X \prec Y$  and there is no  $Z \in \hat{\mathcal{F}}$  such that  $X \prec Z \prec Y$ . We show  $\text{rank}_{\mathcal{M}}(Y) - \text{rank}_{\mathcal{M}}(X) = 1$ ; this is sufficient to prove the claim, as by definition  $\text{rank}_{\mathcal{M}}(\mathbf{0}) = \text{rank}(\mathcal{M}) - \text{rank}_{\mathcal{M}}(E) = \text{rank}(\mathcal{M}) - \text{rank}(\mathcal{M}) = 0$ . For  $Y \neq \mathbf{1}$  the claim follows from Lemma 0.7.6. If  $Y = \mathbf{1}$  then  $X$  is a tope, hence is  $X^0$  the set of loops of  $\mathcal{M}$  (see also Lemma 0.7.2) and therefore  $\text{rank}_{\mathcal{M}}(X^0) = 0$  and  $\text{rank}_{\mathcal{M}}(Y) - \text{rank}_{\mathcal{M}}(X) = (\text{rank}(\mathcal{M}) + 1) - (\text{rank}(\mathcal{M}) - 0) = 1$ . ■

**0.7.11 Corollary (Rank and Dimension of Cocircuits and Topes)** *A covector  $X \in \mathcal{F}$  is a cocircuit if and only if  $\text{rank}_{\mathcal{M}}(X) = 1$ , or, equivalently,  $\dim_{\mathcal{M}}(X) = 0$ . The set of zero supports of cocircuits is the set of hyperplanes of the underlying matroid.  $X$  is a tope if and only if  $\text{rank}_{\mathcal{M}}(X) = \text{rank}(\mathcal{M})$ , or, equivalently,  $\dim_{\mathcal{M}}(X) = \dim(\mathcal{M})$ .*

**0.7.12 Definition ( $\mathcal{F}_i$ ,  $i$ -Face,  $f_i$ )** Given an oriented matroid  $\mathcal{M} = (E, \mathcal{F})$ , we call for  $i \in \{-1, \dots, \dim(\mathcal{M})\}$  a sign vector in

$$\mathcal{F}_i := \{X \in \mathcal{F} \mid \dim_{\mathcal{M}}(X) = i\}$$

an  $i$ -face, and we set  $f_i := |\mathcal{F}_i|$  for the number of  $i$ -faces.

Obviously always  $f_{-1} = 1$ ; furthermore  $f_0 = |\mathcal{D}|$  and  $f_d = |\mathcal{T}|$ , where  $d = \dim(\mathcal{M})$ .

**0.7.13 Theorem (Diamond Property [FL78, LV80])** *Let  $\mathcal{M} = (E, \mathcal{F})$  be an oriented matroid and  $X, Y \in \hat{\mathcal{F}}$  such that  $X \preceq Y$  and  $\text{rank}_{\mathcal{M}}(Y) - \text{rank}_{\mathcal{M}}(X) = 2$ . Then there exist exactly two covectors  $Z^1, Z^2 \in \mathcal{F}$  with the property  $X \prec Z^i \prec Y$  for  $i \in \{1, 2\}$ .*

The diamond property is called like that because of the diamond-like shape formed by  $X, Z^1, Z^2, Y$  in the face lattice (see Figure 0.4).

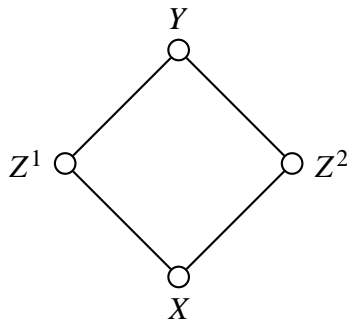

Figure 0.4: Diamond property

**Proof of Theorem 0.7.13** Consider  $X, Y \in \hat{\mathcal{F}}$  such that  $X \preceq Y$  and  $\text{rank}_{\mathcal{M}}(Y) - \text{rank}_{\mathcal{M}}(X) = 2$ . By Theorem 0.7.10 there exists  $Z = Z^1 \in \hat{\mathcal{F}}$  such that  $X \prec Z \prec Y$ , which is a maximal chain. Obviously  $X, Z \in \mathcal{F}$ , and by Lemma 0.7.6 is  $S := X^0 \setminus Z^0$  a parallel class of  $\mathcal{F}/Z^0$ .

If  $Y = \mathbf{1}$  then  $Z$  is a tope and the question is how many topes  $Z^i$  satisfy  $X \prec Z^i$ ; since  $S$  is a parallel class of  $\mathcal{F}/Z^0$  and hence of  $\mathcal{F}$  as  $Z^0$  is the set of loops of  $\mathcal{M}$ ,  $Z^1 := Z$  and  $Z^2 := X \circ (-Z) \in \mathcal{F}$  are the only two topes with this property (note that (F1) and (F2) are needed for  $Z^2 \in \mathcal{F}$ ).

If  $Y \neq \mathbf{1}$  then (by Lemma 0.7.6)  $Z^0 \setminus Y^0$  is a parallel class of  $\mathcal{F}/Y^0$ . By conformal

elimination (F3<sup>c</sup>) applied to  $Y$ ,  $-Z$ , and  $S = X^0 \setminus Z^0 \subseteq D(Y, -Z) = \underline{Z}$  there exist  $e \in S$  and  $\tilde{Z} \in \mathcal{F}$  such that  $\tilde{Z}_e = 0$  and  $\tilde{Z}_S \preceq Y_S$  and  $\tilde{Z}_f = (Y \circ (-Z))_f$  for all  $f \in E \setminus D(Y, -Z) = Z^0$ . Replacing  $\tilde{Z}$  by  $X \circ \tilde{Z}$  does not affect these properties since  $\underline{X} = D(Y, -Z) \setminus S$ . Then  $X \prec \tilde{Z} \prec Y$  (remark that  $Z^0 \setminus Y^0 \subseteq \tilde{Z}$ ) and  $Z \neq \tilde{Z}$ . Since  $Y^0 \subseteq \tilde{Z}^0$  and  $e \in \tilde{Z}^0 \cap S$ , where  $S$  is a parallel class of  $\mathcal{F}/Y^0$ , Lemma 0.7.5 implies  $\tilde{Z}_S = \mathbf{0}$ , hence  $X^0 \subseteq Z^0 \cup \tilde{Z}^0$ . Assume that  $X \prec W \prec Y$  for some  $W \in \mathcal{F}$ . Then there exists  $e' \in X^0 \setminus Y^0$  such that  $W_{e'} = 0$ , hence  $e' \in (Z^0 \cup \tilde{Z}^0) \setminus Y^0$ . Since  $Z^0 \setminus Y^0$  and  $\tilde{Z}^0 \setminus Y^0$  are parallel classes of  $\mathcal{F}/Y^0$  and  $Y^0 \subseteq W^0$ , Lemma 0.7.5 implies  $Z^0 \subseteq W^0$  or  $\tilde{Z}^0 \subseteq W^0$ , hence  $Z = W$  or  $\tilde{Z} = W$ . ■

It is not difficult to see the following:

**0.7.14 Lemma (Oriented Matroids of Rank 1 and 0)** *The face lattice of an oriented matroid  $(E, \mathcal{F})$  of rank 1 has exactly the form of a diamond, where  $X = \mathbf{0}$ ,  $Z^1 = -Z^2$ , and  $Y = \mathbf{1}$ . The face lattice of an oriented matroid of rank 0 only consists of  $\mathbf{0} \prec \mathbf{1}$ .*

## 0.8 Oriented Matroid Programming

Oriented matroid programming is the abstraction of linear programming in the setting of oriented matroids. The original work of Bland [Bla77] discusses oriented matroid programming in terms of dual pairs of oriented matroids, the primal presentation which we give in the following is due to Fukuda [Fuk82]. Our introduction is very short, for more details see Chapter 10 in [BLVS<sup>+</sup>99] and the references cited in this section. We will need oriented matroid programming in the proof of Theorem 1.3.1.

Remember that for a sign vector  $X \subseteq \{-, +, 0\}^E$  we write  $X \geq 0$  if  $X_e \in \{+, 0\}$  for all  $e \in E$ , and similarly  $X \leq 0$  if  $-X \geq 0$ . The same notation is also used for single signs (e.g.,  $X_e \geq 0$ ).

**0.8.1 Definition (Oriented Matroid Program)** Let  $\mathcal{M} = (E, \mathcal{F})$  be an oriented matroid and  $f, g \in E$  two distinct elements. Let  $X, Z$  be sign vectors on  $E$ .

- $X$  is called *feasible* if  $X \in \mathcal{F}$  and  $X \setminus f \geq 0$  and  $X_g = +$ .
- $Z$  is called *a direction* if  $Z \in \mathcal{F}$  and  $Z_g = 0$ .
- $Z$  is called *an unbounded direction* if  $Z$  is a direction,  $Z \setminus f \geq 0$ , and  $Z_f = +$ .
- For a feasible  $X$ , we call  $Z$  *an augmenting direction for  $X$*  if  $Z$  is a direction with  $(X \circ Z) \setminus f \geq 0$  and  $Z_f = +$ .
- $X$  is called *optimal* if  $X$  is feasible and there is no augmenting direction for  $X$ .

The *oriented matroid program*  $\text{OMP}(\mathcal{M}, g, f)$  is the problem to find an optimal sign vector  $X$ .

**0.8.2 Definition** Let  $\mathcal{M} = (E, \mathcal{F})$  be an oriented matroid and  $f, g \in E, f \neq g$ . Consider  $\mathcal{P} := \text{OMP}(\mathcal{M}, g, f)$ .  $\mathcal{P}$  is called *feasible* if there exists a feasible  $X$  for  $\mathcal{P}$ , *unbounded* if  $\mathcal{P}$  is feasible and there exists an unbounded direction for  $\mathcal{P}$ , and *optimal* if there exists an optimal  $X$  for  $\mathcal{P}$ . If  $\mathcal{P}$  is not feasible then  $\mathcal{P}$  is called *infeasible*.

**0.8.3 Lemma (OMP Induction)** Let  $\mathcal{M} = (E, \mathcal{F})$  be an oriented matroid and  $f, g \in E, f \neq g$ . Consider  $\mathcal{P} := \text{OMP}(\mathcal{M}, g, f)$  and  $e \in E \setminus \{f, g\}$ , and define the oriented matroid programs  $\mathcal{P} \setminus e := \text{OMP}(\mathcal{M} \setminus e, g, f)$  and  $\mathcal{P}/e := \text{OMP}(\mathcal{M}/e, g, f)$ . Then:

- (i) If  $\mathcal{P} \setminus e$  optimal and  $\mathcal{P}/e$  optimal then  $\mathcal{P}$  optimal.
- (ii) If  $\mathcal{P} \setminus e$  optimal and  $\mathcal{P}/e$  infeasible then  $\mathcal{P}$  optimal or infeasible.
- (iii) If  $\mathcal{P} \setminus e$  unbounded and  $\mathcal{P}/e$  optimal then  $\mathcal{P}$  unbounded or optimal.
- (iv) If  $\mathcal{P} \setminus e$  unbounded and  $\mathcal{P}/e$  infeasible then  $\mathcal{P}$  unbounded or infeasible.

**Proof** (i) Let  $X \in \mathcal{F}$  be such that  $X \setminus e$  is an optimal solution of  $\mathcal{P} \setminus e$ , and let  $\tilde{X} \in \mathcal{F}$  be such that  $\tilde{X} \setminus e$  is an optimal solution of  $\mathcal{P}/e$ , hence  $\tilde{X}_e = 0$ . Assume that  $X$  is not an optimal solution of  $\mathcal{P}$ . If  $X_e \geq 0$  then  $X$  is feasible, so there exists an augmenting direction  $Z \in \mathcal{F}$  for  $X$ , but then is  $Z \setminus e$  an augmenting direction for  $X \setminus e$ , in contradiction to the optimality of  $X \setminus e$  for  $\mathcal{P} \setminus e$ . Hence  $X_e = -$ . Apply covector elimination (F3) to  $-X, \tilde{X}$ , and  $g$ . There exists  $Z \in \mathcal{F}$  such that  $Z_g = 0$  and  $Z_h = ((-X) \circ \tilde{X})_h$  for every  $h \in E \setminus D(-X, \tilde{X})$ , especially  $Z_{X^0} \geq 0, Z_{\tilde{X}^0} \leq 0$ , and  $Z_e = +$ . The optimality of  $X \setminus e$  implies that  $Z_f \leq 0$ . Assume that  $\tilde{X}$  is not an optimal solution of  $\mathcal{P}$ . Then there exists  $\tilde{Z} \in \mathcal{F}$  such that  $\tilde{Z}_g = 0, \tilde{Z}_f = +, \tilde{Z}_{\tilde{X}^0} \geq 0$ , and  $\tilde{Z}_e = +$  (because of  $\tilde{X}_e = 0$  and the optimality of  $\tilde{X}$  for  $\mathcal{P}/e$ ). Apply covector elimination (F3) to  $-Z, \tilde{Z}$ , and  $e$ . There exists  $\hat{Z} \in \mathcal{F}$  such that  $\hat{Z}_e = 0, \hat{Z}_g = 0, \hat{Z}_{\tilde{X}^0} \geq 0$ , and  $\hat{Z}_f = +$ , in contradiction to the optimality of  $\tilde{X} \setminus e$  for  $\mathcal{P}/e$ .

(ii) Let  $X \in \mathcal{F}$  be such that  $X \setminus e$  is an optimal solution of  $\mathcal{P} \setminus e$  but not of  $\mathcal{P}$ , hence  $X_e = -$  as in (i). Assume that  $\mathcal{P}/e$  is infeasible, but not  $\mathcal{P}$ , i.e., there exists  $\tilde{X} \in \mathcal{F}$  such that  $\tilde{X}_g = +, \tilde{X} \setminus f \geq 0$ , and  $\tilde{X}_e = +$ . Apply covector elimination (F3) to  $X, \tilde{X}$ , and  $e$ . There exists  $Z \in \mathcal{F}$  such that  $Z_e = 0, Z \setminus f \geq 0, Z_g = +$ . This implies that  $\mathcal{P}/e$  is feasible, a contradiction.

(iii) Let  $Z \in \mathcal{F}$  be such that  $Z_g = 0, Z_f = +$ , and  $Z \setminus e \geq 0$ . Let  $X \in \mathcal{F}$  be such that  $X \setminus e$  is an optimal solution of  $\mathcal{P}/e$ , so  $X_g = +, X \setminus f \geq 0$ , and  $X_e = 0$ . Assume that  $\mathcal{P}$  is not unbounded and not optimal. Then  $Z_e = -$ , and there exists  $Z' \in \mathcal{F}$  such that  $Z'_f = +, Z'_g = 0$ , and  $Z'_{X^0} \geq 0$ . Furthermore, the optimality of  $\mathcal{P}/e$  implies  $Z'_e \neq 0$ , hence  $Z'_e = +$ . Apply covector elimination (F3) to  $Z, Z'$ , and  $e$ . There exists  $\tilde{Z} \in \mathcal{F}$  such that  $\tilde{Z}_e = 0, \tilde{Z}_g = 0, \tilde{Z}_f = +$ , and  $\tilde{Z}_{X^0} \geq 0$ , a contradiction to the optimality of  $X$  for  $\mathcal{P}/e$ .

(iv) Let  $Z \in \mathcal{F}$  be such that  $Z_g = 0, Z_f = +$ , and  $Z \setminus e \geq 0$ . Assume that  $\mathcal{P}$  is not unbounded, hence  $Z_e = -$ . If  $\mathcal{P}$  is feasible then there exists  $X \in \mathcal{F}$  such that  $X_g = +$  and  $X \setminus f \geq 0$ . As  $\mathcal{P}/e$  is infeasible,  $X_e = +$ . Apply covector elimination (F3) to  $Z, X$ , and  $e$ . There exists  $\tilde{Z}$  such that  $\tilde{Z}_e = 0, \tilde{Z}_g = +$ , and  $\tilde{Z} \setminus f \geq 0$ , a contradiction to the assumption that  $\mathcal{P}/e$  is infeasible. ■

The following theorem is closely related to the duality theorem of oriented matroid programming [Law75, Bla77]. The primal presentation as given here follows [Fuk82].

**0.8.4 Theorem (Fundamental Theorem of OMP)** *Every oriented matroid program  $\mathcal{P} = (\mathcal{M}, g, f)$  is exactly one of optimal, unbounded, or infeasible.*

**Proof** The proof is by induction on  $|E|$  and mainly based on the OMP induction (see Lemma 0.8.3). For  $|E| = 2$  is  $E = \{f, g\}$ . Assume that  $\mathcal{P}$  is feasible but not unbounded: there exists  $X \in \mathcal{F}$  such that  $X_g = +$ , and there is no  $Z \in \mathcal{F}$  such that  $Z_g = 0$  and  $Z_f = +$ . Therefore,  $X$  is an optimal solution for  $\mathcal{P}$ .

Assume  $|E| > 2$ . Choose any  $e \in E \setminus \{f, g\}$ . By induction we assume that  $\mathcal{P} \setminus e$  and  $\mathcal{P}/e$  both are one of optimal, unbounded, or infeasible. Observe that if  $\mathcal{P} \setminus e$  infeasible then also  $\mathcal{P}$  and  $\mathcal{P}/e$ . Furthermore, if  $\mathcal{P}/e$  unbounded then also  $\mathcal{P}$  and  $\mathcal{P} \setminus e$ . Together with the inductive result of Lemma 0.8.3 this implies in all cases that  $\mathcal{P}$  is one of optimal, unbounded, or infeasible:

		$\mathcal{P}/e$		
		optimal	unbounded	infeasible
$\mathcal{P} \setminus e$	optimal	optimal Lemma 0.8.3 (i)	(not possible)	optimal or infeasible Lemma 0.8.3 (ii)
	unbounded	unbounded or optimal Lemma 0.8.3 (iii)	unbounded	unbounded or infeasible Lemma 0.8.3 (iv)
	infeasible	(not possible)	(not possible)	infeasible

■

## 0.9 Basis Orientations and Chirotopes

This section introduces basis orientations and chirotopes. We will use chirotopes for a compact encoding of oriented matroids in Chapter 6. Chirotopes can be characterized by so-called Grassmann-Plücker relations (see Definition 3.5.3 in [BLVS<sup>+</sup>99]) which gives again another equivalent set of axioms of oriented matroids (we do not discuss this).

**0.9.1 Definition (Ordered Sets)** Let  $S$  be a finite set. We write  $(S)$  for some fixed (linear) order of the elements in  $S$ . If  $\pi$  is a permutation on  $S$  then  $\pi(S)$  denotes the ordered set obtained from  $(S)$  by reordering the elements according to  $\pi$ . For elements  $e \in S$ ,  $f \notin S$  we denote by  $(S : e \rightarrow f)$  the ordered set obtained from  $(S)$  when  $e$  is replaced by  $f$  at the same position, keeping the relative ordering of the other elements. For a set  $\mathcal{S}$  of finite sets define  $(\mathcal{S}) := \{(S) \mid S \in \mathcal{S}\}$  to be the set of all ordered sets obtained by fixing an order (in every possible way) for all  $S \in \mathcal{S}$ .

A basis orientation is the sign of an abstract determinant of a basis: Consider a matrix  $A$  of full column rank and a subset  $B$  of the column index set which corresponds to a basis of  $A$ . The determinant of the corresponding submatrix of  $A$  is non-zero, i.e., has sign  $-$  or  $+$ . The determinant is defined for a specific ordering of the basis vectors, and a permutation  $\pi$  of the columns in  $B$  will multiply the sign of the determinant with  $\text{sign}(\pi)$ , which is the sign of the permutation defined in the usual way (the sign of identity is  $+$ , and by any transposition of two elements the sign is reversed). In this sense, the sign of the determinant is an alternating function. For the following we use the arithmetic of signs which is defined by  $+\cdot+ = -\cdot- = +$  and  $+\cdot- = -\cdot+ = -$ .

**0.9.2 Lemma** *Let  $\mathcal{M} = (E, \mathcal{F})$  be an oriented matroid and  $\mathcal{D}$  its set of cocircuits. For every basis  $B \in \mathcal{B}$  and every  $e \in B$  there exist exactly two cocircuits  $X, -X \in \mathcal{D}$  such that  $B \setminus e \subseteq X^0$ ; then  $X_e \neq 0$ .*

**Proof** Use the definition of bases, and cocircuit axiom (C2). ■

**0.9.3 Definition (Fundamental Cocircuit)** Let  $\mathcal{M} = (E, \mathcal{F})$  be an oriented matroid and  $\mathcal{D}$  its set of cocircuits. For a basis  $B \in \mathcal{B}$  and  $e \in B$  we call the cocircuit  $X \in \mathcal{D}$  determined by  $B \setminus e \subseteq X^0$  and  $X_e = +$  the *fundamental cocircuit of  $\mathcal{M}$  w.r.t.  $B$  and  $e$*  and denote it by  $X(B, e)$ .

**0.9.4 Definition (Basis Orientation of an Oriented Matroid)** Let  $\mathcal{M} = (E, \mathcal{F})$  be an oriented matroid and  $\mathcal{D}$  its set of cocircuits. Let  $\mathcal{B}$  be the set of bases of the underlying matroid  $\underline{\mathcal{M}}$ . A map  $\chi : (\mathcal{B}) \rightarrow \{-, +\}$  is called a *basis orientation of  $\mathcal{M}$*  if

- (B0)  $\chi$  is alternating, i.e.,  $\chi(B) = \text{sign}(\pi) \cdot \chi(\pi(B))$  for all  $(B) \in (\mathcal{B})$  and all permutations  $\pi$  of  $B$ ,
- (B1) for all  $(B) \in (\mathcal{B})$ ,  $e \in B$ ,  $f \notin B$  such that  $B \setminus e \cup f \in \mathcal{B}$ ,  
 $\chi(B : e \rightarrow f) = X_e \cdot X_f \cdot \chi(B)$ , where  $X = X(B, e) \in \mathcal{D}$  is the fundamental cocircuit w.r.t.  $B$  and  $e$  (or, equivalently, its negative).

**0.9.5 Theorem (Las Vergnas [LV75, LV78a])** *Every oriented matroid has exactly two basis orientations  $\chi$  and  $-\chi$ .*

**Proof** The proof follows essentially Lawrence [Law82], but does not use any duality arguments; instead we use cocircuit elimination. The proof is by induction on  $|E|$ . The case  $|E| = r$  is trivial as there is only one basis. Assume  $|E| > r$ . Let  $\hat{B} \in \mathcal{B}$  be a basis of  $\mathcal{M}$  and set  $\chi(\hat{B}) := +$ . We have to prove that this determines  $\chi$  in a unique and consistent way. Choose any  $a \in E \setminus \hat{B}$  and consider  $\mathcal{M} \setminus a$ . Since  $a \notin \hat{B}$ ,  $a$  is not a coloop of  $\mathcal{M}$ , and by Corollary 0.4.9 (i)  $\text{rank}(\mathcal{M} \setminus a) = \text{rank}(\mathcal{M})$ . Furthermore, the set of bases of  $\mathcal{M} \setminus a$  is the set of those bases  $B$  of  $\mathcal{M}$  for which  $a \notin B$ . By induction, there exists a unique basis orientation  $\chi'$  for  $\mathcal{M} \setminus a$  with  $\chi'(\hat{B}) = +$ . We set  $\chi(B) := \chi'(B)$  for all ordered bases  $(B)$  of  $E$  which do not contain  $a$ . Let  $(B)$  be an ordered basis of  $\mathcal{M}$  that contains  $a$  and  $\tilde{X} := X(B, a)$  the fundamental cocircuit w.r.t.  $B$  and  $a$ . Set  $\chi(B) := \tilde{X}_a \cdot \tilde{X}_e \cdot \chi(B : a \rightarrow e)$  for some  $e \in \tilde{X} \setminus a$  (note that  $\tilde{X} \setminus a \neq \emptyset$  since  $a$  is not a coloop,  $B \setminus a \cup e$  is a basis, and the definition of  $\chi(B)$  is independent from the choice

of  $e$  since  $\chi$  satisfies (B1) for all ordered bases of  $E$  which do not contain  $a$ . By this,  $\chi$  is defined for all ordered bases of  $E$ , and  $\chi$  satisfies (B0) by induction and by the way of the definition for the ordered sets which contain  $a$ .

It remains to prove (B1) for  $e, f \in E$ ,  $e \neq f$ . If  $a = e$  or  $a = f$  then (B1) follows from the definition of  $\chi$ . Assume for the following  $e \neq a$  and  $f \neq a$ . Consider a basis  $B \in \mathcal{B}$  such that  $a \in B$ ,  $e \in B$ ,  $f \notin B$ , and  $B \setminus e \cup f \in \mathcal{B}$ . We have to show that  $\chi(B : e \rightarrow f) = X_e \cdot X_f \cdot \chi(B)$ , where  $X = X(B, e)$ .

In the *first case*  $f \notin \text{span}_{\mathcal{M}}(B \setminus a)$ . Then is  $B \setminus a \cup f$  a basis, and by definition

$$\begin{aligned}\chi(B) &= X_a^{af} \cdot X_f^{af} \cdot \chi(B : a \rightarrow f) \text{ for } X^{af} = X(B, a), \\ \chi(B : a \rightarrow f : e \rightarrow a) &= X_a^{ae} \cdot X_e^{ae} \cdot \chi(B : a \rightarrow f) \text{ for } X^{ae} = X(B \setminus e \cup f, a).\end{aligned}$$

By cocircuit elimination (C3) applied to  $X^{af}$ ,  $-X^{ae}$ , and  $a$  there exists  $X^{ef} \in \mathcal{D}$  such that  $X_a^{ef} = 0$  and  $X_h^{ef} \in \{X_h^{af}, -X_h^{ae}, 0\}$  for all  $h \in E$ , hence  $B \setminus e \subseteq X^{ef}$  and therefore  $X^{ef} = \pm X(B, e)$  and  $X_e^{ef} = -X_e^{ae}$  and  $X_f^{ef} = X_f^{af}$ . In combination this leads to  $\chi(B : e \rightarrow f) = -\chi(B : a \rightarrow f : e \rightarrow a) = X_e^{ef} \cdot X_f^{ef} \cdot \chi(B)$ , which proves the claim in the first case.

In the *second case*  $f \in \text{span}_{\mathcal{M}}(B \setminus a)$ . Set  $Y := X(B, a) \in \mathcal{D}$ , then  $Y_f = 0$ . Choose any  $g \in \underline{Y} \setminus a$ , then  $B \setminus a \cup g \in \mathcal{B}$  and  $B \setminus \{a, e\} \cup \{f, g\} \in \mathcal{B}$ . Similar to the first case, we compose the replacement as  $(B : e \rightarrow f) = (B : a \rightarrow g : e \rightarrow f : g \rightarrow a)$  and use again cocircuit elimination (once on  $a$  and once on  $g$ ) to prove the claim. We leave the details to the reader. ■

**0.9.6 Definition (Chirotope)** Let  $\mathcal{M} = (E, \mathcal{F})$  be an oriented matroid. Set  $n := |E|$  and  $r := \text{rank}(\mathcal{M})$ . We call  $\{\chi, -\chi\}$  the *chirotope* of  $\mathcal{M}$  if  $\chi$  is a map defined on all ordered subsets ( $S$ ) of  $E$  with cardinality  $r$  such that  $\chi$ , restricted to the set of ordered bases of  $\mathcal{M}$ , is a basis orientation of  $\mathcal{M}$  and  $\chi(S) = 0$  if  $S$  is not a basis of  $\mathcal{M}$ .

**0.9.7 Proposition** Let  $\mathcal{M} = (E, \mathcal{F})$  be an oriented matroid of rank  $r$ . The chirotope of  $\mathcal{M}$  (together with  $E$  and  $r$ ) determines  $\mathcal{M}$ .

**Proof** Let  $\chi$  be one of the two maps in the chirotope of  $\mathcal{M}$ . The set of bases  $\mathcal{B}$  of  $\mathcal{M}$  is determined as the set of  $r$ -subsets  $B$  of  $E$  for which  $\chi(B) \neq 0$ . A sign vector  $X \in \{-, +, 0\}^E$  is a cocircuit of  $\mathcal{M}$  if and only if there exists a basis  $B \in \mathcal{B}$  and an element  $e \in B$  such that  $(B \setminus e) \subseteq X^0$ ,  $X_e \neq 0$ , and  $X_f = X_e \cdot \chi(B) \cdot \chi(B : e \rightarrow f)$  for all  $f \notin B$ . ■

For the rest of this section we consider the chirotope of the dual of an oriented matroid. Let  $\mathcal{M} = (E, \mathcal{F})$  be an oriented matroid and  $B$  a basis of  $\mathcal{M}$ . By Proposition 0.5.11,  $N := E \setminus B$  is a basis of the dual  $\mathcal{M}^*$ . Let  $e \in B$  and  $f \in N$ , and consider the fundamental cocircuit  $X = X(B, e) \in \mathcal{F}$  and the so-called *fundamental circuit*  $Y = Y(N, f) \in \mathcal{F}^*$  which is characterized by  $N \setminus f \subseteq Y^0$  and  $Y_f = +$  (consider Lemma 0.9.2 for  $\mathcal{M}^*$ ). By definition,  $X * Y$ , furthermore  $\underline{X} \cap \underline{Y} \subseteq \{e, f\}$  and  $X_e = Y_f = +$ , hence  $X_f = -Y_e$ . Let  $\chi$  and  $\chi^*$  be basis orientations of  $\mathcal{M}$  and  $\mathcal{M}^*$ , respectively. Then,

$$\chi^*(N : f \rightarrow e) = Y_f \cdot Y_e \cdot \chi^*(N) = -X_e \cdot X_f \cdot \chi^*(N),$$

which is the dual form of (B1). This leads to the following simple rule for the computation of the chirotope of the dual from the primal:

**0.9.8 Lemma** *Let  $\mathcal{M} = (E, \mathcal{F})$  be an oriented matroid and  $\chi$  one of the two maps in the chirotope of  $\mathcal{M}$ . Consider a fixed order of  $E$ . Then, one of the two maps in the chirotope of  $\mathcal{M}^*$  is determined by*

$$\chi^*(N) = \text{sign}(\pi(B, N)) \cdot \chi(B),$$

where  $(B) = (b_1, \dots, b_r)$  and  $(N) = (b_{r+1}, \dots, b_n)$  are ordered bases of  $\underline{\mathcal{M}}$  and  $\underline{\mathcal{M}^*}$ , respectively, where  $N = E \setminus B$ , and  $\pi(B, N)$  is the permutation to sort  $(b_1, \dots, b_n)$  according to the fixed order of  $E$ .

**Proof** Note that  $\chi^*(N) \neq 0$  if and only if  $N$  is a basis of  $\underline{\mathcal{M}^*}$ , which is the case if and only if  $B = E \setminus N$  is a basis of  $\underline{\mathcal{M}}$  (see Proposition 0.5.11), hence if and only if  $\chi(B) \neq 0$  for any order of  $B$ .

Let  $\chi^*$  be such that  $\chi^*(N) = \text{sign}(\pi(B, N)) \cdot \chi(B)$  for all ordered bases  $(B)$  and  $(N)$  of  $\underline{\mathcal{M}}$  and  $\underline{\mathcal{M}^*}$ , respectively, where  $N = E \setminus B$ . We have to show that  $\chi^*$ , restricted to the set of ordered bases of  $\mathcal{M}^*$ , is a basis orientation of  $\mathcal{M}^*$ . Let  $(B) = (b_1, \dots, b_r)$  and  $(N) = (b_{r+1}, \dots, b_n)$  be ordered bases of  $\underline{\mathcal{M}}$  and  $\underline{\mathcal{M}^*}$ , respectively, such that  $N = E \setminus B$ . Consider  $e \in B$  and  $f \in N$ . By assumption on  $\chi^*$  and property (B1) of  $\chi$ ,

$$\begin{aligned} \chi^*(N : f \rightarrow e) &= -\text{sign}(\pi(B, N)) \cdot \chi(B : e \rightarrow f) \\ &= -\text{sign}(\pi(B, N)) \cdot X_e \cdot X_f \cdot \chi(B) \\ &= -X_e \cdot X_f \cdot \chi^*(N), \end{aligned}$$

where  $X = X(B, e)$ . This is a necessary condition on  $\chi^*$  (see above), and it determines  $\chi^*$  up to negative, which implies the claim.  $\blacksquare$







**Reconstruction**



# Chapter 1

## Topes and Tope Graphs

### 1.1 Introduction and Problem Statements

Chapter 1 investigates topes and tope graphs of oriented matroids and their relation to covectors and the big face lattice of oriented matroids. The two main problems considered in this chapter are the *characterization problem* and the *reconstruction problem* of tope graphs. Partially we review known results from [FH93] and [FST91]. The main extensions of these results are the separability of uncut topes (see Theorem 1.3.1) and the reconstruction algorithms of faces and topes from cocircuits.

We first define some basic notions w.r.t. graphs, after this we introduce tope graphs, address the problems discussed in this chapter, and give an overview of Chapter 1.

A *graph*  $G = (V(G), E(G))$  is a pair of a finite set of *vertices*  $V(G)$  and a set of *edges*  $E(G)$  that are represented as unordered pairs of vertices, i.e., all edges are undirected. For a connected graph  $G$  we will denote by  $d_G(v, w)$  the (combinatorial) distance between two vertices  $v, w \in V(G)$  (i.e., the minimal number of edges in a path connecting  $v$  and  $w$ ) and by  $\text{diam}(G)$  the diameter of  $G$  (i.e., the maximal distance  $d_G(v, w)$  in  $G$ ).

Two graphs  $G, G'$  are called *isomorphic* if there exists a bijection  $\phi : V(G) \rightarrow V(G')$  such that  $\{\phi(v), \phi(w)\} \in E(G')$  if and only if  $\{v, w\} \in E(G)$ . Then we call  $\phi$  a *graph isomorphism*. If  $G = G'$ , then we call  $\phi$  a *graph automorphism*; the set of all automorphisms is denoted by  $\text{Aut}(G)$ . If the vertices of  $G$  are not labeled, then we usually identify graphs that are isomorphic, e.g., we say that  $G$  and  $G'$  are *equal* if they are isomorphic.

The first class of graphs, which we discuss in this chapter, are the tope graphs of oriented matroids. In a pseudosphere arrangement (see Section 0.1) topes correspond to regions of maximal dimension  $d$ , and two topes are adjacent if they have a common  $(d - 1)$ -face. The following definition of tope graphs also applies to sets of sign vectors which are not tope sets of oriented matroids, which will be important for further investigations:

**1.1.1 Definition (Tope Graph)** Let  $(E, \mathcal{T})$  be a pair of a finite set  $E$  and  $\mathcal{T} \subseteq \{-, +, 0\}^E$

such that all sign vectors in  $\mathcal{T}$  have the same support. The *tope graph* of  $(E, \mathcal{T})$  is a graph  $G$  with exactly  $|\mathcal{T}|$  vertices that can be associated by a bijection  $\mathcal{L} : V(G) \rightarrow \mathcal{T}$  such that  $\{x, y\}$  is an edge in  $E(G)$  if and only if the set of separating elements  $D(\mathcal{L}(x), \mathcal{L}(y))$  is a parallel class of  $\mathcal{T}$ . If  $\mathcal{T}$  is the tope set of an oriented matroid  $\mathcal{M}$  we also call  $G$  the *tope graph* of  $\mathcal{M}$ .

We will call a bijection  $\mathcal{L} : V(G) \rightarrow \mathcal{T}$  like in Definition 1.1.1 an *associating bijection*.

An example of an oriented matroid (illustrated by a pseudosphere arrangement) and its tope graph is given in Figure 1.1.

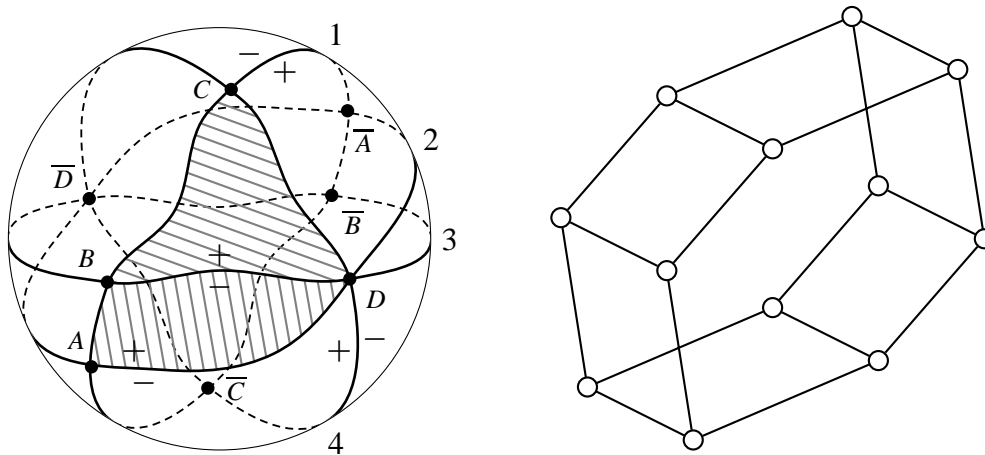

Figure 1.1: Adjacent regions in pseudosphere arrangement and tope graph

For oriented matroids  $(E, \mathcal{F})$  the above definition of a tope graph falls together with the explanation given before: the parallel classes of the tope set  $\mathcal{T}$  are the same as the parallel classes of  $\mathcal{F}$ , and for  $X, Y \in \mathcal{T}$  there exists a  $(d-1)$ -face  $Z \in \mathcal{F}$  such that  $Z < X$  and  $Z < Y$  if and only if  $Z$  is of the form  $Z \setminus D := X \setminus D = Y \setminus D$  and  $Z_D = \mathbf{0}$  for  $D = D(X, Y)$  being a parallel class of  $\mathcal{T}$ . This can be proved by covector elimination and observing Lemma 0.7.6 (for more a more general result which includes this case see Lemma 1.5.6). Hence, the tope graph of an oriented matroid  $(E, \mathcal{F})$  with set of topes  $\mathcal{T}$  is a graph  $G$  with exactly  $f_d = |\mathcal{T}|$  vertices that can be associated by a bijection  $\mathcal{L} : V(G) \rightarrow \mathcal{T}$  to the elements of  $\mathcal{T}$  such that  $\{x, y\}$  is an edge in  $E(G)$  if and only if  $\mathcal{L}(x)$  and  $\mathcal{L}(y)$  have a common lower neighbor in the face lattice ( $f_i$  denotes the number of faces of dimension  $i$ ). There is a one-to-one correspondence of  $(d-1)$ -dimensional faces and the edges in  $G$ , hence  $f_{d-1} = |E(G)|$ .

We have introduced relabeling, reorientation, and isomorphism of oriented matroids in Section 0.1. We define these notions in a more formal way again, by this also extending them to arbitrary sets of sign vectors. Remember the definition of loops and parallel elements in Definition 0.7.4.

**1.1.2 Definition (Relabeling, Reorientation, Isomorphism)** Let  $\mathcal{F}$  be a set of sign vectors on a finite ground set  $E$ . A *relabeling* of  $\mathcal{F}$  is a set of sign vectors  $\mathcal{F}'$  on a finite ground set  $E'$  such that there is a bijection  $\phi : \mathcal{F} \rightarrow \mathcal{F}'$  and a bijection  $\psi$  between the parallel classes of non-loop elements of  $\mathcal{F}$  and  $\mathcal{F}'$  such that  $X_e = \phi(X)_{e'}$  for all  $X \in \mathcal{F}$  and all  $e \in E, e' \in E'$  where  $e, e'$  are not loops of  $\mathcal{F}$  and  $\mathcal{F}'$ , respectively, and the parallel classes of  $e$  and  $e'$  are associated by  $\psi$ . A *reorientation* of  $\mathcal{F}$  is a set of sign vectors of the form  $\{\overline{S}X \mid X \in \mathcal{F}\}$  for some  $S \subseteq E$ , where  $\overline{S}X$  is the sign vector obtained from  $X$  by reversing the signs of all elements in  $S$ . We also call the map which transforms  $\mathcal{F}$  into a relabeling (or reorientation) a relabeling (or reorientation, respectively). A set of sign vectors  $\mathcal{F}'$  is called *isomorphic* to  $\mathcal{F}$  if  $\mathcal{F}'$  can be obtained from  $\mathcal{F}$  by relabeling (first) and reorientation. An *isomorphism* of  $\mathcal{F}$  is a map which transforms  $\mathcal{F}$  into a set which is isomorphic to  $\mathcal{F}$ . Reorientation, relabeling, and isomorphism define equivalence relations for sets of sign vectors. For a pair  $\mathcal{M} = (E, \mathcal{F})$  of a finite ground set  $E$  and a set of sign vectors on  $E$  these relations define its *relabeling class*  $\text{LC}(\mathcal{M})$ , *reorientation class*  $\text{OC}(\mathcal{M})$ , and *isomorphism class*  $\text{IC}(\mathcal{M})$ .

Relabeling and hence isomorphism allows the introduction and deletion of parallel elements and loops. If all loops and redundant parallel elements are deleted, one obtains an isomorphic set of sign vectors without loops such that all parallel classes contain only one element:

**1.1.3 Definition (Simple, Simplification)** Let  $\mathcal{F}$  be a set of sign vectors on a finite ground set  $E$ .  $\mathcal{F}$  is called *simple* if there are no loops and no parallel elements  $e \neq f$ . An oriented matroid  $(E, \mathcal{F})$  is called *simple* if  $\mathcal{F}$  is simple. A *simplification* of  $\mathcal{F}$  is a simple set of sign vectors which is isomorphic to  $\mathcal{F}$ .

By the definition of tope graphs, it follows:

**1.1.4 Lemma** *The tope graph of a set  $\mathcal{T}$  is equal to the tope graph of any simplification of  $\mathcal{T}$ . More general, the tope graphs of any isomorphic sets of sign vectors are equal.*

The above lemma states that the discussion of tope graphs may be restricted to simple sets  $\mathcal{T}$ ; this will not affect the generality of the results.

The present chapter mainly concerns the following two problems:

**Characterization Problem:** *Given a graph  $G$ ,  
decide whether  $G$  is the tope graph of some oriented matroid.*

**Reconstruction Problem:** *Given a tope graph  $G$  of some oriented matroid,  
find an oriented matroid  $\mathcal{M}$  such that  $G$  is the tope graph of  $\mathcal{M}$ .*

Our investigations concern algorithmic solutions and their complexities. For our complexity analyses we assume that every elementary operation (such as an addition or comparison of single elements) can be computed in constant time.

Whereas the reconstruction problem can be solved in polynomial time by a simple algorithm (see Section 1.4), the answer to the characterization problem is not that easy. In terms of graphs, there is no polynomial characterization of tope graphs of oriented matroids (unless rank is at most 3, see [FH93]), however, there exist algorithms which solve the characterization problem by the way of construction of sign vectors (see Section 1.7). We give in the following a more detailed overview of the results presented in this chapter.

In Section 1.2 we will discuss some basic properties of tope sets and tope graphs, introducing  $L^1$ -systems and acycloids which are generalizations of the tope sets of oriented matroids. Tope graphs of  $L^1$ -systems and acycloids are well studied and have good characterizations (e.g., see [Djo73, FH93]).

We will prove a new separability property of tope graphs of oriented matroids in Section 1.3. This separability property, which can be checked easily, is not valid for general  $L^1$ -systems or acycloids, however, it is also not sufficient to characterize tope graphs of oriented matroids. Nevertheless, the separability property will be helpful again in Chapter 4 for the development of algorithms for the generation of oriented matroids.

In Section 1.4 we use properties from Section 1.2 to design a simple algorithm which reconstructs tope sets of oriented matroids (or, more general, acycloids) from a given tope graph. This orientation reconstruction is unique up to isomorphism, which also proves that the tope graph of an oriented matroid characterizes its isomorphism class. This also implies that the big face lattice of an oriented matroid characterizes its isomorphism class: Tope graphs (or face lattices) of oriented matroids are representations of the isomorphism classes of oriented matroids.

The known characterizations of tope sets of oriented matroids (e.g., see [BC87, Han90, dS95]) do not lead to algorithms which check in polynomial time whether a given set of sign vectors is the tope set of an oriented matroid. The same is true for tope graphs of oriented matroids: there is no direct (graph theoretical) characterization which can be checked in polynomial time (of course, the characterization problems of tope sets and tope graphs are connected by the polynomial orientation reconstruction). However, as a result of Fukuda, Saito, and Tamura [FST91], tope sets can be characterized in polynomial time using algorithms which reconstruct faces from tope sets. We present such algorithms in Section 1.5, present in Section 1.6 algorithms for the reconstruction of faces and topes from cocircuits, and combine all these in Section 1.7 for an algorithm which characterizes tope sets of oriented matroids in polynomial time.

## 1.2 Properties of Topes Graphs

We discuss in this section some basic properties of tope graphs of oriented matroids. These are the properties of the tope graphs of so-called  $L^1$ -systems and acycloids which generalize tope sets of oriented matroids [Tom84, Han90, Han93].

**1.2.1 Definition ( $L^1$ -System, Acycloid [Tom84])** A pair  $(E, \mathcal{T})$  of a finite set  $E$  and a set  $\mathcal{T} \subseteq \{-, +\}^E$  is called an  $L^1$ -system (also  $L^1$ -embeddable system) if

(A1) for all  $X, Y \in \mathcal{T}$  such that  $X \neq Y$  there exist  $e \in D(X, Y)$  and  $Z \in \mathcal{T}$  such that  $Z_e = -X_e$  and  $Z \setminus e = X \setminus e$ . (reorientation)

If in addition to the reorientation property also

(A2) if  $X \in \mathcal{T}$  then  $-X \in \mathcal{T}$ , (symmetry)

then we call  $(E, \mathcal{T})$  an *acycloid* (or *simple acycloid*).

A basic observation is the following [Han90]:

**1.2.2 Lemma** *Let  $(E, \mathcal{F})$  be a simple oriented matroid and  $\mathcal{T}$  its tope set. Then  $(E, \mathcal{T})$  is an acycloid.*

**Proof** Since there are no loops, the set of topes satisfies  $\mathcal{T} \subseteq \{-, +\}^E$ . As  $(E, \mathcal{F})$  is simple, (A1) is the same as the reorientation property of tope sets of oriented matroids (see Corollary 0.7.7). The symmetry (A2) is obviously implied by the symmetry of covectors (F1). ■

The following is a very important characterization of edges in tope graphs of  $L^1$ -systems (and hence oriented matroids) [FH93]:

**1.2.3 Lemma** *If  $(E, \mathcal{T})$  is an  $L^1$ -system and  $G$  its tope graph with associating bijection  $\mathcal{L} : V(G) \rightarrow \mathcal{T}$ , then  $E(G) = \{\{x, y\} \mid |D(\mathcal{L}(x), \mathcal{L}(y))| = 1\}$ .*

**Proof** The claim follows directly from the definition of a tope graph and the fact that  $L^1$  systems are simple, i.e., all parallel classes contain exactly one element. ■

The above lemma is used to prove the following important property of tope graphs of  $L^1$ -systems [FH93], which states that these graphs can be embedded isometrically in some (higher-dimensional) hypercube, where isometrically means that distances in the tope graph are the same as in the hypercube:

**1.2.4 Proposition** *If  $(E, \mathcal{T})$  is an  $L^1$ -system and  $G$  its tope graph with associating bijection  $\mathcal{L} : V(G) \rightarrow \mathcal{T}$ , then  $d_G(x, y) = |D(\mathcal{L}(x), \mathcal{L}(y))|$  for all  $x, y \in V(G)$ .*

**Proof** Let  $(E, \mathcal{T})$  be an  $L^1$ -system,  $G$  its tope graph, and  $\mathcal{L} : V(G) \rightarrow \mathcal{T}$  an associating bijection. We prove the claim by induction on  $|D(\mathcal{L}(x), \mathcal{L}(y))|$ .  $|D(\mathcal{L}(x), \mathcal{L}(y))| = 0$  clearly implies  $x = y$ . For  $|D(\mathcal{L}(x), \mathcal{L}(y))| = 1$  the claim follows from Lemma 1.2.3. For  $x, y \in V(G)$  set  $X := \mathcal{L}(x)$  and  $Y := \mathcal{L}(y)$ , and assume  $|D(X, Y)| > 1$ . Since  $X \neq Y$ , there exist  $e \in D(X, Y)$  and  $Z \in \mathcal{T}$  such that  $Z_e = -X_e$  and  $Z \setminus e = X \setminus e$ . There is  $z \in V(G)$  such that  $Z = \mathcal{L}(z)$ . Obviously  $|D(X, Z)| = 1$  and  $|D(Z, Y)| = |D(X, Y)| - 1$ , so  $d_G(x, z) = 1$  and by induction  $d_G(z, y) = |D(X, Y)| - 1$ . This implies  $d_G(x, y) \leq d_G(x, z) + d_G(z, y) = |D(X, Y)|$ . On the other hand Lemma 1.2.3 implies  $d_G(x, y) \geq |D(X, Y)|$ . ■

**1.2.5 Corollary ([FH93])** *For every vertex  $v$  in the tope graph  $G$  of an acycloid there exists a unique vertex  $\bar{v} \in V(G)$  such that  $d_G(v, \bar{v}) = \text{diam}(G)$ .*

**Proof** Let  $\mathcal{L} : V(G) \rightarrow \mathcal{T} \subseteq \{-, +\}^E$  be an associating bijection. By definition of an acycloid  $-\mathcal{L}(v) \in \mathcal{T}$ . Let  $\bar{v} \in V(G)$  be determined by  $\mathcal{L}(\bar{v}) = -\mathcal{L}(v)$ . By Proposition 1.2.4,  $d_G(v, \bar{v}) = |E|$  is the maximal distance between any vertices in  $G$  and is attained if and only if the vertices correspond to negative sign vectors in  $\mathcal{T}$ . ■

**1.2.6 Definition (Antipode)** Let  $G$  be the tope graph of an acycloid and  $v \in V(G)$ . We call the vertex  $\bar{v} \in V(G)$  determined by  $d_G(v, \bar{v}) = \text{diam}(G)$  *the antipode of  $v$  in  $G$ .*

Lemma 1.2.3 says that for every edge  $\{x, y\}$  in the tope graph  $G$  of an  $L^1$ -system  $(E, \mathcal{T})$ , where some associating bijection  $\mathcal{L} : V(G) \rightarrow \mathcal{T}$  is given, there is an element  $e \in E$  such that  $\mathcal{L}(x) = \frac{e}{e}\mathcal{L}(y)$ . We introduce the notion of an *edge class* for the collection of edges which corresponds to the same element. It will turn out that edge classes are independent from  $\mathcal{L}$ .

**1.2.7 Definition (Edge Class  $E^e$ ;  $C(v, w)$ )** Let  $(E, \mathcal{T})$  be an  $L^1$ -system and  $G$  its tope graph with associating bijection  $\mathcal{L} : V(G) \rightarrow \mathcal{T}$ . For  $e \in E$  we define *the edge class of  $e$*  by

$$E^e := \{\{v, w\} \in E(G) \mid D(\mathcal{L}(v), \mathcal{L}(w)) = \{e\}\}.$$

For an edge  $\{v, w\} \in E(G)$  we define

$$C(v, w) := \{x \in V(G) \mid d_G(x, v) < d_G(x, w)\}.$$

It is obvious that edge classes partition the set of edges. For an illustration see Figure 1.1, where edges of the same edge class are parallel. These edge classes are defined by the graph  $G$  itself, independent from  $\mathcal{L}$  (this result is essentially based on work of Djoković [Djo73]):

**1.2.8 Lemma** *Let  $G$  be the tope graph of an  $L^1$ -system  $(E, \mathcal{T})$  and  $\mathcal{L} : V(G) \rightarrow \mathcal{T}$  an associating bijection, furthermore let  $\{v, w\} \in E(G)$  be an arbitrary edge in  $G$ , say  $\{v, w\} \in E^e$  for some  $e \in E$ . Then*

$$C(v, w) = \{x \in V(G) \mid \mathcal{L}(x)_e = \mathcal{L}(v)_e\}$$

and

$$E^e = \{\{v', w'\} \in E(G) \mid v' \in C(v, w) \text{ and } w' \in C(w, v)\}.$$

**Proof** Set  $V := \mathcal{L}(v)$ ,  $W := \mathcal{L}(w)$ , and  $X := \mathcal{L}(x)$  for some  $x \in V(G)$ . By Proposition 1.2.4,  $d_G(x, v) = |D(X, V)|$  and  $d_G(x, w) = |D(X, W)|$ , hence  $d_G(x, v) < d_G(x, w)$  if and only if  $|D(X, V)| < |D(X, W)|$ , which is because of  $D(V, W) = \{e\}$  equivalent to  $X_e = V_e = -W_e$ . This proves that  $x \in C(v, w)$  if and only if  $X_e = V_e$ . Set  $V' := \mathcal{L}(v')$ ,  $W' := \mathcal{L}(w')$  for some  $\{v', w'\} \in E(G)$ . As  $v' \in C(v, w)$  and  $w' \in C(w, v)$  is equivalent to  $V'_e = V_e$  and  $W'_e = W_e$ ,  $D(V, W) = \{e\}$  implies  $e \in D(V', W')$ , hence  $\{v', w'\} \in E^e$ . On the other hand, if  $e \in D(V', W')$ , then (after possibly interchanging  $V'$  and  $W'$ , which does not change the edge since  $\{v', w'\} = \{w', v'\}$ )  $V'_e = V_e$  and  $W'_e = W_e$ , hence  $v' \in C(v, w)$  and  $w' \in C(w, v)$ . ■



We illustrate the results of this section for the case of oriented matroids of rank 2 (dimension 1). This case will be important for several later considerations in this thesis, for example for the characterization of oriented matroids of rank 2 in Corollary 1.4.4.

**1.2.9 Proposition (Tope Graph of Oriented Matroid of Rank 2)** *The tope graph of an oriented matroid  $(E, \mathcal{F})$  of rank 2 is a cycle of even length  $2n'$ , where  $n'$  is the number of parallel classes in  $\mathcal{F}/E^0$ , where  $E^0$  is the set of loops.*

Figure 1.2 shows an example of an oriented matroid of rank 2 and its tope graph, where the gray lines indicate a corresponding central arrangement of lines (i.e., the intersection of these lines with the unit sphere  $S^1$  induces a 1-dimensional sphere arrangement which realizes the oriented matroid).

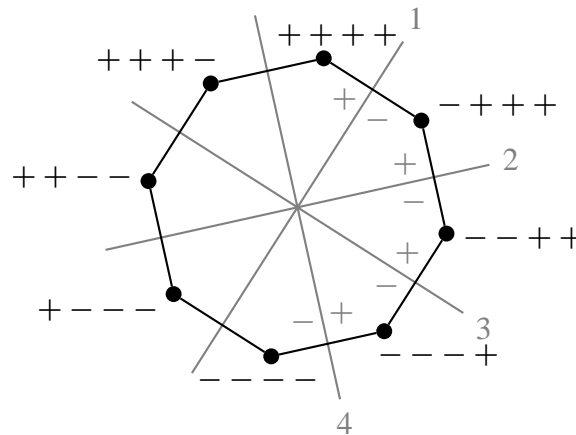

Figure 1.2: Tope graph of an oriented matroid of rank 2

**Proof of Proposition 1.2.9** Let  $\mathcal{M}$  be an oriented matroid of rank 2, and associate the topes to the vertices of the tope graph  $G$  of  $\mathcal{M}$  by an associating bijection  $\mathcal{L} : V(G) \rightarrow \mathcal{T}$  as in Definition 1.1.1.  $\text{rank}(\mathcal{M}) = 2$  obviously implies  $\mathbf{0} \notin \mathcal{T}$ , and by the symmetry of covectors (F1)  $2n' = |\mathcal{T}|$  for some integer  $n' > 0$ . The edges of  $G$  correspond to the cocircuits of the oriented matroid. The diamond property 0.7.13 implies that the degree of every vertex is 2. This implies that  $G$  consists of a set of cycles, and by Proposition 1.2.4  $G$  is connected, i.e.,  $G$  has the form of a cycle of length  $2n'$ , where then  $n' = \text{diam}(G) = |E'|$  for  $E'$  being the ground set of any simplification of  $\mathcal{M}$ . By definition,  $|E'|$  equals the number of parallel classes of non-loop elements. ■

In tope graphs of oriented matroids of rank 2 every edge class contains two edges which are have opposite positions in the cycle.

### 1.3 Separability of Uncut Topes

In this section we strengthen the results of Section 1.2 and prove a new property of tope graphs of oriented matroids which can be checked easily from the graph and which will

be helpful later for the design of generation algorithms. Examples will show that not all tope graphs of acycloids satisfy the stronger property, but also that it does not characterize tope graphs of oriented matroids.

We will state our results first in terms of sign vectors and then in terms of tope graphs. Let  $\mathcal{M} = (E, \mathcal{F})$  be a simple oriented matroid with tope set  $\mathcal{T}$ , and define for an arbitrary element  $f \in E$

$$\begin{aligned}\mathcal{T}^- &:= \{Z \in \mathcal{T} \mid Z_f = - \text{ and } \overline{f}Z \notin \mathcal{T}\}, \\ \mathcal{T}^+ &:= \{Z \in \mathcal{T} \mid Z_f = + \text{ and } \overline{f}Z \notin \mathcal{T}\}, \\ \mathcal{T}^0 &:= \{Z \in \mathcal{T} \mid \overline{f}Z \in \mathcal{T}\},\end{aligned}$$

where  $\overline{f}Z$  is the sign vector obtained from  $Z$  by reversing the sign of element  $f$ . We will say that the topes in  $\mathcal{T}^-$  and  $\mathcal{T}^+$  are *not cut by  $f$*  or simply *uncut*. The motivation for this name comes from considering sphere arrangements and the deletion minor  $\mathcal{M} \setminus f$ . If the sphere  $S_f$  is inserted in the arrangement according to  $\mathcal{M} \setminus f$ , then some of the regions of the minor remain unchanged, some are *cut* by  $S_f$  into two new regions. The topes in  $\mathcal{T}^-$  and  $\mathcal{T}^+$  correspond to regions which remain uncut (either on the  $-$  or on the  $+$  side of  $S_f$ ), the topes in  $\mathcal{T}^0$  correspond to regions obtained by a cut.

We will show that the vertices in  $\mathcal{T}^-$  (and, by symmetry, similarly the vertices in  $\mathcal{T}^+$ ) are connected in the sense of adjacency in tope graphs:

**1.3.1 Theorem** *Let  $\mathcal{M} = (E, \mathcal{F})$  be a simple oriented matroid with tope set  $\mathcal{T}$ . Choose an arbitrary element  $f \in E$ . For any two topes  $X, Y \in \mathcal{T}^-$  there exists a sequence  $X = Z^0, \dots, Z^k = Y$  such that  $Z^i \in \mathcal{T}^-$  for  $i \in \{0, \dots, k\}$  and  $|D(Z^{i-1}, Z^i)| = 1$  for  $i \in \{1, \dots, k\}$ .*

Before we prove this connectedness property we give some remarks. First, we show in Figure 1.3 an example for the analogous *affine* case where the connectedness in the sense of Theorem 1.3.1 is not valid (in the example the gray regions are those  $d$ -faces not cut by the new hyperplane  $f$ , and obviously  $X$  and  $Y$  are not connected on the  $-$  side of  $f$ ). In order to see the connectedness in the sense of Theorem 1.3.1, the line arrangement has to be embedded on the front side of a sphere with a corresponding extension to the back side; the uncut regions then become connected through the back part of the sphere (see also case (i) in Figure 1.6).

An immediate consequence of Theorem 1.3.1 is the separability of uncut topes (note that because of Lemma 1.2.8 the edge classes of  $G$  are defined by  $G$  itself, without associating bijection  $\mathcal{L}$ ):

**1.3.2 Corollary** *Let  $G$  be the tope graph of an oriented matroid and  $E^f \subseteq E(G)$  an edge class. Denote by  $V^0$  the set of vertices incident to some edge in  $E^f$ , then the subgraph of  $G$  induced by the vertices  $V(G) \setminus V^0$  has either no or exactly two connected components.*

**Proof** There exists a simple oriented matroid  $\mathcal{M}$  such that  $G$  is the tope graph of  $\mathcal{M}$  with associating bijection  $\mathcal{L} : V(G) \rightarrow \mathcal{T} \subseteq \{-, +\}^E$ . By the definition of edge classes there exists  $f \in E$  such that  $\mathcal{L}$  maps  $V^0$  to  $\mathcal{T}^0 = \{Z \in \mathcal{T} \mid \overline{f}Z \in \mathcal{T}\}$ . If  $\mathcal{T} \setminus \mathcal{T}^0 \neq \emptyset$  then

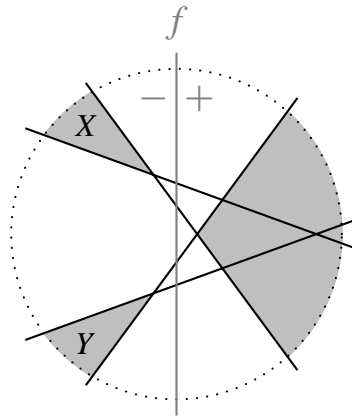

Figure 1.3: Example for non-connectedness in the affine case

Theorem 1.3.1 implies that there are exactly two connected components in the subgraph of  $G$  induced by the vertices  $V(G) \setminus V^0$ , one corresponding to  $\mathcal{T}^-$ , the other corresponding to  $\mathcal{T}^+$ . ■

The result of Corollary 1.3.2 implies that if there exist uncut tope then they are separated by the tope which are cut in a  $-$  part and a  $+$  part as they belong to  $\mathcal{T}^-$  and  $\mathcal{T}^+$ ; the only ambiguity is the orientation of the corresponding element  $f$  which defines  $E^f$ .

**1.3.3 Definition (Separable Tope Graph)** Let  $G$  be the tope graph of an  $L^1$ -system and  $E^f$  an edge class in  $G$ . We say that  $G$  is *separable w.r.t.  $E^f$*  (or, if an associating bijection is given such that  $f \in E$  defines the edge class  $E^f$ ,  $G$  is *separable w.r.t.  $f$* ) if the separability holds for this edge class  $E^f$ : the subgraph of  $G$  induced by the vertices  $V(G) \setminus V^0$  has either no or exactly two connected components, where  $V^0$  denotes the set of vertices incident to some edge in  $E^f$ . We call  $G$  *separable* if  $G$  is separable w.r.t. all edge classes.

We present two examples which show that not all tope graphs of acycloids are separable (see Figure 1.4), but also that not all separable tope graphs of acycloids are tope graphs of oriented matroids (see Figure 1.5). Both examples have a ground set  $E = \{1, 2, 3, 4, 5\}$ . The tope graph in Figure 1.4 is separable only w.r.t. element 1 but not separable w.r.t. 2, 3, 4, or 5, which can be seen by inspection. The acycloid in Figure 1.5 is not an oriented matroid, but its tope graph is separable. Again, separability is not difficult to see, but the proof that the acycloid is not an oriented matroid is not obvious. Actually the example has been found by computer support. A formal proof can be found by use of the method for the construction of faces from a tope set (see Section 1.5).

We give a sketch of the proof of Theorem 1.3.1. Consider two regions  $X$  and  $Y$  which are not cut by the element  $f$  and are on the same side of  $f$ , say the  $-$  side. There exists an element  $g \in E \setminus f$  that bounds  $X$  and does not separate  $X$  and  $Y$ ; if we consider  $g$  as an *infinity element*, we may call  $X$  an unbounded region. There are two cases to consider: (i)  $Y$  is also an unbounded region and (ii)  $Y$  is not an unbounded region. The two cases are illustrated in Figure 1.6 showing the  $-$  side of  $f$  only; note that case (i), restricted to affine space (i.e., to the  $+$  side of  $g$ ), is exactly the example of Figure 1.3. In case (i) we consider the contraction w.r.t.  $g$  and use a non-trivial inductive argument to prove

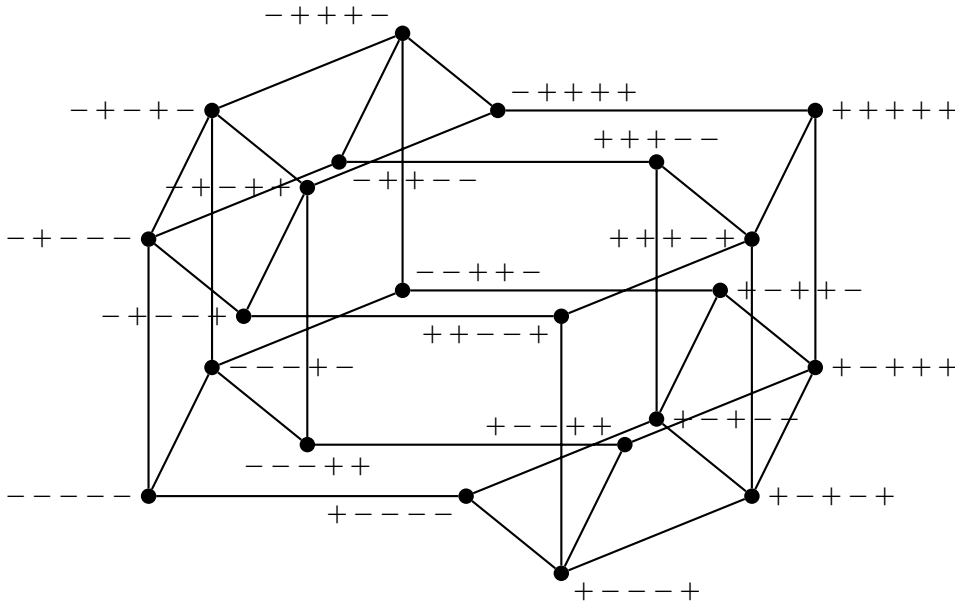

Figure 1.4: Acycloid whose tope graph is not separable

that  $X$  and  $Y$  are connected in the sense of Theorem 1.3.1. In case (ii) we show that  $Y$  is connected in the sense of Theorem 1.3.1 to an unbounded region  $Y'$ , which is known to be connected to  $X$  because of case (i). The unbounded region  $Y'$  is found using an oriented matroid program (see Definition 0.8.1) which has an optimal solution  $U$ . The solution  $U$  defines an unbounded cone (hatched with white lines in Figure 1.6) which contains regions that are all connected in the sense of Theorem 1.3.1.

**Proof of Theorem 1.3.1** The proof is by induction on the rank of  $\mathcal{M}$ . For some small rank  $r$ , say  $r \leq 2$ , the proof is obviously true (for the case of rank  $r = 2$  see also Proposition 1.2.9). Consider  $\mathcal{M}$  with  $\text{rank}(\mathcal{M}) \geq 3$ . If  $\mathcal{T}^- = \emptyset$  then the claim is trivially true, so assume  $\mathcal{T}^- \neq \emptyset$ . Let  $X, Y \in \mathcal{T}^-$ . Then  $X_f = Y_f = -$  implies  $X \neq -Y$ , and by the reorientation property (A1) (cf. Lemma 1.2.2) applied to  $X$  and  $-Y$  there is  $g \in D(X, -Y) = E \setminus D(X, Y)$  such that  $\overline{g}X \in \mathcal{T}$ .  $X \in \mathcal{T}^-$  implies  $g \neq f$ . Obviously  $X_g = Y_g \neq 0$ , and without loss of generality assume  $X_g = Y_g = +$ .

- (i) If  $\overline{g}Y \in \mathcal{T}$ : Consider the contraction minor  $\mathcal{M}/g$  (i.e., the contraction of  $\mathcal{M}$  to faces which contain  $g$  in the zero support) which is a (not necessarily simple) oriented matroid whose rank is  $\text{rank}(\mathcal{M}) - 1$  (see Corollary 0.4.9 (ii)). Denote by  $\tilde{\mathcal{M}}$  a simplification of  $\mathcal{M}/g$  where the parallel class containing  $f$  is represented by  $f$ . Note that  $X \setminus g \in \mathcal{M}/g$  and  $Y \setminus g \in \mathcal{M}/g$ , and denote by  $\tilde{X}$  and  $\tilde{Y}$  their images in  $\tilde{\mathcal{M}}$ , then  $\tilde{X}, \tilde{Y} \in \tilde{\mathcal{T}}^-$ , where  $\tilde{\mathcal{T}}^-$  is defined for  $\tilde{\mathcal{M}}$  as  $\mathcal{T}^-$  for  $\mathcal{M}$ . By induction, there exists a sequence  $\tilde{X} = \tilde{U}^0, \dots, \tilde{U}^k = \tilde{Y}$  in  $\tilde{\mathcal{T}}^-$  such that  $|D(\tilde{U}^{i-1}, \tilde{U}^i)| = 1$  for  $i \in \{1, \dots, k\}$ . Consider  $i \in \{0, \dots, k\}$ :  $\tilde{U}^i \in \tilde{\mathcal{T}}^-$  implies that there exist  $U^i \in \mathcal{T}$  such that  $U^i_g = +$  and  $\overline{g}U^i \in \mathcal{T}$ , where  $\tilde{U}^i$  is the image of  $U^i \setminus g$  in  $\tilde{\mathcal{M}}$ ; furthermore  $U^i_f = -$ , and at most one of  $\overline{f}U^i$  and  $\overline{\{f,g\}}U^i$  is in  $\mathcal{T}$ , i.e., at least one of  $U^i$  and  $\overline{g}U^i$  is in  $\mathcal{T}^-$ . We define  $\hat{U}^i := U^i$  if  $U^i \in \mathcal{T}^-$ , otherwise  $\hat{U}^i := \overline{g}U^i \in \mathcal{T}^-$ . Since  $\hat{U}^0 = X$  and  $\hat{U}^k = Y$ , it remains to show that  $\hat{U}^{i-1}$  and  $\hat{U}^i$  are connected within  $\mathcal{T}^-$  for all  $i \in \{1, \dots, k\}$  in the sense of the claim.

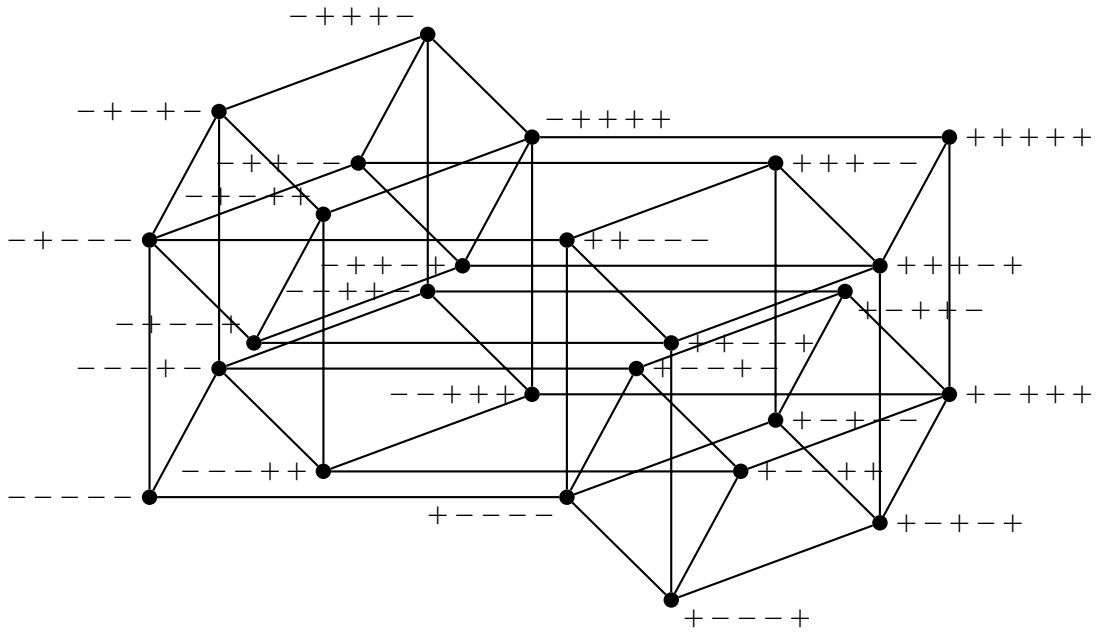

Figure 1.5: Acycloid which is not an oriented matroid but whose tope graph is separable

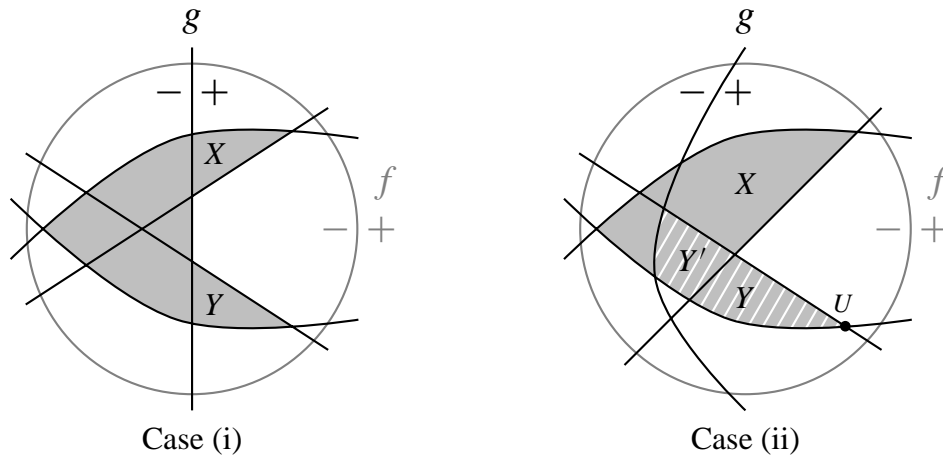

Figure 1.6: The two cases in the proof of Theorem 1.3.1

Consider  $i \in \{1, \dots, k\}$ . By Proposition 1.2.4, there exist two sequences  $U^{i-1} = V^0, \dots, V^d = U^i$  and  $\overline{g}U^{i-1} = W^0, \dots, W^d = \overline{g}U^i$  with  $|D(V^{j-1}, V^j)| = |D(W^{j-1}, W^j)| = 1$  for all  $j \in \{1, \dots, d\}$ , where  $d = |D(U^{i-1}, U^i)|$ . If at least one of the two sequences for  $i \in \{1, \dots, k\}$  lies entirely in  $\mathcal{T}^-$ , the claim follows by combining all these sequences in  $\mathcal{T}^-$ . Assume that for some  $i \in \{1, \dots, k\}$  neither of the two sequences is entirely in  $\mathcal{T}^-$ , i.e., there exist  $s, t \in \{0, \dots, d\}$  such that  $V' := \overline{f}V^s \in \mathcal{T}$  and  $W' := \overline{f}W^t \in \mathcal{T}$ . Covector elimination (F3) applied to  $V'$ ,  $W'$ , and  $g$  implies that there exists  $Z \in \mathcal{F}$  such that  $Z_g = 0$  and  $Z_e = (V' \circ W')_e$  for  $e \notin D(V', W')$ , i.e.,  $Z_e = V'_e = W'_e$  for  $e \notin D(V', W')$ , especially  $Z_f = +$ . Note that  $D := D(U^{i-1}, U^i)$  is a parallel class of  $\mathcal{M}/g$ , so  $Z_D = \mathbf{0}$ ,  $Z_D = \hat{U}_D^{i-1}$ , or  $Z_D = \hat{U}_D^i$ , and with  $D(V', W') \subseteq D \cup \{g\}$  it follows that  $Z \circ \hat{U}^{i-1} = \overline{f}\hat{U}^{i-1} \in \mathcal{T}$  or  $Z \circ \hat{U}^i = \overline{f}\hat{U}^i \in \mathcal{T}$ , a contradiction.

(ii) If  $\overline{g}Y \notin \mathcal{T}$ : We show that  $Y$  is connected within  $\mathcal{T}^-$  in the sense of the claim to some  $Y' \in \mathcal{T}^-$  for which  $\overline{g}Y' \in \mathcal{T}$ ; then the claim follows from (i). Without loss of generality assume  $Y_e = +$  for all  $e \in E \setminus \{f\}$  (reorientation does not affect connectedness within  $\mathcal{T}^-$ ). Consider the oriented matroid program  $(\mathcal{M}, g, f)$ , see Definition 0.8.1. Since  $Y$  is feasible for  $(\mathcal{M}, g, f)$ , and since no unbounded augmenting direction  $Z \in \mathcal{F}$  exists (otherwise  $Z \circ Y = \overline{f}Y \in \mathcal{T}$ , a contradiction), Theorem 0.8.4 implies that there exists an optimal solution  $U \in \mathcal{F}$  for  $(\mathcal{M}, g, f)$ ; note that  $U \setminus f \geq 0$ ,  $U_g = +$ , and  $U_f \leq 0$  (since  $U_f = +$  implies  $U \circ Y = \overline{f}Y \in \mathcal{T}$ ). Set  $V := -U \circ Y \in \mathcal{T}$ . By Proposition 1.2.4, there exists a sequence  $Y = W^0, \dots, W^d = V \in \mathcal{T}$  such that  $|D(W^{i-1}, W^i)| = 1$  for  $i \in \{1, \dots, d\}$ , where  $d = |D(Y, V)|$ . Since  $Y_g = +$  and  $V_g = -U_g = -$ , there exists  $k \in \{1, \dots, d\}$  such that  $W^i_g = +$  for  $i < k$  and  $W^k_g = -$ . Set  $Y' := W^{k-1}$ , then  $\overline{g}Y' = W^k \in \mathcal{T}$ , and it remains to show that  $W^i \in \mathcal{T}^-$  for  $i \in \{1, \dots, k-1\}$ . Assume  $W^i \notin \mathcal{T}^-$  for some  $i \in \{1, \dots, k-1\}$ , i.e., there exists  $W' \in \mathcal{T}$  such that  $W' \setminus f = W^i \setminus f$  and  $W'_f = +$ . Apply covector elimination (F3) to  $W'$ ,  $-U$ , and  $g$ : There exists  $Z' \in \mathcal{F}$  such that  $Z'_g = 0$  and  $Z'_e = (W' \circ -U)_e$  for  $e \notin D(W', -U)$ , especially  $Z'_f = +$ , and, for all  $e \neq f$  with  $U_e = 0$ ,  $V_e = Y_e = +$ , so also  $W'_e = +$  and  $Z'_e = W'_e = +$ , i.e.,  $Z'$  is an augmenting direction for  $U$ , in contradiction to the optimality of  $U$ .  $\blacksquare$

## 1.4 Orientation Reconstruction

We discuss now how one can find from a tope graph the underlying acycloid up to isomorphism. The results of Section 1.2 lead to an algorithm `ACYCLOIDORIENTATIONRECONSTRUCTION` (see Pseudo-Code 1.1) which efficiently reconstructs the sign vectors of an acycloid from a tope graph (almost the same algorithm is also given in [CF93] in the proof of Theorem 4.1).

**1.4.1 Proposition ([CF93])** *The algorithm `ACYCLOIDORIENTATIONRECONSTRUCTION` constructs an acycloid  $\mathcal{T} = \{\mathcal{L}(v) \mid v \in V(G)\} \subseteq \{-, +\}^E$  such that  $G$  is the tope graph of  $\mathcal{T}$  with associating bijection  $\mathcal{L}$  in time  $O(n \cdot |V(G)| \cdot |E(G)|)$ , where  $n = \text{diam}(G) = |E|$ .  $\mathcal{T}$  is unique up to labeling and orientation of the elements in  $E$ .*

For an oriented matroid, the complexity of `ACYCLOIDORIENTATIONRECONSTRUCTION` is  $O(n \cdot f_d \cdot f_{d-1})$ , as  $f_d = |V(G)|$  and  $f_{d-1} = |E(G)|$ .

**Proof of Proposition 1.4.1** Consider  $x \in V(G)$  and its antipode  $\overline{x}$ , which is determined by  $d_G(v, \overline{v}) = \text{diam}(G) =: n$  (see Corollary 1.2.5). By Proposition 1.2.4,  $x$  and  $\overline{x}$  correspond to negative sign vectors in the acycloid, say  $\mathcal{L}(x) = X = (+ \dots +)$  and  $\mathcal{L}(\overline{x}) = -X = (- \dots -)$  for  $X \in \{-, +\}^E$  with  $E = \{1, \dots, n\}$  (we are free to label the elements arbitrarily, also to choose some initial orientation for  $X$ ). Let  $x = x^0, x^1, \dots, x^n = \overline{x}$  be a shortest path connecting  $x$  and  $\overline{x}$ . Because of Proposition 1.2.4,  $|D(\mathcal{L}(x^e), \mathcal{L}(x))| = e$  for  $e \in E$ , and as we still are free to permute  $E$  arbitrarily, we can set  $\mathcal{L}(x^e)_f = +$  if  $f > e$  and  $\mathcal{L}(x^e)_f = -$  otherwise. By this all  $\mathcal{L}(x^e)$  are

*Input:* A graph  $G$  which is tope graph of some acycloid.  
*Output:* For every  $v \in V(G)$  a sign vector  $\mathcal{L}(v) \in \{-, +\}^E$ , where  $E = \{1, \dots, n\}$  with  $n = \text{diam}(G)$ .

```

begin ACYCLOIDORIENTATIONRECONSTRUCTION( $G$ );
  choose any  $x \in V(G)$  and determine  $\bar{x} \in V(G)$ ;
  choose any shortest path  $x = x^0, x^1, \dots, x^n = \bar{x}$  connecting  $x$  and  $\bar{x}$ ;
  for every  $e \in \{1, \dots, n\}$  and every  $v \in V(G)$  do
    if  $d_G(v, x^{e-1}) < d_G(v, x^e)$  then
       $\mathcal{L}(v)_e := +$ 
    else
       $\mathcal{L}(v)_e := -$ 
    endif
  endfor;
  return  $\mathcal{L}(v)$  for all  $v$ 
end ACYCLOIDORIENTATIONRECONSTRUCTION.

```

Pseudo-Code 1.1: Algorithm ACYCLOIDORIENTATIONRECONSTRUCTION

defined, and we will see that this determines also all remaining  $\mathcal{L}(v)$  for  $v \in V(G)$ . Let  $v \in V(G)$ . Then for a correct associating bijection  $\mathcal{L}$ ,  $v \in C(x^{e-1}, x^e)$  if and only if  $\mathcal{L}(v)_e = \mathcal{L}(x^{e-1})_e = +$  (see Lemma 1.2.8). For the complexity note that the computation of distances or shortest paths between given vertices costs not more than  $O(|E(G)|)$ . ■

It was first proved by Björner, Edelman, and Ziegler [BEZ90] that the tope graph determines an oriented matroid up to isomorphism. This results now follows from the reconstruction algorithm:

**1.4.2 Corollary** *The tope graph of an acycloid determines the acycloid up to isomorphism. As simple oriented matroids are acycloids, the same result is true for tope graphs of oriented matroids.*

**1.4.3 Corollary** *The big face lattice of an oriented matroid  $\mathcal{M}$  determines its isomorphism class  $\text{IC}(\mathcal{M})$ .*

**Proof** Note that the tope graph of  $\mathcal{M}$  is determined by the big face lattice. ■

**1.4.4 Corollary (Oriented Matroids of Rank 2)** *Let  $\mathcal{M} = (E, \mathcal{F})$  be an oriented matroid of rank 2, and let  $n'$  be the number of parallel classes in  $\mathcal{F}/E^0$ , where  $E^0$  is the set of loops of  $\mathcal{M}$ . Then  $\mathcal{M}$  is isomorphic to  $(E', \mathcal{F}')$  with  $E' = \{1, \dots, n'\}$  and  $\mathcal{F}' = \{\mathbf{0}\} \cup \mathcal{D}' \cup \mathcal{T}'$ , where the set of cocircuits  $\mathcal{D}'$  contains the  $2n'$  sign vectors  $X^i$  and  $-X^i$ , where  $X_j^i = \text{sign}(i - j)$  for  $i, j \in \{1, \dots, n'\}$ , and the set of topes  $\mathcal{T}'$  contains the  $2n'$  sign vectors  $Y^i$  and  $-Y^i$ , where  $Y_j^i = -$  if  $i \leq j$  and  $Y_j^i = +$  otherwise for  $i, j \in \{1, \dots, n'\}$ .*

**Proof** By Proposition 1.2.9 is the tope graph  $G$  of  $(E, \mathcal{F})$  a cycle of length  $2n'$ , and so is also the tope graph of  $(E, \mathcal{F}')$ . Hence, by Corollary 1.4.2,  $(E, \mathcal{F})$  and  $(E, \mathcal{F}')$  are isomorphic. It is not difficult to see that  $(E', \mathcal{F}')$  is an oriented matroid. An illustration is found in Figure 1.2. ■

## 1.5 Face Reconstruction from Topes

This section first contains some of the results on the number of faces from Section 2 of Fukuda, Saito, Tamura [FST91], with some minor extensions. We will use the notion of faces in place of covectors as we consider their mutual facial relation and their position w.r.t. the face lattice of the oriented matroid. Furthermore, we show an algorithm from [FST91] which constructs the set of all oriented matroid faces  $\mathcal{F}$  from the set of topes  $\mathcal{T}$  in time  $O(n^3 f_d^2)$ , where  $n$  is the cardinality of the ground set  $E$  and  $f_d = |\mathcal{T}|$ . Remember that for a given oriented matroid  $(E, \mathcal{F})$  and  $i \in \{-1, \dots, d\}$ ,  $\mathcal{F}_i$  denotes set of faces of dimension  $i$  in  $\mathcal{F}$  (which we call  $i$ -faces) and  $f_i = |\mathcal{F}_i|$ .

The main result used in the following is

**1.5.1 Theorem ([FST91])** *Let  $\mathcal{M}$  be an oriented matroid of dimension  $d := \dim(\mathcal{M})$ . Then  $f_i \leq \binom{d}{i} f_d$  for all  $i \in \{0, \dots, d\}$ .*

**Proof** See Theorem 1.1 in [FST91]. ■

**1.5.2 Corollary ([FST91])** *For any oriented matroid  $\mathcal{M}$  of dimension  $d$  holds  $f_0 \leq f_d$ .*

Finally we need a lower bound on the number of topes in an oriented matroid:

**1.5.3 Lemma** *For any oriented matroid  $\mathcal{M}$  of dimension  $d$  holds  $2^{d+1} \leq f_d$ .*

The above lower bound is better than the one given in [FST91], which is  $\binom{d}{i} \leq f_d$  for any  $i \in \{0, \dots, d\}$ .

**Proof of Lemma 1.5.3** Let  $\mathcal{M} = (E, \mathcal{F})$  be an oriented matroid of dimension  $d$ , i.e., of rank  $r = d + 1$ . If  $r = 0$  then  $2^{d+1} = 1 = f_d$ ; assume for the following  $r \geq 1$ . Let  $B$  be a basis of  $E$ , so  $|B| = r$ . As  $B$  is an independent set, it does not contain loops. Consider the deletion minor  $\mathcal{M}' := \mathcal{M} \setminus (E \setminus B)$ , an oriented matroid with ground set  $B$ . By Corollary 0.4.6 (i),  $\text{rank}(\mathcal{M}') = \text{rank}_{\underline{\mathcal{M}}}(B) = r$ . If  $X$  is a cocircuit in  $\mathcal{M}'$  then  $\text{rank}_{\mathcal{M}'}(X) = 1$  (see Corollary 0.7.11), and by definition  $\text{rank}_{\underline{\mathcal{M}'}}(X^0) = r - 1$ , but then  $|X^0| = r - 1$ . As for every element  $e \in E$  which is not a loop there exists a cocircuit  $X$  such that  $e \in \underline{X}$  (cf. Lemma 0.6.2), the set of cocircuits of  $\mathcal{M}'$  is the set of the  $2r$  sign vectors  $X \in \{-, +, 0\}^B$  such that  $|X^0| = r - 1$ . Let  $\mathcal{T}'$  denote the tope set of  $\mathcal{M}'$ , then Corollary 0.6.4 implies that  $\mathcal{T}' = \{-, +\}^B$ . It is obvious that for every  $Z' \in \mathcal{T}'$  there exists  $Z \in \mathcal{T}$  such that  $Z' = Z_B$ , therefore  $|\mathcal{T}'| = 2^r = 2^{d+1} \leq |\mathcal{T}| = f_d$ . ■

**1.5.4 Corollary ([FST91])** *For any oriented matroid  $\mathcal{M}$  holds  $|\mathcal{F}| \leq |\mathcal{T}|^2$ , where  $\mathcal{T}$  is the set of topes of  $\mathcal{M}$ .*



**Proof** Set  $d := \dim(\mathcal{M})$  and apply Theorem 1.5.1 and Lemma 1.5.3 (note that by definition  $\mathcal{T} \neq \emptyset$ ):

$$|\mathcal{F}| = 1 + \sum_{i=0}^d f_i \leq 1 + \sum_{i=0}^d \binom{d}{i} f_d = 1 + 2^d |\mathcal{T}| \leq 2^{d+1} |\mathcal{T}| \leq |\mathcal{T}|^2. \quad \blacksquare$$

**1.5.5 Lemma** *Let  $(E, \mathcal{F})$  be an oriented matroid and  $X \in \mathcal{F}$ . Then the parallel classes of  $\mathcal{F}/X^0$  and  $\mathcal{F}(\underline{X}) := \{Z \in \mathcal{F} \mid \underline{Z} = \underline{X}\}$  are the same.*

**Proof**  $\mathcal{F}/X^0$  is a set of covectors whose set of topes is  $\mathcal{F}(\underline{X})$ . ■

The key lemma is the following characterizations of lower faces, which is also used in [FST91]. We add a proof which is basically a consequence of Lemma 0.7.6.

**1.5.6 Lemma** *Let  $(E, \mathcal{F})$  be an oriented matroid of dimension  $d := \dim(\mathcal{M})$ . For any  $i \in \{0, \dots, d-1\}$ ,  $Z \in \mathcal{F}_i$  if and only if there exist  $X, Y \in \mathcal{F}_{i+1}$  such that  $\underline{X} = \underline{Y}$  and  $D := D(X, Y)$  is a parallel class of  $\mathcal{F}(\underline{X}) := \{Z \in \mathcal{F} \mid \underline{Z} = \underline{X}\}$  and  $Z \setminus D = X \setminus D$  and  $Z_D = \mathbf{0}$ .*

**Proof** Let  $(E, \mathcal{F})$  be an oriented matroid,  $d := \dim(\mathcal{M})$ , and  $i \in \{0, \dots, d-1\}$ . Let for  $X \in \mathcal{F}$  be  $\mathcal{F}(\underline{X}) := \{Z \in \mathcal{F} \mid \underline{Z} = \underline{X}\}$ .

Assume that there exist  $X, Y \in \mathcal{F}_{i+1}$  such that  $\underline{X} = \underline{Y}$  and  $D := D(X, Y) \neq \emptyset$  is a parallel class of  $\mathcal{F}(\underline{X})$ . Apply conformal elimination to  $X, Y$ , and  $D$ : There exists  $e \in D$  and  $Z \in \mathcal{F}$  such that  $Z_e = 0$ ,  $Z_D \leq X_D$ , and  $Z \setminus D = (X \circ Y) \setminus D = X \setminus D$ . Then  $Z \prec X$  and  $\mathbf{0} = Z_D$  since  $D$  is a parallel class of  $\mathcal{F}/X^0$  (because of Lemma 1.5.5,  $Z \in \mathcal{F}/X^0$ , and Lemma 0.7.5). As  $D = Z^0 \setminus X^0$ , Lemma 0.7.6 implies  $Z \in \mathcal{F}_i$ .

Let  $Z \in \mathcal{F}_i$ . As  $i < d$  there exists  $X \in \mathcal{F}_{i+1}$  such that  $Z \prec X$ . Set  $Y := Z \circ (-X)$ , then  $\underline{X} = \underline{Y}$  and  $Y \in \mathcal{F}_{i+1}$ , and for  $D := D(X, Y)$  follows  $Z \setminus D = X \setminus D$  and  $Z_D = \mathbf{0}$ . By Lemma 0.7.6,  $D$  is a parallel class of  $\mathcal{F}/X^0$ , hence by Lemma 1.5.5 also a parallel class of  $\mathcal{F}(\underline{X})$ . ■

The above lemma immediately leads to an algorithm LOWERFACES (see Pseudo-Code 1.2) which returns for every  $i \in \{0, \dots, d-1\}$  and input  $\mathcal{W} := \mathcal{F}_{i+1}$  the set of lower faces  $\mathcal{F}_i$ . This algorithm is the key subroutine for the face enumeration algorithm FACEENUMERATION (see Pseudo-Code 1.3) which returns for input  $\mathcal{T} = \mathcal{F}_d$  the list  $(\mathcal{F}_{-1}, \dots, \mathcal{F}_d)$  ordered by dimension. Our presentation follows essentially [FST91], with one difference which makes the complexity analysis easier: we change the inner **for**-loop of the algorithm such that every  $X \in \mathcal{W}_j$  and every parallel class  $D$  of  $\mathcal{W}_j$  is considered, where in the original algorithm pairs  $X, Y \in \mathcal{W}_j$  are considered which are then tested for  $D(X, Y)$  being a parallel class of  $\mathcal{W}_j$ . The computation of parallel classes of a set of sign vectors of same support is easy when omitting loops and reorienting such that  $(+ \dots +)$  is one of the sign vectors being considered.

**1.5.7 Theorem ([FST91])** *Let  $(E, \mathcal{F})$  be an oriented matroid with tope set  $\mathcal{T}$ . The algorithm FACEENUMERATION started with input  $\mathcal{W}_0 := \mathcal{T}$  returns  $(\mathcal{F}_{-1}, \dots, \mathcal{F}_d)$ , i.e., the algorithm enumerates all faces in  $\mathcal{F}$  ordered by dimension. There exist implementations such that the algorithm has a complexity (measured by the number of elementary operations) of at most  $O(n^3 f_d^2)$ , where  $n$  is the cardinality of the ground set  $E$ .*

*Input:* A set of sign vectors  $\mathcal{W} \subseteq \{-, +, 0\}^E$ .  
*Output:* A set of sign vectors  $\mathcal{W}' \subseteq \{-, +, 0\}^E$ .

```

begin LOWERFACES( $\mathcal{W}$ );
  partition  $\mathcal{W}$  into classes  $\mathcal{W}_j$  of sign vectors having the same support;
   $\mathcal{W}' := \emptyset$ ;
  for every  $\mathcal{W}_j$  do
    compute the collection of parallel classes of  $\mathcal{W}_j$ ;
    for every  $X \in \mathcal{W}_j$  and every parallel class  $D$  of  $\mathcal{W}_j$  do
      if  $X_D \neq \mathbf{0}$  and  $\overline{D}X \in \mathcal{W}_j$  then
         $\mathcal{W}' := \mathcal{W}' \cup \{Z \mid Z \setminus D = X \setminus D \text{ and } Z_D = \mathbf{0}\}$ 
      endif
    endfor
  endfor;
  return  $\mathcal{W}'$ 
end LOWERFACES.

```

Pseudo-Code 1.2: Algorithm LOWERFACES

*Input:* A set of sign vectors  $\mathcal{W}_0 \subseteq \{-, +, 0\}^E$ .  
*Output:* An ordered list  $(\mathcal{W}_{-j}, \dots, \mathcal{W}_0)$  of sets of sign vectors  $\mathcal{W}_i \subseteq \{-, +, 0\}^E$  for some  $j$ .

```

begin FACEENUMERATION( $\mathcal{W}_0$ );
   $i := 0$ ;
  while  $\mathcal{W}_{-i} \neq \{\mathbf{0}\}$  and  $\mathcal{W}_{-i} \neq \emptyset$  do
     $\mathcal{W}_{-i-1} := \text{LOWERFACES}(\mathcal{W}_{-i})$ ;
     $i := i + 1$ 
  endwhile;
  return  $(\mathcal{W}_{-i}, \dots, \mathcal{W}_0)$ 
end FACEENUMERATION.

```

Pseudo-Code 1.3: Algorithm FACEENUMERATION

**Proof** We do not give a detailed analysis (for this see [FST91]). The algorithm LOWERFACES has a complexity of at most  $O(n^3 f_{i+1})$  to enumerate  $\mathcal{F}_i$  from  $\mathcal{F}_{i+1}$  if the sign vectors are sorted appropriately. This leads to an overall complexity for FACEENUMERATION of  $O(n^3 |\mathcal{F}|)$  which is at most  $(n^3 f_d^2)$  because of Corollary 1.5.4 (note that if the algorithm is extended such that it stops with failure message if the number of sign vectors collected exceeds  $f_d^2$  then the polynomial complexity is also valid for input  $\mathcal{T}$  which is not the tope set of an oriented matroid). ■

## 1.6 Construction of Covectors and Topes from Cocircuits

In the previous section we have described a polynomial algorithm for the construction of covectors (and hence also cocircuits) from topes. In this section we discuss how to construct sets of covectors  $\mathcal{F}$  or topes  $\mathcal{T}$  from a given set of cocircuits  $\mathcal{D}$  in polynomial time, measured in input and output as  $|\mathcal{F}|$  and  $|\mathcal{T}|$  are usually not polynomial in  $|\mathcal{D}|$ . By this we use an extended notion of polynomiality which has been introduced by Fukuda [Fuk96, Fuk00a, Fuk01]. Our construction methods of this section complete the presentation in [FST91] where such algorithms have not been presented but have been implicitly assumed to exist. We suppose that such algorithms may have been developed by the authors of [FST91] without stating it.

We present two algorithms, COVECTORSFROMCOCIRCUITS (see Pseudo-Code 1.4) and TOPESFROMCOCIRCUITS (see Pseudo-Code 1.5) which are similar, both are based on the fact that every covector has a representation by conformal decomposition (see Proposition 0.6.3). We use in the algorithms the data structure of *balanced binary trees* (also called *AVL-trees* [AVL62, Knu73]) which allow to store data such that the operations of insertion, finding, and deletion all cost a number of operations which is logarithmic in the number of entries currently stored in the tree.

**1.6.1 Proposition** *The algorithm COVECTORSFROMCOCIRCUITS constructs the set of covectors  $\mathcal{F}$  from the set of cocircuits  $\mathcal{D}$  in time  $O(n^2 f_0 |\mathcal{F}|)$ , where  $f_0 = |\mathcal{D}|$  and  $n$  is the cardinality of the ground set  $E$  of the oriented matroid.*

**Proof** The correctness of algorithm COVECTORSFROMCOCIRCUITS is quite obvious. Note that all covectors are added to the set  $\mathcal{F}_{\text{new}}$  exactly once. The complexity analysis uses the trivial fact that  $|\mathcal{F}| \leq 3^n$ , so  $\log_3 |\mathcal{F}| \leq n$ . The **while**-loop is executed for every  $Y$  in  $\mathcal{F}$  once, where every execution costs at most  $O(n^2 f_0)$  as we use a balanced binary tree (i.e., the find and insert operations are both  $O(n \log |\mathcal{F}|)$ , so  $O(n^2)$ ). This leads to an overall complexity of  $O(n^2 f_0 |\mathcal{F}|)$ . ■

For the algorithm TOPESFROMCOCIRCUITS we modify COVECTORSFROMCOCIRCUITS such that only topes are returned. This is easy since  $X \in \mathcal{F}$  is a tope if and only if  $X^0$  is the set of loops (see Lemma 0.7.2).

**1.6.2 Proposition** *The algorithm TOPESFROMCOCIRCUITS constructs the set of topes  $\mathcal{T}$  from the set of cocircuits  $\mathcal{D}$  in time  $O(n^2 f_0 f_d^2)$ , where  $f_0 = |\mathcal{D}|$ ,  $f_d = |\mathcal{T}|$ , and*

*Input:* The ground set  $E$  and the set  $\mathcal{D} \subseteq \{-, +, 0\}^E$  of cocircuits of some oriented matroid.

*Output:* The set  $\mathcal{F} \subseteq \{-, +, 0\}^E$  of covectors of the oriented matroid defined by  $\mathcal{D}$ .

```

begin COVECTORSFROMCOCIRCUITS( $E, \mathcal{D}$ );
   $\mathcal{F} := \{\mathbf{0}\}$ ; ( $\mathcal{F}$  is a balanced binary tree)
   $\mathcal{F}_{\text{new}} := \{\mathbf{0}\}$ ;
  while  $\mathcal{F}_{\text{new}} \neq \emptyset$  do
    take any  $Y$  from  $\mathcal{F}_{\text{new}}$  and remove it from  $\mathcal{F}_{\text{new}}$ ;
    for all  $X \in \mathcal{D}$  do
       $Z := X \circ Y$ ;
      if  $Z \notin \mathcal{F}$  then insert  $Z$  in  $\mathcal{F}$  and add  $Z$  to  $\mathcal{F}_{\text{new}}$  endif
    endfor
  endwhile;
  return  $\mathcal{F}$ 
end COVECTORSFROMCOCIRCUITS.

```

Pseudo-Code 1.4: Algorithm COVECTORSFROMCOCIRCUITS

$n$  is the cardinality of the ground set  $E$  of the oriented matroid. Because of  $f_0 \leq f_d$  (Corollary 1.5.2) the complexity is not higher than  $O(n^2 f_d^3)$ .

**Proof** The proof is similar to the one concerning algorithm COVECTORSFROMCOCIRCUITS. The complexity is again  $O(n^2 f_0 |\mathcal{F}|)$ , which is because of Corollary 1.5.4 at most  $O(n^2 f_0 f_d^2)$ . ■

## 1.7 Algorithmic Characterization of Tope Sets

We consider in this section the characterization problem of tope sets and tope graphs of oriented matroids. We present polynomial algorithms which solve these characterization problems.

**1.7.1 Proposition ([FST91])** *There exists an algorithm which decides whether a given set  $\mathcal{T} \subseteq \{-, +, 0\}^E$  is the set of topes of an oriented matroid or not. The complexity is bounded by  $O(n^3 f_d^2 + n^2 f_d^3)$ , where  $n = |E|$  and  $f_d = |\mathcal{T}|$ .*

**Proof** Consider a set  $\mathcal{T} \subseteq \{-, +, 0\}^E$  of sign vectors. Set  $n := |E|$ . With the face enumeration algorithm FACEENUMERATION from Section 1.5 we can construct in time  $O(n^3 f_d^2)$  a list  $(\mathcal{W}_{-j}, \dots, \mathcal{W}_0)$  such that  $\mathcal{W}_{-j+1}$  is the set of cocircuits corresponding to  $\mathcal{T}$  if  $\mathcal{T}$  is the set of topes of an oriented matroid (cf. Theorem 1.5.7). If the algorithm exceeds the limit of  $f_d^2$  sign vectors then  $\mathcal{T}$  is not the tope set of an oriented matroid: the algorithm stops and reports this. Set  $\mathcal{D} := \mathcal{W}_{-j+1}$ ; if  $|\mathcal{D}| > f_d$  then we stop ( $\mathcal{T}$  is not

```

Input: The ground set  $E$  and the set  $\mathcal{D} \subseteq \{-, +, 0\}^E$  of cocircuits of some
oriented matroid.
Output: The set  $\mathcal{T} \subseteq \{-, +, 0\}^E$  of topes of the oriented matroid defined by  $\mathcal{D}$ .

begin TOPESFROMCOCIRCUITS( $E, \mathcal{D}$ );
  if  $\mathcal{D} = \emptyset$  then return  $\{\mathbf{0}\} = \{0\}^E$ 
  else
     $\mathcal{F} := \{\mathbf{0}\}$ ; ( $\mathcal{F}$  is a balanced binary tree)
     $\mathcal{F}_{\text{new}} := \{\mathbf{0}\}$ ;
     $\mathcal{T} := \emptyset$ ;
     $E^0 := \bigcap_{X \in \mathcal{D}} X^0$ ;
    while  $\mathcal{F}_{\text{new}} \neq \emptyset$  do
      take any  $Y$  from  $\mathcal{F}_{\text{new}}$  and remove it from  $\mathcal{F}_{\text{new}}$ ;
      for all  $X \in \mathcal{D}$  do
         $Z := X \circ Y$ ;
        if  $Z \notin \mathcal{F}$  then
          insert  $Z$  in  $\mathcal{F}$ ;
          if  $Z^0 = E^0$  then add  $Z$  to  $\mathcal{T}$  else add  $Z$  to  $\mathcal{F}_{\text{new}}$  endif
        endif
      endfor
    endwhile;
  return  $\mathcal{T}$ 
endif
end TOPESFROMCOCIRCUITS.

```

Pseudo-Code 1.5: Algorithm TOPESFROMCOCIRCUITS

tope set of an oriented matroid, see Corollary 1.5.2). Otherwise test for  $\mathcal{D}$  the cocircuit axioms in time  $O(n^2|\mathcal{D}|^3)$ , which is at most  $O(n^2 f_d^3)$ . If the cocircuit axioms are valid for  $\mathcal{D}$ , it remains to test whether  $\mathcal{T}$  is the tope set generated from  $\mathcal{D}$  under composition, which can be done in time  $O(n^2 f_d^3)$  using the algorithm TOPESFROMCOCIRCUITS (see Pseudo-Code 1.5 and Proposition 1.6.2). ■

By combination of the result from Proposition 1.7.1 and the algorithm for the orientation reconstruction from Section 1.4, there exists a polynomial algorithm which characterizes tope graphs of oriented matroids. In practice, before this polynomial algorithm is used, the known properties of tope graphs (especially also the new separability property of Corollary 1.3.2) are checked, which reduces the amount of computation considerably.

**1.7.2 Corollary ([FST91])** *Tope graphs of oriented matroids can be characterized in polynomial time: there exists an algorithm which decides for any (connected) graph  $G$  in time bounded by  $O(n^3 f_d^2 + n^2 f_d^3)$  whether  $G$  is the tope graph of an oriented matroid or not, where here  $n = \text{diam}(G)$  and  $f_d = |V(G)|$ .*

**Proof** Consider a graph  $G$ , set  $n := \text{diam}(G)$  and  $f_d := |V(G)|$  (if  $G$  is not connected it is not the tope graph of an oriented matroid). Using algorithm ACYCLOIDORIENTATIONRECONSTRUCTION (see Pseudo-Code 1.1) a set  $\mathcal{T}$  of sign vectors can be constructed in time of at most  $O(n \cdot |V(G)|^3)$  such that  $\mathcal{T}$  is a set of topes if  $G$  is the tope graph of an oriented matroid (cf. Proposition 1.4.1 and note that  $|E(G)| \leq |V(G)|^2$ ; if ACYCLOIDORIENTATIONRECONSTRUCTION fails, e.g., if no antipodal vertex is found,  $G$  was not tope graph of an oriented matroid). By Proposition 1.7.1,  $\mathcal{T}$  can be tested in time  $O(n^3 f_d^2 + n^2 f_d^3)$  for being a set of topes of an oriented matroid, and finally it is obviously possible without increase of the order of complexity to test whether  $G$  is the tope graph of  $\mathcal{T}$ . ■

## Chapter 2

# Cocircuits and Cocircuit Graphs

### 2.1 Introduction and Problem Statements

We discuss in this chapter reconstruction and characterization problems concerning the cocircuit graph of an oriented matroid. The starting point of our work has been an article of Cordovil, Fukuda, and Guedes de Oliveira [CFGdO00] which we obtained as a preprint in 1998, and our goal was to extend their work, mainly by adding algorithmic solutions with complexity analyses to their results. We describe our results in this chapter (see also [BFF01]).

In this section we introduce basic definitions such as cocircuit graphs and graph labels and formulate the problems considered in this chapter. We relate our work to the mentioned work of [CFGdO00] and other related work.

We have introduced graphs in Section 1.1 as pairs  $G = (V(G), E(G))$  of a vertex set  $V(G)$  and an edge set  $E(G)$ , where every edge is represented as an unordered pair of vertices. Again, where appropriate we will identify any two graphs that are isomorphic. The cocircuit graph of an oriented matroid  $\mathcal{M} = (E, \mathcal{D})$  is the 1-skeleton of  $\mathcal{M}$ , which is a graph because of the diamond property of oriented matroids (Theorem 0.7.13): For every covector  $X \in \mathcal{F}$  with  $\text{rank}_{\mathcal{M}}(X) = 2$ , there exist exactly two cocircuits  $V, W \in \mathcal{D}$  such that  $\mathbf{0} \prec V \prec X$  and  $\mathbf{0} \prec W \prec X$ .  $V$  and  $W$  correspond to vertices  $v, w \in V(G)$  and  $X = V \circ W$  to the edge  $\{v, w\} \in E(G)$ . The number of vertices of  $G$  equals the number of cocircuits of  $\mathcal{M}$ , and the number of edges of  $G$  equals the number of 1-dimensional faces of  $\mathcal{M}$ :  $|V(G)| = |\mathcal{D}| = f_0$  and  $|E(G)| = f_1$ . More formally, we define:

**2.1.1 Definition (Cocircuit Graph)** Let  $\mathcal{M} = (E, \mathcal{F})$  be an oriented matroid and  $\mathcal{D}$  the set of cocircuits of  $\mathcal{M}$ . The *cocircuit graph* of  $\mathcal{M}$  is a graph  $G$  with  $f_0 = |\mathcal{D}|$  vertices such that there exists a bijection  $\mathcal{L} : V(G) \rightarrow \mathcal{D}$  for which  $\{v, w\}$  is an edge in  $E(G)$  if and only if, for  $V := \mathcal{L}(v)$  and  $W := \mathcal{L}(w)$ ,  $V \circ W = W \circ V$  (or, equivalently,  $D(V, W) = \emptyset$ ) and  $V$  and  $W$  are the only cocircuits conforming to  $V \circ W$ . We will call a graph a *cocircuit graph* if it is the cocircuit graph of some oriented matroid.

We will call a bijection  $\mathcal{L} : V(G) \rightarrow \mathcal{D}$  like in Definition 2.1.1 an *associating bijection*.

Considering a finite pseudosphere arrangement  $\mathcal{S} = \{S_e \mid e \in E\}$  in the Euclidean space  $\mathbb{R}^{d+1}$  as introduced in Section 0.1 and the corresponding oriented matroid  $\mathcal{M}$ , the cocircuit graph of  $\mathcal{M}$  is the 1-skeleton of the cell complex  $\mathcal{K}$  on  $S^d$  induced by  $\mathcal{S}$ . An illustration of an oriented matroid by a pseudosphere arrangement and the corresponding cocircuit graph is shown in Figure 2.1.

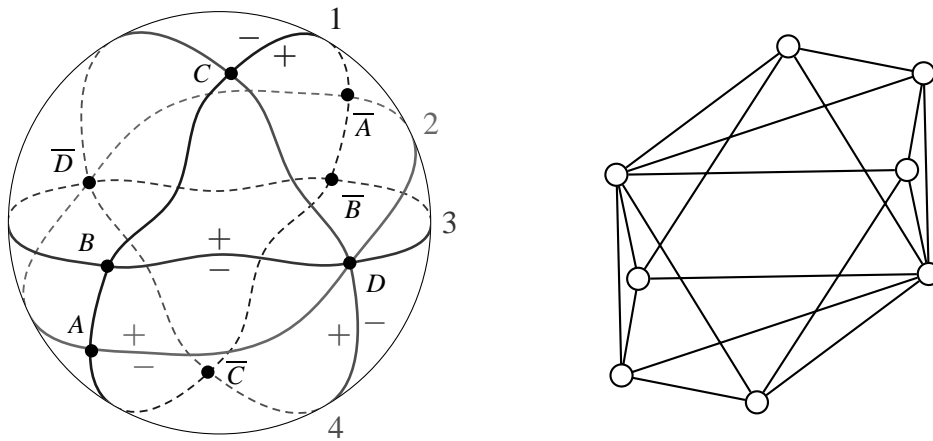

Figure 2.1: Pseudosphere arrangement and cocircuit graph

Compared to the set of covectors  $\mathcal{F}$ , the cocircuit graph is a compact and simple structure (e.g., the number  $f_0$  of cocircuits is not larger than the number  $f_i$  of faces of any other fixed dimension  $i > 0$ , see Theorem 1.5.1). It is a natural to ask, to what extent an oriented matroid is determined by its cocircuit graph, e.g., whether the cocircuit graph of an oriented matroid  $\mathcal{M}$  determines the isomorphism class  $\text{IC}(\mathcal{M})$  of  $\mathcal{M}$ , i.e., (equivalently, see Corollary 1.4.3) the face lattice of  $\mathcal{M}$ . The general answer to the latter question is negative as Cordovil, Fukuda, and Guedes de Oliveira [CFGdO00] presented two non-isomorphic oriented matroids of rank 4 which have isomorphic cocircuit graphs; for rank at most 3 they gave an affirmative answer. However, the question remained open for cocircuit graphs of uniform oriented matroids (which we will simply call *uniform cocircuit graphs*), and positive answers are possible when some information about the oriented matroid is added to the cocircuit graph, as we discuss in the following using the notion of labels.

A *label of a graph  $G$*  (or, short, a *graph label*) is a map  $L$  defined on the vertex set  $V(G)$ , and we call  $L(v)$  the *label of  $v \in V(G)$*  (and, short, a *vertex label*). We will consider the following three types of labels of cocircuit graphs:

**2.1.2 Definition (OM-Label)** For a graph  $G$  and an oriented matroid  $\mathcal{M}$  we call a label  $\mathcal{L}$  of  $G$  the *OM-label (oriented matroid label) of  $G$  w.r.t.  $\mathcal{M}$*  if  $G$  is the cocircuit graph of  $\mathcal{M}$  and every vertex  $v$  is labeled by the cocircuit associated to  $v$ ; we call a label  $\mathcal{L}$  of a graph  $G$  an *OM-label of  $G$*  if  $\mathcal{L}$  is the OM-label of  $G$  w.r.t. some oriented matroid.



Obviously is an oriented matroid explicitly given by its OM-labeled cocircuit graph. If we omit orientations, we obtain a labeling by the underlying matroid:

**2.1.3 Definition (M-Label)** For an OM-label  $\mathcal{L}$  of a graph  $G$  we call a label  $L$  of  $G$  the *M-label (matroid label) of  $G$  induced by  $\mathcal{L}$*  if every vertex  $v$  is labeled by the zero support  $\mathcal{L}(v)^0$ ; we call a label  $L$  of a graph  $G$  an *M-label of  $G$*  if  $L$  is the M-label of  $G$  induced by some OM-label of  $G$ .

The labels of two vertices given by an M-label are the same if and only if they correspond to negative cocircuits; we call such vertices *antipodes* or an *antipodal pair*, and define:

**2.1.4 Definition (AP-Label)** For an M-label  $L$  of a graph  $G$  we call a label  $A$  of  $G$  the *AP-label (antipode label) of  $G$  induced by  $L$*  if every vertex  $v$  is mapped to the *antipode*  $A(v) = \bar{v}$  of  $v$  which is the unique vertex  $\bar{v} \in V(G) \setminus \{v\}$  such that  $L(v) = L(\bar{v})$ ; for a graph  $G$  we call a label of  $G$  an *AP-label of  $G$*  if it is the AP-label of  $G$  induced by some M-label of  $G$ .

We will consider the following reconstruction problems:

**OM-Labeling Problem:** *Given a cocircuit graph  $G$  with M-label  $L$ ,  
find an OM-label  $\mathcal{L}$  of  $G$  such that  $L$  is the M-label of  $G$  induced by  $\mathcal{L}$ .*

**M-Labeling Problem:** *Given a cocircuit graph  $G$  with AP-label  $A$ ,  
find an M-label  $L$  of  $G$  such that  $A$  is the AP-label of  $G$  induced by  $L$ .*

**AP-Labeling Problem:** *Given a cocircuit graph  $G$  (without label),  
find an AP-label of  $G$ .*

We survey in the following the known results concerning these labeling problems, including the results presented in this chapter; see also Figure 2.2 for a corresponding illustration (an arc marked by X indicates that the reconstruction is not possible in general, as the example in [CFGdO00] shows).

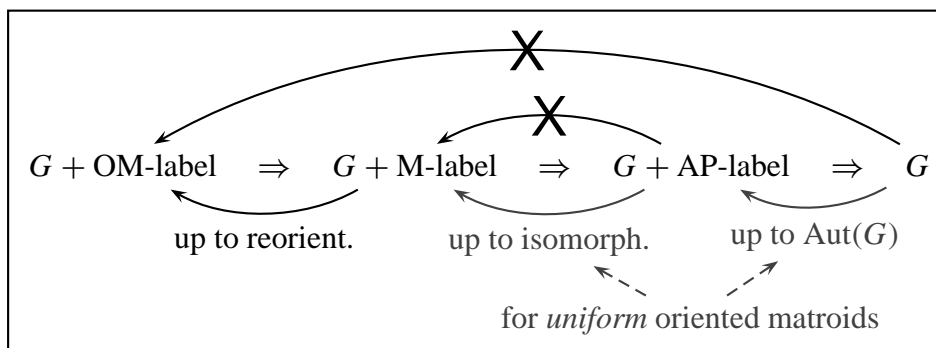

Figure 2.2: Diagram of reconstruction problems and results

The OM-labeling problem has always a solution which is unique up to reorientation, which was proved in [CFGdO00]. We will give a slightly simpler proof in Section 2.2 and

present a simple algorithm for the construction of the OM-label with a running time of  $O((f_0 + f_1)n)$ , where  $n = |E|$  is the cardinality of the ground set. For our complexity analyses we assume that every elementary operation (such as an addition or comparison of single elements) can be computed in constant time.

*The M-labeling problem* has in general no solution which is unique up to isomorphism, as can be seen from the mentioned example in [CFGdO00]. However, if the rank of the oriented matroid is at most 3 or if the oriented matroid is uniform, the M-label is determined (up to isomorphism) by the AP-labeled cocircuit graph, which was also proved in [CFGdO00]. We discuss the uniform case in Section 2.3 and present an algorithm which solves the problem in  $O(f_0 \cdot f_1)$  elementary steps; similar to the proofs in [CFGdO00], we consider in the construction the so-called *coline cycles* of the cocircuit graph and a distance notion defined on the coline cycles.

*The AP-labeling problem* will turn out to be the most difficult of all three problems. We show in Section 2.4 that in the uniform case AP-labels can be reconstructed in polynomial time from the given graph up to graph automorphisms. This implies that the isomorphism class of a uniform oriented matroid  $\mathcal{M}$  is determined by its cocircuit graph. It is still open whether there is a unique AP-label, and also the non-uniform case remains open (except for rank at most 3, which was also discussed in [CFGdO00]).

Strongly related to the reconstruction problems is the question whether and how cocircuit graphs (with or without labels) can be characterized:

**Characterization Problem:** *Decide whether a given graph (without or with label) is a cocircuit graph.*

We discuss in Section 2.5 how the correctness of the input of our algorithms can be checked in polynomial time. This solves the characterization problem for cocircuit graphs of uniform oriented matroids and for M-labeled cocircuit graphs algorithmically (i.e., we do not give a direct graph theoretical characterization). When  $\text{rank}(\mathcal{M}) = 3$ , the cocircuit graph  $G$  of  $\mathcal{M}$  is planar and has a unique dual, which is the tope graph of  $\mathcal{M}$  (cf. Chapter 1); the polynomial characterization of tope graphs for  $\text{rank}(\mathcal{M}) = 3$  [FH93] leads to a polynomial characterization for rank 3 cocircuit graphs.

## 2.2 Orientation Reconstruction from Matroid Label

We consider the OM-labeling problem for a given M-labeled cocircuit graph  $G$  of some oriented matroid  $\mathcal{M}$ . Remark that for oriented matroids of rank 0 or 1 the problem is trivial (cf. Lemma 0.7.14): In rank 0 there is no cocircuit at all, and the cocircuit graph is the empty graph; in rank 1 there are exactly two cocircuits  $Z$  and  $-Z$ , the cocircuit graph consists of two points and no edge. Let us assume in the following that  $\text{rank}(\mathcal{M}) \geq 2$ . Then the ground set  $E$  of  $\mathcal{M}$  is determined by the given M-label  $L$  as the union of all vertex labels  $L(v)$ .

Before we start with the general case, we consider the case of rank 2 which can be characterized easily (see also Figure 2.3):

**2.2.1 Lemma** *A graph  $G$  is the  $M$ -labeled cocircuit graph of an oriented matroid of rank 2 if and only if*

- $G$  is a cycle of even length and
- two distinct vertices  $v, w \in V(G)$  have the same vertex label if and only if  $v$  and  $w$  have maximal distance in  $G$  and
- the intersection of any two different vertex labels is always the same (namely the set of loops).

**Proof** It is not difficult to see that compared to tope graphs the roles of cocircuits and edges interchange, i.e., the vertices in a rank 2 tope graph become the edges in the corresponding cocircuit graph and vice versa. As rank 2 tope graphs are cycles of even length, so are cocircuit graphs of rank 2 oriented matroids. The characterization of oriented matroids of rank 2 in Corollary 1.4.4 implies the remaining claims. ■

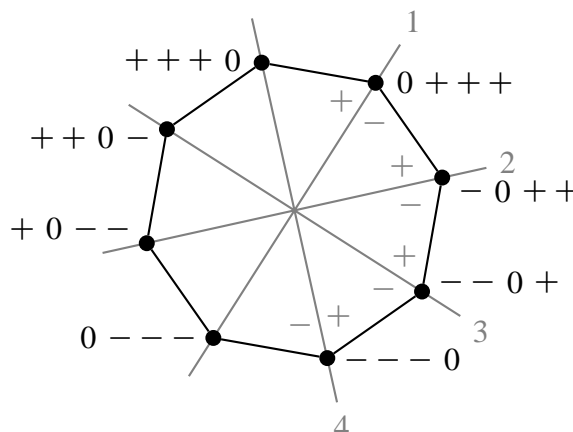

Figure 2.3: Cocircuit graph of an oriented matroid of rank 2

Let  $G$  be the cocircuit graph of an oriented matroid  $\mathcal{M}$ , with associating bijection  $\mathcal{L} : V(G) \rightarrow \mathcal{D}$ . As explained above, an edge  $\{v, w\} \in E(G)$  corresponds to a 1-face  $Z$  of  $\mathcal{M}$  which is determined by  $Z = \mathcal{L}(v) \circ \mathcal{L}(w)$ . The zero support a 1-face is called coline. For example, the coline which corresponds to  $\{v, w\}$  is  $Z^0 = \mathcal{L}(v)^0 \cap \mathcal{L}(w)^0$ .

**2.2.2 Definition (Coline of an Edge)** Let  $G$  be a cocircuit graph of an oriented matroid of rank at least 2 with  $M$ -label  $L$ . For an edge  $\{v, w\} \in E(G)$  we call  $U := L(v) \cap L(w)$  the coline of  $\{v, w\}$  and say that  $\{v, w\}$  corresponds to  $U$ .

**2.2.3 Lemma** *Let  $G$  be the  $M$ -labeled cocircuit graph of an oriented matroid of rank at least 2. The edges in  $G$  which correspond to the same coline form a cycle in  $G$ .*

**Proof** Let  $\mathcal{M}$  be an oriented matroid of rank at least 2,  $G$  the cocircuit graph of  $\mathcal{M}$ , and  $L$  the  $M$ -label of  $G$  w.r.t.  $\mathcal{M}$ . Consider any coline  $U$  and the contraction minor  $\mathcal{M}/U$  to that coline, which is an oriented matroid of rank 2 (cf. Corollary 0.4.6 (ii)). It is not difficult to see that the subgraph in  $G$  induced by the vertices  $v$  with  $U \subseteq L(v)$  is the cocircuit graph of  $\mathcal{M}/U$  (i.e., a cycle of even length, see Lemma 2.2.1) and the edges of this induced subgraph are the edges in  $G$  whose coline is  $U$ . ■

**2.2.4 Definition (Coline Cycle)** Let  $G$  be the  $M$ -labeled cocircuit graph of an oriented matroid of rank at least 2, and let  $U$  be a coline. The cycle  $c(U)$  formed by the edges corresponding to coline  $U$  is called *the coline cycle of  $U$* .

Compared to the work of [CFGdO00] we present a slightly simplified proof for the claim that the reorientation class  $\text{OC}(\mathcal{M})$  is determined by  $G$  and  $L$ , and the proof is directly used for a simple polynomial algorithm `OMLABELFROMMLABEL` that solves the  $OM$ -labeling problem. The key argument is given by the following proposition:

**2.2.5 Proposition** *Let  $\mathcal{L}$  be an  $OM$ -label of  $G$  and  $L$  the  $M$ -label of  $G$  induced by  $\mathcal{L}$ , and for any non-loop  $e \in E$  let  $G(e)$  be the subgraph of  $G$  induced by the vertices  $v$  with  $e \notin L(v)$ . Then there are exactly two connected components of  $G(e)$ , and any two vertices  $v$  and  $w$  belong to the same connected component if and only if  $\mathcal{L}(v)_e = \mathcal{L}(w)_e \neq 0$ .*

A proof of Proposition 2.2.5 was given in [CFGdO00], in the proof of Theorem 2.3. Our proof is based on the same ideas. The following property of hyperplanes in a matroid (see Section 0.3) is needed:

**2.2.6 Lemma** *Let  $(E, \mathcal{A})$  be a matroid of rank  $r \geq 2$  with ground set  $E$  and set  $\mathcal{A}$  of flats and set  $\mathcal{H}$  of hyperplanes. For any two different hyperplanes  $H, \tilde{H} \in \mathcal{H}$  such that  $H \cap \tilde{H}$  is not a coline and any  $e \in E \setminus (H \cup \tilde{H})$  there exists a hyperplane  $H' \in \mathcal{H}$  such that*

- (i)  $e \notin H'$ ,
- (ii)  $H \cap H'$  is a coline, and
- (iii)  $H \cap \tilde{H} \subsetneq H' \cap \tilde{H}$ .

**Proof** Let  $U$  be a coline such that  $H \cap \tilde{H} \subsetneq U \subsetneq H$ , and let  $\tilde{U}$  be the intersection of all hyperplanes containing  $U$  and some  $f \in \tilde{H} \setminus U$ . If  $U \subsetneq \tilde{U}$ , then  $\tilde{U}$  is a hyperplane and every hyperplane containing  $U$  and some  $f \in \tilde{H} \setminus U$  is equal to  $\tilde{U}$ , by this  $U \subseteq \tilde{U} = \tilde{H}$  and  $U \subseteq H \cap \tilde{H}$ , a contradiction. We conclude  $U = \tilde{U}$ , and since  $e \notin U$  there exists a hyperplane  $H'$  containing  $U$  and some  $f \in \tilde{H} \setminus U$  such that  $e \notin H'$ . The claim follows for  $H'$ , observing that  $f \in H' \setminus H$  (remark  $f \notin U \supseteq H \cap \tilde{H}$ , so  $f \notin H$ ) and  $H \cap H' = U$ . ■

**Proof of Proposition 2.2.5** Let  $v$  and  $w$  be vertices in  $G(e)$ . If  $\mathcal{L}(v)_e = -\mathcal{L}(w)_e$ , then the definition of a cocircuit graph implies that on any path in  $G$  from  $v$  to  $w$  there is a vertex  $u$  with  $\mathcal{L}(u)_e = 0$ , i.e.,  $v$  and  $w$  are not connected in  $G(e)$ . Let us assume  $\mathcal{L}(v)_e = \mathcal{L}(w)_e \neq 0$ . The claim follows when we show that  $v$  and  $w$  are connected in  $G(e)$ . If  $L(v) = L(w)$  then by cocircuit axiom (C2)  $v = w$ , otherwise we apply

(possibly repeatedly) Lemma 2.2.6: There exists a finite sequence of hyperplanes  $L(v) := H_0, H_1, \dots, H_k := L(w)$  such that  $e \notin H_i$  for all  $i \in \{0, \dots, k\}$  and  $U_i := H_{i-1} \cap H_i$  is a coline for all  $i \in \{1, \dots, k\}$ . By cocircuit axiom (C2), there exists for every  $i \in \{0, \dots, k\}$  a unique vertex  $v_i$  such that  $L(v_i) = H_i$  and  $\mathcal{L}(v_i)_e = \mathcal{L}(v)_e$ . We show that for all  $i \in \{1, \dots, k\}$  the vertices  $v_{i-1}$  and  $v_i$  are connected in  $G(e)$ : Both  $v_{i-1}$  and  $v_i$  are on the coline cycle  $c(U_i)$  of  $U_i$  in  $G$ , and since  $\mathcal{L}(v_{i-1})_e = \mathcal{L}(v_i)_e$  there is a (unique) path on  $c(U_i)$  from  $v_{i-1}$  to  $v_i$  in  $G(e)$ . ■

The property of an M-labeled cocircuit graph  $G$  which is stated in Proposition 2.2.5 leads directly to a simple algorithm which solves the OM-labeling problem for rank at least 2: For every element  $e \in E$  determine the two connected components of the subgraph  $G(e)$  of  $G$  induced by the vertices  $v$  with  $e \notin L(v)$ , and assign a + sign to all vertices in one component, a – sign to the vertices in the other component, 0 to the remaining vertices. A more formal description of this algorithm OMLABELFROMMLABEL is given by Pseudo-Code 2.1.

*Input:* A cocircuit graph  $G$  with M-label  $L$ .  
*Output:* An OM-label  $\mathcal{L}$  of  $G$  such that  $L$  is the M-label of  $G$  induced by  $\mathcal{L}$ .

```

begin OMLABELFROMMLABEL( $G, L$ );
   $E := \bigcup_{v \in V(G)} L(v)$ ;
  for all  $e \in E$  do
     $G(e) :=$  the subgraph of  $G$  induced by  $\{v \in V(G) \mid e \notin L(v)\}$ ;
    if  $G(e)$  is empty then
      for all  $v \in V(G)$  do  $\mathcal{L}(v)_e := 0$  endfor
    else
      let  $w$  be any vertex in  $G(e)$ ;
      for all  $v \in V(G)$  do

$$\mathcal{L}(v)_e := \begin{cases} 0 & \text{if } e \in L(v), \\ + & \text{if } e \notin L(v) \text{ and } v \text{ is connected to } w \text{ in } G(e), \\ - & \text{otherwise.} \end{cases}$$

      endfor
    endif
  endfor;
  return  $\mathcal{L}$ 
end OMLABELFROMMLABEL.

```

Pseudo-Code 2.1: Algorithm OMLABELFROMMLABEL

**2.2.7 Theorem** *Given as input a cocircuit graph  $G$  with M-label  $L$ , then the algorithm OMLABELFROMMLABEL terminates with correct output after at most  $O((f_0 + f_1)n)$  elementary arithmetic operations, where  $f_0 = |V(G)|$ ,  $f_1 = |E(G)|$ ,  $n = |E|$ . The orientation is unique up to reorientation.*

**Proof** The correctness of the algorithm OMLABELFROMMLABEL and the uniqueness of the OM-label up to reorientation follow from Proposition 2.2.5. For the complexity observe that for every of the  $n$  elements in  $E$  the induced subgraph  $G(e)$  and its connected components can be computed in  $O(f_0 + f_1)$  (e.g., by a breadth-first-search technique). ■

**2.2.8 Corollary ([CFGdO00])** *The reorientation class of an oriented matroid is determined by its M-labeled cocircuit graph.*

## 2.3 Reconstruction of Uniform Matroid Labels from Antipodes

We discuss in this section the M-labeling problem where the given graph  $G$  is the cocircuit graph of some uniform oriented matroid and where an AP-label  $A$  of  $G$  is given. Without loss of generality our concern will be to find an M-label of  $G$  which is induced by a uniform oriented matroid. Note that for oriented matroids of rank 0 or 1 the M-labeling problem is trivial, and we can assume for the following that  $\text{rank}(\mathcal{M}) \geq 2$ . We present a polynomial algorithm MLABELFROMAPLABEL which computes an M-label  $L$  of  $G$  such that  $A$  is the AP-label of  $G$  induced by  $L$ . By this we extend the result of [CFGdO00] which states that such an M-label is unique up to isomorphism on the ground set, which is the union of the vertex labels. Note that for the algorithm MLABELFROMAPLABEL no information like  $\mathcal{M}$ ,  $E$ , or  $\text{rank}(\mathcal{M})$  is given; we will only use  $G$ , the given AP-labeling  $A : v \mapsto \bar{v}$ , and the information that  $\mathcal{M}$  is uniform. This uniformity implies many structural properties:

**2.3.1 Lemma** *Let  $\mathcal{M} = (E, \mathcal{F})$  be a uniform oriented matroid with  $n := |E|$  and  $r := \text{rank}(\mathcal{M}) \geq 2$ . Then:*

- (i) *Every subset of  $r - 1$  elements is a hyperplane, and every subset of  $r - 2$  elements is a coline.*
- (ii) *All coline cycles have length  $2 \cdot (n - r + 2)$ .*
- (iii) *The coline cycles of any two different colines  $U_1$  and  $U_2$  have a common vertex if and only if  $|U_1 \setminus U_2| = 1$ .*

**Proof** The claims follow quite directly from the uniformity of  $\mathcal{M}$ . Observe that a vertex  $v$  is on the cycle of a coline  $U$  if and only if the hyperplane associated to  $v$  has the form  $U \cup \{e\}$  for some  $e \in E \setminus U$ . ■

**2.3.2 Definition (Distance of Coline Cycles)** Let  $\mathcal{M} = (E, \mathcal{F})$  be a uniform oriented matroid,  $G$  its cocircuit graph with OM-label  $\mathcal{L}$ ,  $L$  the M-label of  $G$  induced by  $\mathcal{L}$ , and  $v_0 \in V(G)$  an arbitrary vertex. For a coline  $U \subseteq E$  we call  $|U \setminus L(v_0)|$  the distance of  $U$  to  $v_0$  and also the distance of the coline cycle of  $U$  to  $v_0$ .

The distance of a coline cycle is also defined by the cocircuit graph and the coline cycles (i.e., without hyperplanes and colines):

**2.3.3 Corollary ([CFGdO00])** *The coline cycles of distance 0 to  $v_0$  are the coline cycles through  $v_0$ , the coline cycles of distance 1 are those which intersect a coline cycle of distance 0 but do not meet  $v_0$ ; inductively the coline cycles of distance  $k + 1$  are exactly those that intersect at least one coline cycle of distance  $k$  but which are not of distance  $k$ .*

The following lemma states an important property of coline cycles:

**2.3.4 Lemma ([CFGdO00])** *Let  $\mathcal{M} = (E, \mathcal{F})$  be a uniform oriented matroid,  $n := |E|$ , and  $r := \text{rank}(\mathcal{M}) \geq 2$ . Let  $p$  be a path  $v = v_0, v_1, v_2, \dots, v_{t-1}, v_t = \bar{v}$  in the cocircuit graph  $G$  of  $\mathcal{M}$  connecting an antipodal pair  $(v, \bar{v})$ . Then  $p$  is a shortest path in  $G$  from  $v$  to  $\bar{v}$  if and only if  $t = n - r + 2$ , and then there exists a coline  $U \subseteq E$  such that  $\{v_{i-1}, v_i\}$  is an edge on the coline cycle of  $U$  for all  $i \in \{1, \dots, t\}$ .*

**Proof** Let  $L$  be the M-label induced by the OM-label of  $G$  w.r.t.  $\mathcal{M}$ . Obviously there are  $2 \cdot (r - 1)$  different paths from  $v$  to  $\bar{v}$  of length  $n - r + 2$  that are defined by the  $r - 1$  coline cycles through  $v$  and  $\bar{v}$ . On the other hand, let  $p$  be a path from  $v$  to  $\bar{v}$ , and let  $J \subseteq E$  be the set of elements that belong to some but not all labels of the vertices  $v_i$  on  $p$ . Since by uniformity  $|L(v_{i-1}) \setminus L(v_i)| = 1$  for each edge  $\{v_{i-1}, v_i\}$  on  $p$ ,  $L(v) = L(\bar{v})$  implies that the cardinality  $|J|$  is a lower bound for the length of  $p$ . Certainly  $E \setminus L(v) \subseteq J$ , and if  $p$  does not follow only one coline, then  $|L(v) \cap J| \geq 2$ , i.e., then the length of  $p$  is at least  $|E \setminus L(v)| + 2 = n - r + 3$ . ■

The algorithmic idea is first to detect the coline cycles of the cocircuit graph with an algorithm LISTCOLINECYCLES with input and output as specified in Pseudo-Code 2.2, and then to use these coline cycles to construct an M-label with an algorithm MLABELFROMCOLINECYCLES (see Pseudo-Code 2.3); the two steps could be done in parallel, but for clarity and since there is no loss w.r.t. complexity we present the algorithm MLABELFROMAPLABEL divided into this two parts (cf. Pseudo-Code 2.4).

*Input:* A cocircuit graph  $G$  with AP-label  $A$ , and  $v_0 \in V(G)$ .  
*Output:* A list  $S$  of all coline cycles of  $G$  such that every coline cycle  $c \in S$  is given as a list of the vertices on  $c$  in an order as they are adjacent on  $c$ , and such that  $S$  is ordered with increasing coline distance to vertex  $v_0$ , and among the coline cycles of distance 1 those come first which intersect the first coline cycle in  $S$ .

Pseudo-Code 2.2: Input and Output Specification of LISTCOLINECYCLES

*Input:* A list  $S$  as specified as output of LISTCOLINECYCLES.  
*Output:* An M-label  $L$  of the graph  $G$  given by  $S$ .

Pseudo-Code 2.3: Input and Output Specification of MLABELFROMCOLINECYCLES

It is not difficult to design an algorithm LISTCOLINECYCLES as specified in Pseudo-Code 2.2 which runs in time of at most  $O(f_0 f_1)$ , where as before  $f_0 = |V(G)|$  and

*Input:* A cocircuit graph  $G$  with AP-label  $A$ .

*Output:* An M-label  $L$  of  $G$  such that  $A$  is the AP-label of  $G$  induced by  $L$ .

```

begin MLABELFROMAPLABEL( $G, A$ );
  Choose any vertex  $v_0 \in V(G)$ ;
   $S :=$  LISTCOLINECYCLES( $G, A, v_0$ );
  return MLABELFROMCOLINECYCLES( $S$ )
end MLABELFROMAPLABEL.

```

Pseudo-Code 2.4: Algorithm MLABELFROMAPLABEL

$f_1 = |E(G)|$ : it is sufficient to visit all antipodal pairs with increasing coline distance to  $v_0$ , to determine for each pair  $(v, \bar{v})$  the  $2(r - 1)$  shortest paths between  $v$  and  $\bar{v}$ , and to combine two such paths to a coline cycle when they contain antipodal vertices (cf. Lemma 2.3.4).

The key ideas of algorithm MLABELFROMCOLINECYCLES are an initialization of the labels as far as the freedom of isomorphism allows, and then the propagation of the labels observing necessary conditions; finally the coline cycle connectivity will be used to prove that the construction of the M-label has been complete. The necessary conditions for propagation and the coline cycle connectivity are stated in the following lemma:

**2.3.5 Lemma** *Consider the cocircuit graph  $G$  of a uniform oriented matroid, an M-label  $L$  of  $G$ , and the coline cycles in  $G$  given by  $L$ .*

- (i) *If  $v$  and  $w$  are vertices on a common coline cycle  $c$  and not antipodals, then the intersection  $L(c)$  of all labels of vertices on  $c$  is equal to  $L(v) \cap L(w)$ .*
- (ii) *If  $v$  is a vertex on two different coline cycles  $c_1, c_2$ , then  $L(v) = L(c_1) \cup L(c_2)$ .*
- (iii) *On a coline cycle of distance  $k \geq 1$  to  $v_0$  there are exactly  $2 \cdot (k + 1)$  vertices that are on at least one coline cycle of distance  $k - 1$ ; every of these vertices is on exactly  $k$  coline cycles of distance  $k - 1$ .*

**Proof** All claims follow from the definition of an M-label and the uniformity of  $\mathcal{M}$ ; see also Lemma 2.3.1. ■

For an M-label  $L$ , we call for a coline cycle  $c$  the set  $L(c)$  as introduced in Lemma 2.3.5 *the label of  $c$* . We discuss now initialization and propagation of the labels in the construction of an M-label by algorithm MLABELFROMCOLINECYCLES. Consider a set  $S$  as returned by algorithm LISTCOLINECYCLES.

**Initialization.** We can easily determine  $r := \text{rank}(\mathcal{M})$  and  $n := |E|$  from  $S$ , since every vertex appears on exactly  $r - 1$  coline cycles and every coline cycle has length  $2 \cdot (n - r + 2)$ . Using the freedom of isomorphism we initialize  $L(v_0) := \{1, \dots, r - 1\}$ , and of course  $L(\bar{v}_0) := L(v_0)$ , and the labels of the remaining  $2 \cdot (n - r + 1)$  vertices on the first coline cycle in  $S$  are set to  $\{1, \dots, r - 2\} \cup \{j\}$  for  $j \in \{r, \dots, n\}$ , where antipodal vertices take



the same label. Hence the label of the first coline cycle in  $S$  is set to  $\{1, \dots, r - 2\}$ ; we are still free to initialize the labels of the remaining coline cycles  $c_i$  of distance 0 (i.e., the coline cycles at a position  $i \in \{2, \dots, r - 1\}$  in  $S$ ) by  $L(c_i) := \{1, \dots, r - 1\} \setminus \{i - 1\}$  (i.e., we initialize the label of every vertex  $v$  on  $c_i$  that is different from  $v_0$  and  $\overline{v_0}$  by  $L(v) := L(c_i)$ ).

**Propagation.** In the order of list  $S$ , i.e., with increasing distance to vertex  $v_0$ , and starting with the first coline cycle of distance 1 (this coline cycle is at position  $r$  in  $S$ ) we do the following for every coline cycle  $c$ :

1. We determine the label  $L(c)$  as follows:
  - If  $c$  is of distance 1 and intersects the first coline cycle in  $S$ , the only two distinct labels already initialized on  $c$  have the form  $\{1, \dots, r - 2\} \cup \{j\}$  for  $j \in \{r, \dots, n\}$  and  $L(c_i) = \{1, \dots, r - 1\} \setminus \{i - 1\}$  for  $i \in \{2, \dots, r - 1\}$ ; the label must then be  $L(c) := \{1, \dots, r - 2\} \setminus \{i - 1\} \cup \{j\}$ .
  - If  $c$  is of distance 1 and does not intersect the first coline cycle in  $S$ , then there are two distinct labels already initialized on the coline cycle  $c$  which have the form  $\{1, \dots, r - 1\} \setminus \{i_1 - 1\} \cup \{j\}$  and  $\{1, \dots, r - 1\} \setminus \{i_2 - 1\} \cup \{j\}$  for  $i_1, i_2 \in \{2, \dots, r - 1\}$  with  $i_1 \neq i_2$  and  $j \in \{r, \dots, n\}$ ; the label must then be their intersection, i.e.,  $L(c) := \{1, \dots, r - 1\} \setminus \{i_1 - 1\} \setminus \{i_2 - 1\} \cup \{j\}$ .
  - If  $c$  is of distance  $k \geq 2$ , then we choose any two among the  $k + 1$  labels already initialized on  $c$ ; these labels are already determined by  $k \geq 2$  vertices of distance  $k - 1$ , hence  $L(c)$  is equal to the intersection of these two labels.
2. We add  $L(c)$  to  $L(v)$  for every vertex  $v$  on the coline cycle:  $L(v) := L(v) \cup L(c)$ ; for the first time we set  $L(v) := L(c)$ , and after the next change will  $L(v)$  be a  $(r - 1)$ -subset of  $E$ , i.e.,  $L(v)$  is then a complete vertex label and will not be changed further.

Initialization and propagation describe the algorithm `MLABELFROMCOLINECYCLES`, hence also the algorithm `MLABELFROMAPLABEL` is now complete (see Pseudo-Code 2.4).

**2.3.6 Theorem** *If  $G$  is the cocircuit graph of a uniform oriented matroid  $\mathcal{M}$  with  $\text{rank}(\mathcal{M}) \geq 2$  and  $A$  an AP-label of  $G$ , then the algorithm `MLABELFROMAPLABEL` terminates with correct output in time  $O(f_0 f_1)$ , where  $f_0 = |V(G)|$  and  $f_1 = |E(G)|$ . The  $M$ -label  $L$  constructed by `MLABELFROMAPLABEL` is unique up to isomorphism on the ground set.*

**Proof** Let  $\mathcal{M} = (E, \mathcal{D})$  be a uniform oriented matroid,  $n := |E|$ ,  $r := \text{rank}(\mathcal{M}) \geq 2$ ; in addition we set  $u := \binom{n}{r-2}$  for the number of colines and denote by  $G$  the cocircuit graph of  $\mathcal{M}$ . We have already seen that with input  $G$  and  $A$  the algorithm determines all labels correctly and—up to isomorphism—uniquely because of the properties stated in Lemma 2.3.5 (note that in the special case  $\text{rank}(\mathcal{M}) = 2$ , the labels are complete after initialization of the first coline cycle). The complexity of `LISTCOLINECYCLES` was

stated to be  $O(f_0 f_1)$ , and we will show that the complexity of MLABELFROMCOLINECYCLES is of order  $O(f_1) + O(r \cdot u)$ , which is also at most  $O(f_0 f_1)$  because  $n \geq r$  implies  $f_0 = 2 \binom{n}{r-1} \geq 2 \binom{r}{r-1} = 2r$  and  $f_1 = 2u(n - r + 2) \geq 4u$ , hence  $f_0 f_1 \geq 8ru$ . In MLABELFROMCOLINECYCLES we visit every vertex in every coline cycle not more than some constant number of times (from there  $O(f_1)$  operations). We modify the label of every vertex at most twice, and since we can keep labels sorted we need  $O(r)$  operations for one modification, which leads to a total number of  $O(f_0 r) = O(f_1)$  operations for all label modifications. Finally we need for every of the  $u$  coline cycles  $O(r)$  computations to find its label. ■

## 2.4 Antipodes in Uniform Cocircuit Graphs

In this section we discuss how to solve the M-labeling problem for a cocircuit graph  $G$  of a uniform  $\mathcal{M}$  without AP-label, by this strengthening the result of the previous section. Again we will not consider M-labels that are not induced by a uniform oriented matroid. We first discuss how to construct an M-label when the labels of only two antipodal pairs on a common coline are given:

**2.4.1 Theorem** *If  $G$  is the cocircuit graph of a uniform oriented matroid  $\mathcal{M}$  and there are two different antipodal pairs labeled in  $G$  which are known to be on a common coline cycle, then one can construct an M-label  $L$  of  $G$  in time  $O(f_0 f_1)$ , where  $f_0 = |V(G)|$  and  $f_1 = |E(G)|$ , and the AP-label of  $G$  induced by  $L$  is uniquely determined by  $G$  and the two given antipodal pairs.*

**Proof** Let  $v, \bar{v}$  and  $w, \bar{w}$  be two different antipodal pairs in  $G$  that are on a common coline cycle  $c$ . As for the label construction in the previous section,  $r := \text{rank}(\mathcal{M})$  and the cardinality  $n$  of the ground set of  $\mathcal{M}$  can be easily found from the degree  $2 \cdot (r - 1)$  of a vertex and the distance  $n - r + 2$  of an antipodal pair. Let  $E$  be a set of cardinality  $n$ . We know that for any M-label  $L$  of  $G$  with ground set  $E$  the vertex labels  $L(v) = L(\bar{v})$  and  $L(w) = L(\bar{w})$  are  $(r - 1)$ -subsets of  $E$  and  $L(c) = L(v) \cap L(w)$  is an  $(r - 2)$ -subset of  $E$ , hence  $L(v) = L(c) \cup \{e_v\}$  and  $L(w) = L(c) \cup \{e_w\}$  for  $e_v, e_w \in E \setminus L(c)$ , where  $e_v \neq e_w$ . There are  $2 \cdot (r - 1)$  shortest paths between  $v$  and  $\bar{v}$ , each corresponding to one half of a coline cycle (see Lemma 2.3.4), and the same holds for  $w$  and  $\bar{w}$ ; we have to detect which paths belong to the same coline cycle. It is easy to find the shortest paths belonging to the coline cycle  $c$  which contains the given antipodal pairs. Two shortest paths not belonging to  $c$ , say  $p_1$  between  $v$  and  $\bar{v}$  and  $p_2$  between  $w$  and  $\bar{w}$ , belong to coline cycles  $c_1$  and  $c_2$  with labels  $L(c_1) = L(v) \setminus \{e_1\}$  and  $L(c_2) = L(w) \setminus \{e_2\}$  for some  $e_1, e_2 \in L(c)$ , and since  $L(c_1) \setminus L(c_2) = \{e_v, e_2\} \setminus \{e_1\}$ , the paths  $p_1$  and  $p_2$  have a common vertex (an *intersection vertex*) if and only if  $e_1 = e_2$  (cf. Lemma 2.3.1 (iii)); the label of the intersection vertex is  $L(c) \cup \{e_v, e_w\} \setminus \{e_1\}$ . It is easy to see that there are exactly  $2 \cdot (r - 2)$  intersection vertices (namely  $r - 2$  antipodal pairs) with labels  $L(c) \cup \{e_v, e_w\} \setminus \{e_i\}$  for  $e_i \in L(c)$ , and hence any two intersection vertices are on a common coline cycle with a label of the form  $L(c) \cup \{e_v, e_w\} \setminus \{e_i, e_j\}$ . Therefore the distance of two intersection vertices in  $G$  is less or equal to  $n - r + 2$  with equality if and only if they are antipodals; by this we can identify shortest paths belonging to the same coline cycle. Hence we can

determine all coline cycles of distance 0 to  $v$  and with the same technique for the rest of  $G$ , extending the labeling as in the algorithm `MLABELFROMCOLINECYCLES`. Also the complexity discussion is similar to the discussion above, it is sufficient to count all costs for computing shortest paths and identifying antipodal intersection vertices correctly (for every of the  $f_0$  vertices there are total costs of  $O(f_1)$ ). ■

Theorem 2.4.1 implies:

**2.4.2 Corollary** *There is an algorithm which solves the M-labeling problem for a given cocircuit graph  $G$  of a uniform oriented matroid  $\mathcal{M} = (E, \mathcal{D})$  without AP-label in time  $O(f_0^3 f_1 n^2)$ , where  $f_0 = |V(G)|$ ,  $f_1 = |E(G)|$ ,  $n = |E|$ .*

**Proof** For a choice of two pairs of vertices  $(v, \bar{v})$  and  $(w, \bar{w})$  from  $G$ , we construct a label  $L$  of  $G$  as in the proof of Theorem 2.4.1 (this might fail, then  $(v, \bar{v})$  and  $(w, \bar{w})$  are not two antipodal pairs); if  $L$  is an M-label of  $G$  (we can check this in time  $O(f_0^3 n^2)$ , see Theorem 2.5.1), we stop, otherwise  $(v, \bar{v})$  and  $(w, \bar{w})$  are not two antipodal pairs and we start over with other pairs. Obviously it is sufficient to check pairs where  $\{v, w\}$  and  $\{\bar{v}, \bar{w}\}$  are edges in  $G$  and one edge is fix, i.e., there are at most  $O(f_1)$  pairs to check. ■

It remains to discuss whether the M-labels of a graph  $G$  that is the cocircuit graph of a uniform oriented matroid are all isomorphic, i.e., whether for any two M-labels  $L : V(G) \rightarrow 2^E$  and  $\tilde{L} : V(G) \rightarrow 2^{\tilde{E}}$  there exists a bijection  $\phi : E \rightarrow \tilde{E}$  such that  $\tilde{L} = \phi L$ . We will prove this up to graph automorphism in Theorem 2.4.4, using Theorem 2.4.1 and the following Lemma 2.4.3:

**2.4.3 Lemma** *Let  $G$  be the cocircuit graph of a uniform oriented matroid  $\mathcal{M} = (E, \mathcal{D})$  with  $\text{rank}(\mathcal{M}) = 2$  or  $\text{rank}(\mathcal{M}) = 3$ , and  $v, w \in V(G)$ . The distance from  $v$  to  $w$  in  $G$  is at most  $|E| - \text{rank}(\mathcal{M}) + 2$  with equality if and only if  $v$  and  $w$  are antipodals.*

**Proof** Let  $\mathcal{L}$  be an OM-label of  $G$  w.r.t.  $\mathcal{M}$ , and set  $V := \mathcal{L}(v)$  and  $W := \mathcal{L}(w)$ . We assume that  $V$  and  $W$  are not on a common coline and therefore  $\text{rank}(\mathcal{M}) = 3$ , otherwise the claim is obviously correct. Without loss of generality we assume that  $E = \{1, \dots, n\}$ ,  $V^0 = \{1, 2\}$ ,  $3 \in W^0$ , and  $W_1 = W_2 = V_3 = +$ . We consider for  $i \in I := \{1, 2, 3\}$  the colines  $\{i\}$  and their coline cycles  $c_i$ . For  $i \in I$  let  $X^i$  be the cocircuit defined by  $X^i_i = +$  and  $X^i_j = 0$  for  $j \in I \setminus \{i\}$ , then the vertex  $x_i$  corresponding to  $X^i$  is on the intersection of  $c_j$  and  $c_k$  for  $\{j, k\} = I \setminus \{i\}$  (especially  $v = x_3$ ). Denote by  $p_i$  the shorter of the two paths on  $c_i$  between  $x_j$  and  $x_k$ , where  $\{j, k\} = I \setminus \{i\}$ . Then the union  $p$  of the paths  $p_1, p_2, p_3$  forms a cycle in  $G$ , and a vertex  $y \in V(G)$  is on  $p$  if and only if  $\mathcal{L}(y)_I \in \{0, +\}^I \setminus (\{0\}^I \cup \{+\}^I)$ . As  $v$  and  $w$  are on  $p$ , it is sufficient to prove that the length of  $p$  is less than  $2(n - 1)$ . We show that there are at most  $2(n - 3)$  vertices  $y$  on  $p$  different from  $x_1, x_2$ , and  $x_3$ : Such a vertex  $y$  is characterized by  $\mathcal{L}(y)_e = 0$  for some  $e \in E \setminus I$  and  $\mathcal{L}(y)_i = 0$  for some  $i \in I$ , and then  $\mathcal{L}(y)_j = +$ ,  $\mathcal{L}(y)_k = +$  for  $\{j, k\} = I \setminus \{i\}$ . Assume that for some  $e \in E \setminus I$  there exist all three vertices, i.e., there exist three cocircuits in  $\mathcal{D}$  whose signs corresponding to 1, 2, 3,  $e$  are  $(0 \ + \ + \ 0)$ ,  $(+ \ 0 \ + \ 0)$ , and  $(+ \ + \ 0 \ 0)$ ; then the cocircuit axiom (C3) applied to the first and the negative of the second implies a contradiction to axiom (C2) for the third cocircuit. Therefore there exist for every  $e \in E \setminus I$  at most two vertices  $y$  on  $p$  with  $\mathcal{L}(y)_e = 0$ . ■

The following theorem is based on an idea of Babson [BFF01]. We denote by  $\rho\sigma$  ( $\rho$  after  $\sigma$ ) the concatenation of maps  $\rho, \sigma$  and by  $\tau^{-1}$  the inverse of a bijection  $\tau$ .

**2.4.4 Theorem** *Let  $G$  be the cocircuit graph of a uniform oriented matroid  $\mathcal{M}$  and  $L$  and  $\tilde{L}$   $M$ -labels of  $G$ . Then there exists a graph automorphism  $g \in \text{Aut}(G)$  such that  $Lg$  and  $\tilde{L}$  are isomorphic, i.e.,  $\pi Lg = \tilde{L}$  for some permutation  $\pi$ .*

**Proof** Let  $L$  and  $\tilde{L}$  be  $M$ -labels of  $G$ , and denote the induced AP-labels by  $A$  and  $\tilde{A}$ , respectively. Remark that  $A^{-1} = A \in \text{Aut}(G)$  and  $\tilde{A}^{-1} = \tilde{A} \in \text{Aut}(G)$ . Since for any  $g \in \text{Aut}(G)$  the AP-label induced by  $Lg$  is  $g^{-1}Ag$  and because of Theorem 2.3.6, it is sufficient to find  $g \in \text{Aut}(G)$  such that  $g^{-1}Ag = \tilde{A}$ . As  $\text{Aut}(G)$  is finite, the order of  $\tilde{A}A \in \text{Aut}(G)$  is finite. If the order of  $\tilde{A}A$  is odd, say  $2k + 1$  for a nonnegative integer  $k$ , then  $g := (\tilde{A}A)^k$  is sufficient. We will show that the order of  $\tilde{A}A$  cannot be even.

We show that  $(\tilde{A}A)^2 = 1$  implies  $\tilde{A}A = 1$  (hence the order of  $\tilde{A}A$  cannot be 2). Let  $E$  denote the ground set of  $L$ , and as usual  $n := |E|$  and  $r := \text{rank}(\mathcal{M})$ . Assume  $(\tilde{A}A)^2 = 1$ , then the AP-labels induced by  $L\tilde{A}$  and  $L$  are equal, so, by Theorem 2.3.6,  $L\tilde{A}$  and  $L$  are isomorphic, i.e., there exists a permutation  $\pi$  of the elements in  $E$  such that  $\pi L = L\tilde{A}$ . As  $\pi\pi L = \pi L\tilde{A} = L\tilde{A}\tilde{A} = L$  implies  $\pi^2 = 1$ , the orbits of  $\pi$  must all have order 1 or 2, so we can choose a union  $U \subseteq E$  of these orbits with  $|U| = r - 2$  or  $|U| = r - 3$ . Consider the subgraph  $G_U$  of  $G$  induced by the vertex set  $V(G_U) := \{v \in V(G) \mid U \subseteq L(v)\}$ . Remark that  $V(G_U)$  is closed under  $A$  by definition and also closed under  $\tilde{A}$  because of  $L\tilde{A} = \pi L$  and  $\pi(U) = U$ .  $G_U$  is the cocircuit graph of a uniform oriented matroid contraction minor with rank  $r' := r - |U| \in \{2, 3\}$  and  $n' := n - |U|$  elements in the ground set, so Lemma 2.4.3 implies that for every vertex  $v \in V(G_U)$  there is a unique vertex  $\bar{v} \in V(G_U)$  such that the distance in  $G_U$  from  $v$  to  $\bar{v}$  is at least  $n' - r' + 2 = n - r + 2$ . On the other hand  $n - r + 2$  is the distance in  $G$  between a vertex  $v$  and  $A(v)$  (and also between  $v$  and  $\tilde{A}(v)$ ), and the distance in the subgraph  $G_U$  cannot be smaller. Therefore  $A(v) = \tilde{A}(v) = \bar{v}$  for  $v \in V(G_U)$ , so, by Theorem 2.4.1,  $A = \tilde{A}$ .

Assume that the order of  $\tilde{A}A$  is  $2k$  for an integer  $k > 1$ . If  $k = 2k'$  set  $\hat{L} := L(\tilde{A}A)^{k'-1}\tilde{A}$ , if  $k = 2k' + 1$  set  $\hat{L} := \tilde{L}(A\tilde{A})^{k'}$ . Let  $\hat{A}$  denote the AP-label induced by the  $M$ -label  $\hat{L}$ , then in either case  $\hat{A}A = (\tilde{A}A)^k$ , hence  $(\hat{A}A)^2 = 1$ . Thus by the previous case  $(\tilde{A}A)^k = \hat{A}A = 1$ , contradicting the assumption that the order of  $\tilde{A}A$  is  $2k$ . ■

**2.4.5 Corollary** *The isomorphism class of a uniform oriented matroid is determined by its cocircuit graph.*

**Proof** The proof follows from Corollary 2.2.8 and Theorem 2.4.4. Let  $\mathcal{M}$  and  $\tilde{\mathcal{M}}$  be two uniform oriented matroids which both have the same cocircuit graph, i.e., there exists a graph isomorphism  $\phi : \tilde{G} \rightarrow G$  between the cocircuit graph  $\tilde{G}$  of  $\tilde{\mathcal{M}}$  and the cocircuit graph  $G$  of  $\mathcal{M}$ . Let  $\mathcal{L}$  and  $\tilde{\mathcal{L}}$  denote OM-labels of  $G$  and  $\tilde{G}$  w.r.t.  $\mathcal{M}$  and  $\tilde{\mathcal{M}}$  and  $L$  and  $\tilde{L}$  the  $M$ -labels induced by  $\mathcal{L}$  and  $\tilde{\mathcal{L}}$ , respectively. By Theorem 2.4.4 there exists  $g \in \text{Aut}(G)$  such that  $Lg$  and  $\tilde{L}\phi$  are isomorphic. Then Corollary 2.2.8 implies that  $\mathcal{L}g$  and  $\tilde{\mathcal{L}}\phi$  are isomorphic, which is equivalent to say that  $\mathcal{M}$  and  $\tilde{\mathcal{M}}$  are isomorphic. ■

## 2.5 Characterization of Cocircuit Graphs

We discuss in this section the characterization problem for cocircuit graphs of uniform oriented matroids and of any  $M$ -labeled cocircuit graphs. We have presented in the previous sections polynomial algorithms for the corresponding  $M$ -labeling and the  $OM$ -labeling problems. These algorithms did not check the correctness of the input. In this section we add input checks to the above algorithms and use them for the design of polynomial algorithms that solve the characterization problems of  $M$ -labeled cocircuit graphs and of (unlabeled) uniform cocircuit graphs.

Note that the algorithms for the  $M$ -labeling of cocircuit graphs of uniform oriented matroids and for the  $OM$ -labeling of  $M$ -labeled cocircuit graphs may run into problems if their input is not correct. If such a problem is detected on run time, it will cause the algorithm to abort (we say then, the algorithm *fails*), otherwise the algorithm will terminate with some output. In neither case will the complexity of the algorithms be affected. If an algorithm fails, we know that its input was not correct, otherwise the output of the algorithm will be used to decide whether the input was correct or not.

We discuss first the algorithmic characterization of  $M$ -labeled cocircuit graphs.

**2.5.1 Theorem** *Let  $G$  be a graph with label  $L : V(G) \rightarrow 2^E$ . There exists an algorithm which decides whether  $G$  is a cocircuit graph with  $M$ -label  $L$  or not, and this algorithm runs in time  $O(f_0^3 n^2)$ , where  $f_0 = |V(G)|$  and  $n := |E|$ .*

**Proof** First we use the algorithm `OMLABELFROMMLABEL` in order to obtain a label  $\mathcal{L}$  of  $G$ . Then we check the cocircuit axioms (C0) to (C3) for the set of all vertex labels  $\mathcal{L}(v)$ ; if not all axioms are valid, we know that the input  $G$  and  $L$  was not correct, i.e., we can stop and report that  $G$  is not a cocircuit graph with  $M$ -label  $L$ . If (C0) to (C3) are valid, we construct the cocircuit graph  $G_{\mathcal{L}}$  of the oriented matroid defined by  $\mathcal{L}$  and compare  $G_{\mathcal{L}}$  with the input graph  $G$ . If  $G$  and  $G_{\mathcal{L}}$  are the same (with vertices identified as they associate to the same cocircuits), then  $G$  is a cocircuit graph with  $M$ -label  $L$ , otherwise not. It remains to discuss the complexity of the above characterization algorithm; as we do not use any sophisticated data structure, our complexity result may be improved further. With  $f_1 = |E(G)|$ , we have a complexity of  $O((f_0 + f_1)n)$  for `OMLABELFROMMLABEL` in order to compute  $\mathcal{L}$ ; we check the cocircuit axioms which is trivially possible in  $O(f_0^3 n^2)$  elementary arithmetic steps. If all axioms are valid we construct the cocircuit graph  $G_{\mathcal{L}}$  from  $\mathcal{D}$  which can be done in  $O(f_0^3 n)$  elementary arithmetic steps as follows: The vertex set of  $G_{\mathcal{L}}$  is the same as for  $G$ . For every vertex  $v \in V(G_{\mathcal{L}})$  we determine in  $O(f_0^2 n)$  steps all adjacent vertices by first collecting all  $w \in V(G_{\mathcal{L}})$  for which  $D(\mathcal{L}(v), \mathcal{L}(w)) = \emptyset$ , then taking as the adjacent vertices of  $v$  those  $w$  for which  $(\mathcal{L}(v) \circ \mathcal{L}(w))^0$  is maximal among all such sets with  $w$  from the collection. The comparison of  $G_{\mathcal{L}}$  and  $G$  can be done together with the construction of  $G_{\mathcal{L}}$ . Obviously the overall complexity is bounded by  $O((f_0 + f_1)n) + O(f_0^3 n^2)$ , where the later term is dominating because of  $f_1 \leq f_0^2$ . ■

We discuss now the algorithmic characterization of unlabeled cocircuit graphs of uniform oriented matroids.

**2.5.2 Proposition** *Let  $G$  be a graph. There exists an algorithm which decides whether  $G$  is the cocircuit graph of some uniform oriented matroid  $(E, \mathcal{F})$  or not, and this algorithm runs in time  $O(f_0^3 f_1 n^2)$ , where  $f_0 = |V(G)|$ ,  $f_1 = |E(G)|$ , and  $n = |E|$ .*

**Proof** First we use the algorithm described in Section 2.4 in order to obtain a label  $L$  of  $G$  and to decide whether  $G$  is a cocircuit graph with M-label  $L$ . This is possible in time  $O(f_0^3 f_1 n^2)$ . It remains to check whether  $G$  is the cocircuit graph of some uniform oriented matroid. For this we simply check whether  $f_0 = 2\binom{n}{r-1}$  and whether all labels  $L(v)$  have cardinality  $r - 1$ , where  $r$  is determined from a vertex degree (e.g., see initialization of algorithm MLABELFROMCOLINECYCLES). ■

## 2.6 Open Problems

We discuss in this section some open problems that are closely related to the results of the present chapter. We concentrate on the case of uniform cocircuit graphs.

We have proved that the pairs of antipodal vertices are determined by the cocircuit graph of a uniform oriented matroid up to graph isomorphism, but it is an open question whether they are uniquely determined by the graph:

**Open Problem 1:** *Does there exist a uniform cocircuit graph  $G$  with AP-labels  $A$  and  $\tilde{A}$  such that  $A \neq \tilde{A}$ ?*

We know that in the uniform case the distance between two antipodal vertices is  $|E| - \text{rank}(\mathcal{M}) + 2$  and that there are exactly  $2(\text{rank}(\mathcal{M}) - 1)$  edge-disjoint shortest paths between them. We do not know whether this property is enough to characterize the antipodal pairs; if it is sufficient, we can detect the negative of a cocircuit quite easily (remember that one can compute efficiently  $\text{rank}(\mathcal{M})$  and  $|E|$  from  $|V(G)|$  and  $|E(G)|$ ):

**Open Problem 2:** *Does there exist a cocircuit graph  $G$  of a uniform oriented matroid  $\mathcal{M}$  with  $r := \text{rank}(\mathcal{M}) \geq 2$  and AP-label  $A$  and  $v, w \in V(G)$  such that  $w \neq A(v)$  and  $d_G(v, w) = n - r + 2$ , where  $n = |E|$  and  $r = \text{rank}(\mathcal{M})$  are determined by  $G$ ?*

**Open Problem 3:** *Does there exist a cocircuit graph  $G$  of a uniform oriented matroid  $\mathcal{M}$  with  $r := \text{rank}(\mathcal{M}) \geq 2$  and AP-label  $A$  and  $v, w \in V(G)$  such that  $w \neq A(v)$  and there are exactly  $2(r - 1)$  edge-disjoint shortest paths between  $v$  and  $w$ ?*

It is also an open question whether antipodal pairs are characterized as farthest pairs in  $G$ , i.e., whether the distance between two vertices  $v$  and  $w$  in  $G$  is equal to the diameter if and only if  $v = \overline{w}$ . It is easy to see that this is not true for non-uniform oriented matroids.

**Open Problem 4:** *Does there exist a cocircuit graph  $G$  of a uniform oriented matroid  $\mathcal{M}$  with AP-label  $A$  and  $v \in V(G)$  such that  $d_G(v, A(v)) \neq \text{diam}(G)$ , or such that  $d_G(v, w) = \text{diam}(G)$  for some  $w \neq A(v)$ ?*

Finally it is an open problem whether the diameter of a cocircuit graph is bounded linearly in  $n = |E|$ :

**Open Problem 5:** *Does there exist a constant  $k$  such that for every cocircuit graph  $G$  of an oriented matroid  $\mathcal{M} = (E, \mathcal{F})$  holds  $\text{diam}(G) \leq k \cdot |E|$ ?*

We can show the following quadratic bound on the diameter of a uniform cocircuit graph:

**2.6.1 Proposition** *Let  $\mathcal{M} = (E, \mathcal{F})$  be a uniform oriented matroid and  $G$  its cocircuit graph. Note that  $r = \text{rank}(\mathcal{M})$  and  $n = |E|$  are determined by  $G$ . The diameter of  $G$  is bounded by*

$$\text{diam}(G) \leq n - r + 2 + \sum_{k=1}^{\min(r-2, n-r)} \left( \left\lfloor \frac{n-r-k}{2} \right\rfloor + 1 \right).$$

**Proof** The proof is mainly based on Lemma 2.3.5 (iii). Fix any vertex  $v_0 \in V(G)$ . The maximum distance of any coline cycle in  $G$  is bounded by  $r - 2$  (since  $|U| = r - 2$  for any coline  $U$ ) and  $n - r + 1$  (since  $|U \setminus L(v_0)| \leq |E \setminus L(v_0)| = n - r + 1$ ). A coline cycle contains  $2(n - r + 2)$  vertices, hence Lemma 2.3.5 (iii) implies that every vertex on a coline cycle of distance  $n - r + 1$  is on a coline cycle of distance  $n - r$ . Consider some vertex  $v \in V(G)$ . The above arguments imply that there is a coline cycle  $c$  of distance  $k \leq \min(r - 2, n - r)$  which contains  $v$ . If  $k = 0$  then obviously  $d_G(v_0, v) \leq n - r + 2$ . If  $k \geq 1$  we show that  $v$  is connected to some vertex  $v'$  which is contained on a coline cycle of distance  $k - 1$  with  $d_G(v, v') \leq \left\lfloor \frac{n-r-k}{2} \right\rfloor + 1$ , which implies the claim. We can find such  $v'$  on  $c$ , since  $c$  contains  $2(k + 1)$  vertices on at least one coline cycle of distance  $k - 1$  and hence  $2(n - r - k)$  vertices different from  $v$  and its antipode  $\bar{v}$  which do not have this property (see Lemma 2.3.5 (iii)). As every pair of antipodes is contained in the same coline cycles, the minimum distance of  $v$  to a  $v'$  which lies on a coline cycle of distance  $k - 1$  is at most  $\left\lfloor \frac{n-r-k}{2} \right\rfloor + 1$ . ■

The above bound is tight in the special (and trivial) cases there  $r = 2$  or  $r = |E|$ . Furthermore a similar proof extends the bound to some quadratic bound for cocircuit graphs of general oriented matroids.





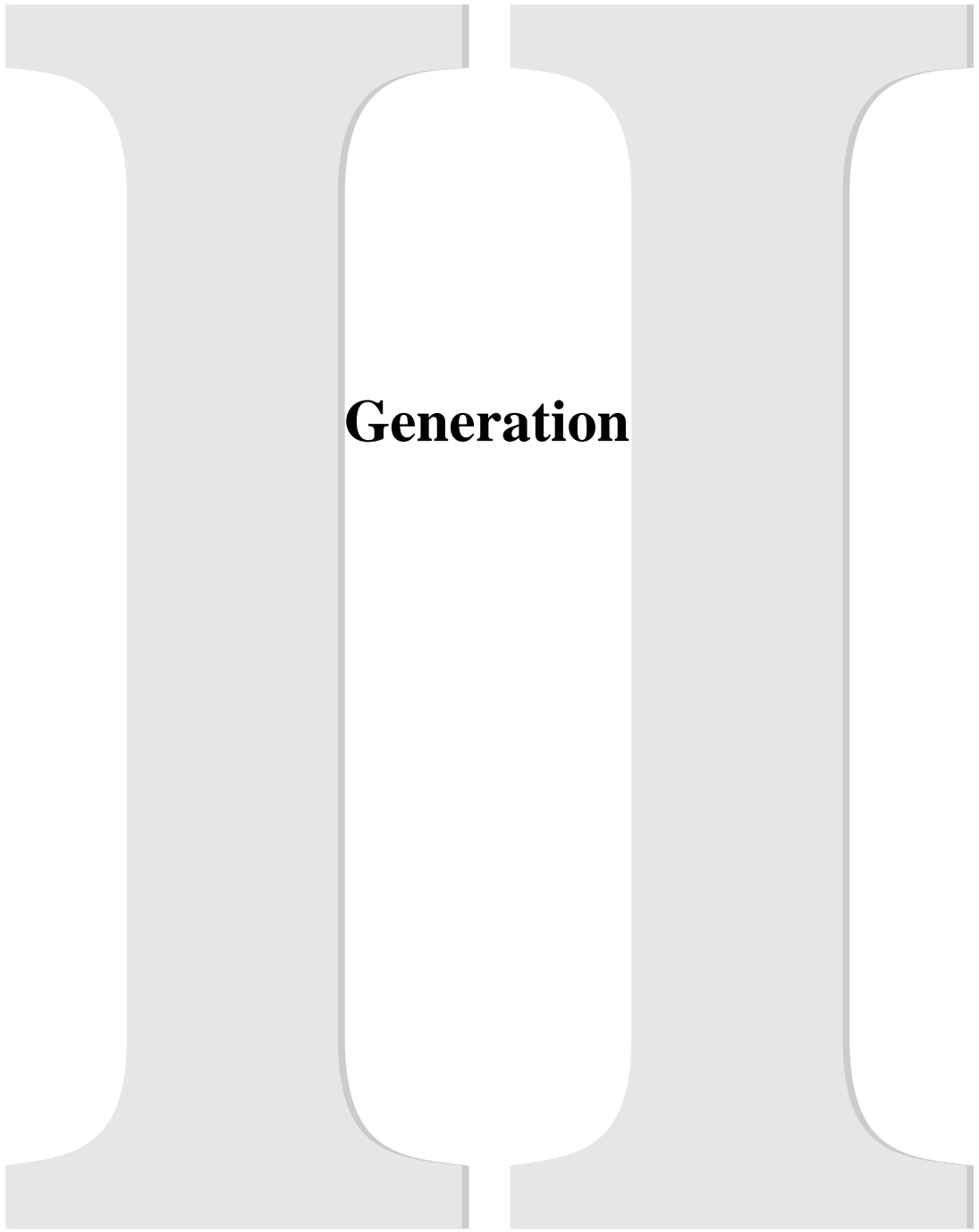

**Generation**



## Chapter 3

# Generation of Oriented Matroids and Isomorphism Classes

### 3.1 Introduction

The present chapter introduces the generation problem of oriented matroids, the fundamental question of constructing all oriented matroids of some given size  $n$  of the ground set  $E$  and rank  $r$ :

**Oriented Matroid Generation Problem:** *Given integers  $n$  and  $r$ , generate all oriented matroids  $\mathcal{M} = (E, \mathcal{F})$  with  $n = |E|$  and  $r = \text{rank}(\mathcal{M})$ .*

If we assume some canonical way to label the elements, say  $E = \{1, 2, \dots, n\}$ , the oriented matroid generation problem is finite: Obviously  $|\mathcal{F}| \leq 3^n$  and hence there are not more than  $2^{(3^n)}$  oriented matroids with  $n$  elements; furthermore any set of sign vectors can be checked in polynomial time whether it is the set of covectors of an oriented matroid of rank  $r$ . However, for methods of theoretical and practical interest we will have to exploit the properties of oriented matroids much more.

The generation problem is motivated by several questions in discrete geometry which all are very hard to resolve, such as classification of combinatorial types of point configurations, polytopes, hyperplane arrangements, or realizability problems concerning abstract combinatorial manifolds. Having a classification of combinatorial types makes it possible to test conjectures against this complete set of problem instances. On the other hand, the study of methods for efficiently generating oriented matroids leads to new results for oriented matroid representations.

Techniques for listing oriented matroids for small  $n$  and  $r$  were studied, among others, by Bokowski, Sturmfels, and Guedes de Oliveira (e.g., [BS87, BS89, BGdO00]) using the chirotope axioms of oriented matroids. They also showed by successful applications to

geometric embeddability problems the usefulness of oriented matroid generation. However, it seems that the methods are designed primarily for the case of uniform oriented matroids. Our approach is based on graph theoretical representations of oriented matroids (tope graphs and cocircuit graphs), and we will discuss methods which work for general oriented matroids (especially also non-uniform oriented matroids). One of our methods can be considered as a more general variant of an algorithm of Bokowski and Guedes de Oliveira [BGdO00] in a dual setting; however, our representation leads to implementations which are able to handle easily any single element extension in general rank, for non-uniform and uniform oriented matroids as well.

Many questions which can be solved when having a complete list of oriented matroids for given  $r$  and  $n$  only depend on the isomorphism class, e.g., questions concerning the face lattice of an oriented matroid. Furthermore, other classes of oriented matroids (like reorientation classes) are usually obtained rather easily from the isomorphism classes. This motivates to generate isomorphism classes first and then finer classifications in a separate step. Finally, we will see that the methods for generating oriented matroids can be restricted quite naturally to generation of isomorphism classes only. Hence, we will concentrate on the generation of isomorphism classes:

**Isomorphism Class Generation Problem:** *Given integers  $n$  and  $r$ ,*

*generate all oriented matroids  $\mathcal{M} = (E, \mathcal{F})$  with  $n = |E|$  and  $r = \text{rank}(\mathcal{M})$  up to isomorphism, i.e., generate one representative from every isomorphism class where the representative is assumed to be simple.*

With our restriction to simple oriented matroids the problem becomes well-defined as then  $n = |E|$  is the number of parallel classes (of non-loop elements) which is an invariant of the isomorphism class.

Before we introduce a general, incremental method for the generation of isomorphism classes of oriented matroids in Section 3.3 and the underlying representations by graphs (see Section 3.4), we consider the role of duality in the context of oriented matroid generation and some special cases where duality is very helpful.

## 3.2 Duality and the Generation of Isomorphism Classes

This section discusses the duality of oriented matroids in relation to the generation of isomorphism classes. The key observation is that all oriented matroids on a ground set  $E$  and rank  $r$  can be obtained by dualization from a complete list of oriented matroids on  $E$  and rank  $|E| - r$  (see Corollary 0.5.10); the computation of the dual can be assumed to be easy (cf. Lemma 0.9.8). Essentially it is sufficient to generate only one of the two lists of oriented matroids. However, for the generation of isomorphism classes the dualization approach is not that straightforward, as we will discuss in the following.

**3.2.1 Definition (Co-parallel, Co-simple)** Let  $\mathcal{M} = (E, \mathcal{F})$  be an oriented matroid. Two elements  $e, f \in E$  are called *co-parallel* if  $e, f$  are parallel in  $\mathcal{M}^*$ .  $\mathcal{M}$  is called

*co-simple* if it has no coloops and no co-parallel elements (or, equivalently, if  $\mathcal{M}^*$  is simple).

It will be useful to characterize co-parallel elements as follows:

**3.2.2 Lemma** *Let  $\mathcal{M} = (E, \mathcal{F})$  be an oriented matroid. Two elements  $e, f \in E$  are co-parallel if and only if  $\text{rank}(\mathcal{M}/(E \setminus \{e, f\})) = 1$ .*

**Proof** Let  $\mathcal{M} = (E, \mathcal{F})$  be an oriented matroid. Consider its dual  $\mathcal{M}^*$ , two elements  $e, f \in E$ , and the deletion minor  $\mathcal{M}^* \setminus (E \setminus \{e, f\})$ , which only has the two elements  $e$  and  $f$  in the ground set. By Lemma 0.7.5,  $e$  and  $f$  are parallel elements of  $\mathcal{F}^*$  if and only if  $\text{rank}(\mathcal{M}^* \setminus (E \setminus \{e, f\})) = 1$ . By Corollary 0.5.10 and Lemma 0.5.2, this is the case if and only if  $\text{rank}(\mathcal{M}/(E \setminus \{e, f\})) = 1$ . ■

The main difficulty of the dualization approach comes from the fact that, according to our definition of isomorphism of oriented matroids (see Definition 1.1.2), dualization does not preserve isomorphism. For example, the duals of two isomorphic oriented matroids which only differ by loops differ by coloops and are not isomorphic. One might prefer a different definition of the notion of isomorphism which does not allow the introduction or deletion of loops and parallel elements but only the renaming of elements; then duality would preserve isomorphism, however, the one-to-one correspondence with face lattices is lost. Another idea is to generate only those oriented matroids (up to reorientation and renaming of the elements) which are simple and also co-simple; again, then the lists become symmetric under dualization but no longer reflect a complete list of isomorphism classes in our (preferred) sense.

In order to generate all isomorphism classes from dual oriented matroids, we will generate a complete list of co-simple oriented matroids as we discuss in detail for the special cases of oriented matroids with  $n = |E|$  elements which are of rank  $n$ ,  $n - 1$ , and  $n - 2$ .

An oriented matroid with  $n$  elements of rank  $r = n$  is, up to the naming of the elements, uniquely determined as follows (hence there is only one isomorphism class for every  $r = n$ ):

**3.2.3 Lemma (Oriented Matroids with rank( $\mathcal{M}$ ) =  $|E|$ )** *Let  $\mathcal{M} = (E, \mathcal{F})$  be an oriented matroid with  $\text{rank}(\mathcal{M}) = |E|$ . Then  $\mathcal{F} = \{-, +, 0\}^E$ . In particular,  $\mathcal{M}$  is uniform.*

**Proof** Let  $\mathcal{M} = (E, \mathcal{F})$  be an oriented matroid with  $\text{rank}(\mathcal{M}) = |E|$ . By Corollary 0.5.10, the dual of  $\mathcal{M}$  is an oriented matroid of rank 0, hence  $\mathcal{M}^* = (E, \{\mathbf{0}\})$  (cf. Lemma 0.7.14). Since  $\mathcal{M}$  is the dual of  $\mathcal{M}^*$  (see Proposition 0.5.8), the claim follows from the definition of duals (Definition 0.5.1).

A different proof (which does not use duality) can be given using similar arguments as in the proof of Lemma 1.5.3. ■

Duals of oriented matroids of rank  $n - 1$  have rank 1. By Lemma 0.7.14, there are up to renaming of the elements in  $E$  only  $n$  oriented matroids of rank 1, say  $\mathcal{M}_0, \dots, \mathcal{M}_{n-1}$ , where the index indicates the number of loops. The duals of those of them which are

co-simple represent the isomorphism classes of the oriented matroids of rank  $n - 1$ . The only non-loop element of  $\mathcal{M}_{n-1}$  is a coloop, hence  $\mathcal{M}_{n-1}$  is not co-simple. The remaining oriented matroids  $\mathcal{M}_0, \dots, \mathcal{M}_{n-2}$  do not have coloops. If for some  $\mathcal{M}_i$  there exist co-parallel elements  $e, f$ , then by Lemma 3.2.2  $\text{rank}(\mathcal{M}_i/(E \setminus \{e, f\})) = 1$ . Obviously, this is only the case if all elements in  $E \setminus \{e, f\}$  are loops; hence, only  $\mathcal{M}_{n-2}$  (and  $\mathcal{M}_{n-1}$ ) may have co-parallel elements, which is indeed the case. In sum,  $\mathcal{M}_0, \dots, \mathcal{M}_{n-3}$  are co-simple, and  $\mathcal{M}_{n-2}$  and  $\mathcal{M}_{n-1}$  are not:

**3.2.4 Lemma** *There are  $n - 2$  isomorphism classes of (simple) oriented matroids of  $n$  elements and rank  $n - 1$ .*

For the study of oriented matroids of rank  $n - 2$  we basically use the same idea as above in the case of rank  $n - 1$ . Without loss of generality,  $E = \{1, \dots, n\}$ . In order to count all isomorphism classes in rank  $n - 2$ , we count the number of co-simple oriented matroids on  $E$  of rank 2 up to permutation and reorientation of the elements. The case of rank 2 is well-characterized (see Corollary 1.4.4), and every oriented matroid of rank 2 up to permutation and reorientation of the elements is represented by a circular diagram indicating the cardinality and the (circular) order of the parallel classes of non-loop elements and the number of loops. Figure 3.1 shows all diagrams with 2 and 3 elements (the number in the center is the number of loops). These diagrams can also be written,

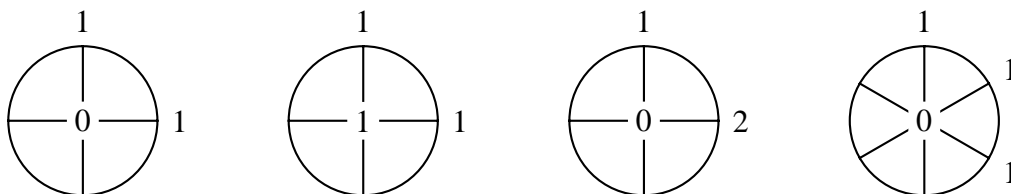

Figure 3.1: Diagrams of oriented matroids of rank 2 with 2 and 3 elements

e.g., in the following notation:  $(1, 1; 0)$ ,  $(1, 1; 1)$ ,  $(1, 2; 0)$ ,  $(1, 1, 1; 0)$ . The 7 diagrams with 4 elements are the last three diagrams of Figure 3.1, where the number of loops is increased by 1, together with the diagrams of Figure 3.2, in short notation  $(1, 1; 2)$ ,

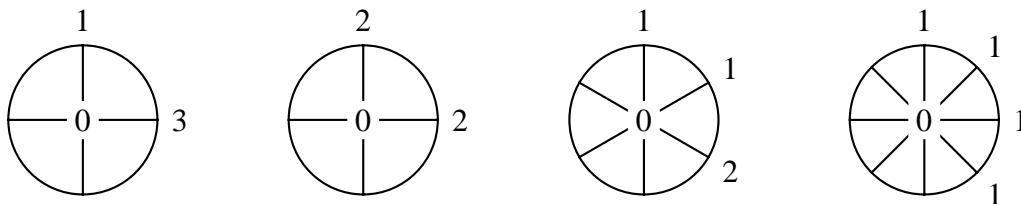

Figure 3.2: Diagrams of oriented matroids of rank 2 with 4 non-loop elements

$(1, 2; 1)$ ,  $(1, 1, 1; 1)$ , and  $(1, 3; 0)$ ,  $(2, 2; 0)$ ,  $(1, 1, 2; 0)$ ,  $(1, 1, 1, 1; 0)$ . The diagrams are unique up to symmetry, e.g.,  $(1, 2, 3; 0)$  is equivalent to  $(1, 3, 2; 0)$ . Simplifying our notation, we write  $(n_1, \dots, n_k)$  for  $(n_1, \dots, n_k; 0)$  if there is no loop. The diagrams for 5 elements are those for 4 elements with one additional loop and the following which do not have loops:  $(1, 4)$ ,  $(2, 3)$ ,  $(1, 1, 3)$ ,  $(1, 2, 2)$ ,  $(1, 1, 1, 2)$ ,  $(1, 1, 1, 1, 1)$ . Such diagrams

can be enumerated rather easily also for a higher number of elements. It remains to discuss which diagrams correspond to co-simple oriented matroids. An element is a coloop if and only if the rank decreases if it is deleted. Hence, a coloop is the only element of its parallel class and there is only one other parallel class of non-loop elements. Among the diagrams discussed so far, those having a coloop are  $(1, 1)$ ,  $(1, 2)$ ,  $(1, 3)$ ,  $(1, 4)$ , and their extensions by loops. Two elements  $e, f$  are co-parallel, according to Lemma 3.2.2, if  $\text{rank}(\mathcal{M}/(E \setminus \{e, f\})) = 1$ . Hence, a diagram has co-parallel elements if there is a parallel class of one or two non-loop elements and only one other parallel class of non-loop elements or there are two parallel classes of one non-loop element and only one further parallel class of non-loop elements. For example, co-parallel elements are in oriented matroids represented by  $(1, 1, 1)$ ,  $(2, 2)$ ,  $(1, 1, 2)$ ,  $(2, 3)$ ,  $(1, 1, 3)$ . Finally, the diagrams of co-simple oriented matroids up to 5 non-loop elements are: none with less than 4 elements,  $(1, 1, 1, 1)$  with 4 elements, and  $(1, 2, 2)$ ,  $(1, 1, 1, 2)$ ,  $(1, 1, 1, 1, 1)$  with 5 elements. Further enumeration leads to 8, 13, 25, 41, 73, 121, 219, 375, 682, 1219, 2245, 4107, 7680, 14305, 27007 co-simple non-loop diagrams for  $n = 6, \dots, 20$ , respectively. The corresponding numbers with loops are the sums of the first  $n$  numbers without loops. Hence, there are 1, 4, 12, 25, 50, 91, 164, 285, 504, 879, 1561, 2780, 5025, 9132, 16812, 31117, 58124 isomorphism classes of (simple) oriented matroids of rank  $n - 2$  with  $n$  elements for  $n = 4, \dots, 20$ , respectively.

The duality approach for the investigation and enumeration of combinatorial objects has also been applied earlier, as in the context of combinatorial types of convex polytopes (e.g., [Grü67, Llo70, Stu88], see also Section 7.4). In some cases, the enumeration leads to a formula for the number of instances for given  $n$ ; it is possible that there is also a formula for the number of isomorphism classes of oriented matroids of rank  $n - 2$ . The general case, where the rank is not  $n$ ,  $n - 1$ , or  $n - 2$ , needs further investigation; at least there is no simple characterization of the duals (which are oriented matroids of rank 3, 4,  $\dots$ ), and hence no straightforward enumeration of all cases. Even if duality is very helpful in special cases and may reduce the amount of enumeration in higher rank considerably, we restrict ourselves for the following investigations to primal generation methods. These methods will handle all cases in the same way and produce complete listings of isomorphism classes also for high rank.

### 3.3 Incremental Method for the Generation of Isomorphism Classes

This section presents an incremental method of the generation methods which are discussed in the following chapters. The oriented matroids are generated incrementally by a number of single element extensions, i.e., extensions where only one new element is introduced. This generation by means of single element extensions was used also in the former methods for the generation of oriented matroids. We will extend these methods such that only isomorphism classes of oriented matroids are generated.

For our methods we consider the following well-characterized cases as starting points of the incremental generation process:

- $r \leq 1$ : Oriented matroids of rank 1 or 0 have been characterized in Lemma 0.7.14 and are rather trivial.
- $r = 2$ : These oriented matroids are well-characterized (see Corollary 1.4.4).
- $r = n$ : An oriented matroid whose rank equals the numbers of elements can be characterized as stated in Lemma 3.2.3.

**3.3.1 Definition (Extension, Single Element Extension)** Let be  $\mathcal{M} = (E, \mathcal{F})$  and  $\mathcal{M}' = (E', \mathcal{F}')$  oriented matroids. We call  $\mathcal{M}'$  an *extension* of  $\mathcal{M}$  if  $\mathcal{M} = \mathcal{M}' \setminus R$  for some  $R \subseteq E'$ . We call  $\mathcal{M}'$  an *single element extension* of  $\mathcal{M}$  if  $\mathcal{M} = \mathcal{M}' \setminus f$  for some  $f \in E'$ .

Every oriented matroid  $\mathcal{M} = (E, \mathcal{F})$  can be obtained by single element extensions from some oriented matroid with less than  $|E|$  elements. The incremental method may start with some trivial oriented matroid with 0 or 1 element. Some of the single element extensions may increase the rank (by introducing a coloop). The following lemma states that such rank increasing extensions can be avoided:

**3.3.2 Lemma** *Every oriented matroid  $\mathcal{M} = (E, \mathcal{F})$  can be obtained by single element extensions from an oriented matroid of same rank  $r = \text{rank}(\mathcal{M})$  with  $r$  elements.*

**Proof** Let  $\mathcal{M} = (E, \mathcal{F})$  be an oriented matroid. If all elements in  $E$  are coloops then  $r = |E|$ , otherwise there exists  $e \in E$  which is not a coloop, and by Corollary 0.4.9 (i) the rank of  $\mathcal{M} \setminus e$  is the same as the rank of  $\mathcal{M}$ . This proves that every oriented matroid can be obtained by single element extensions from an oriented matroid of the same rank  $r$  which has  $r$  elements. ■

For the generation of oriented matroids (or of isomorphism classes of oriented matroids) both approaches are of interest, generation from  $n = 0, 1, 2$  and generation from  $n = r$  without increasing rank.

Let  $\text{IC}(n, r)$  denote the set of all isomorphism classes of oriented matroids with  $n$  parallel classes in  $E \setminus E^0$ , where  $E^0$  is the set of loops, and of rank  $r$ . Every class in  $\text{IC}(n, r)$  can be represented by an oriented matroid of rank  $r$  with  $n$  elements in the ground set which is simple, i.e., there are no parallel elements  $e \neq f$  and no loops. We will always think of  $\text{IC}(n, r)$  as a set or list of such representatives. Note that  $\text{IC}(n, r)$  is empty if  $n < r$  or if  $r < 2$  and  $n \neq r$ . Figure 3.3 shows a diagram of all nonempty  $\text{IC}(n, r)$  up to  $n = 5$ , and the arrows indicate how these isomorphism classes may be generated as discussed in the following.

For the incremental step in the generation method consider some  $\text{IC}(n, r)$ . By Corollary 0.4.9 (i) every representative of  $\text{IC}(n, r)$  is a single element extension of oriented matroids represented in  $\text{IC}(n - 1, r - 1)$  and  $\text{IC}(n - 1, r)$ . However, in general every isomorphism class in  $\text{IC}(n, r)$  is obtained in multiple ways since every oriented matroid with  $n$  elements is a single element extension of up to  $n$  different deletion minors, furthermore different single element extensions of one oriented matroid may be isomorphic. This



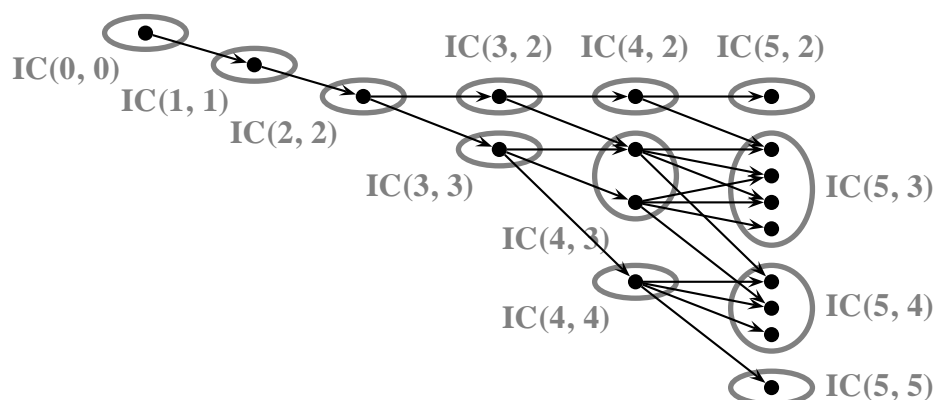

Figure 3.3: Relation of isomorphism classes of oriented matroids under single element extensions for  $n \leq 5$

problem of multiple generation will be attacked in (at least) two ways: not all but only sufficiently many extensions are considered, and extensions are tested for being isomorphic, e.g., by means of canonical representations of isomorphism classes. Let us summarize which problems have been addressed in this section:

**Single Element Extension Problem:** *Given an oriented matroid  $\mathcal{M}$ , find all single element extensions of  $\mathcal{M}$ .*

**Multiple Extension Reduction Problem:** *Find a rule which identifies redundant single element extension such that every isomorphism class of oriented matroids can be obtained by a sequence of non-redundant single element extensions.*

**Isomorphism Checking Problem:** *Given two oriented matroids  $\mathcal{M}$  and  $\mathcal{M}'$ , decide whether  $\mathcal{M}$  and  $\mathcal{M}'$  are isomorphic or not.*

**Isomorphism Class Representation Problem:** *Find a canonical representation of isomorphism classes of oriented matroids (say, in form of an algorithm ICREP) such that the representation of two oriented matroids is the same if and only if they are isomorphic:  $\text{ICREP}(\mathcal{M}) = \text{ICREP}(\mathcal{M}')$  if and only if  $\mathcal{M}' \in \text{IC}(\mathcal{M})$ .*

The combination of the elements discussed so far leads to an incremental method for the generation of oriented matroids up to isomorphism. Starting from  $\text{IC}(2, 2)$ , say, which consists of one class (e.g., represented by the oriented matroid with  $E = \{1, 2\}$ , and  $\mathcal{F} = \{-, +, 0\}^2$ ), the method generates as sketched above  $\text{IC}(n, r)$  with increasing  $n$  and  $r$  (i.e., in some order such that  $\text{IC}(n-1, r-1)$  and  $\text{IC}(n-1, r)$  are generated before  $\text{IC}(n, r)$ ). The diagram in Figure 3.3 shows which isomorphism classes of oriented matroids are obtained from others by single element extensions (up to  $n = 5$ ). In a variant of the method the starting point is  $\text{IC}(r, r)$  for given  $r$  and generates  $\text{IC}(n, r)$  with increasing  $n$  using only non-coloop extensions. Every single element extension is then tested against the others w.r.t. isomorphism such that only a list of representatives of  $\text{IC}(n, r)$  is kept.

### 3.4 Graph Representations in Generation Methods

In any generation method, the choice of the underlying oriented matroid representation is of great importance. The representations which are discussed in the following are mainly based on graphs that are defined by the oriented matroids, namely tope graphs (see Chapter 1) and cocircuit graphs (see Chapter 2). These graph representations are well suited to the generation of isomorphism classes of oriented matroids:

- isomorphic oriented matroids have same cocircuit graph and same tope graph (in fact, tope graphs characterize isomorphism classes; for cocircuit graphs we will add extra information),
- graphs are a relatively compact structure,
- all isomorphism classes can be represented without special treatment (i.e., also non-uniform cases in any rank),
- the graph representations are useful for the solution of all of the problems mentioned in the previous section.

A short discussion of the well-characterized oriented matroids may illustrate the representation of isomorphism classes by tope graphs and cocircuit graphs.

- The oriented matroid for  $r = 0$  (and hence  $n = 0$ ) is represented by the tope graph which has one vertex and no edges, or the cocircuit graph which is the empty graph.
- The oriented matroid for  $r = 1$  (and hence  $n = 1$ ) is represented by the tope graph which has two vertices connected by one edge, or the cocircuit graph which has two vertices and no edge.
- The oriented matroid for  $r = 2$  and  $n \geq 2$  is represented by the tope graph which is a cycle of length  $2n$ , or the cocircuit graph which is a cycle of length  $2n$  (see Proposition 1.2.9 and Lemma 2.2.1).
- The oriented matroid for  $r = n$  is represented by
  - the tope graph which is the 1-skeleton of the  $r$ -dimensional hypercube (see Figure 3.5 for an illustration with  $r = 3$ ), or
  - the cocircuit graph which is the 1-skeleton of the  $r$ -dimensional cross polytope, i.e., every vertex is neighbor of every other vertex except one (see Figure 3.6 for an illustration with  $r = 3$ ); the cocircuit graph will be considered together with a list of coline cycles.

Let us illustrate the use of cocircuit graphs and tope graphs for the example of the single element extension problem. Consider a pseudosphere arrangement (see Section 0.1) with cell complex  $\mathcal{K}$  and corresponding oriented matroid  $\mathcal{M} = (E, \mathcal{F})$ . Remember that the cocircuit graph is the 1-skeleton of  $\mathcal{M}$  (or  $\mathcal{K}$ ), the tope graph is defined by the adjacency

relation of the topes in  $\mathcal{M}$  (which corresponds to the obvious adjacency relation of the  $d$ -faces in  $\mathcal{K}$ ). If a new element  $f \notin E$  is added, i.e., a new  $(d - 1)$ -dimensional pseudosphere  $S_f$  is introduced, this defines a new complex  $\mathcal{K}'$  and a single element extension  $\mathcal{M}' = (E \cup \{f\}, \mathcal{F}')$  of  $\mathcal{M}$  (see also Figure 3.4, the new sphere is dashed).

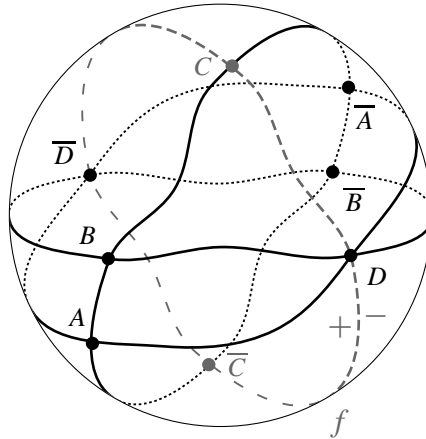

Figure 3.4: Extension of pseudosphere arrangement

The new element  $f$  partitions the set of topes into three parts, those which are on the  $-$  side of  $f$ , those on the  $+$  side of  $f$ , and those “cut” by  $f$ : In the cell complex  $\mathcal{K}$  these correspond to  $d$ -faces which are on the  $-$  or  $+$  side of  $f$  and  $d$ -faces which are divided by  $S_f$  into two new  $d$ -faces, respectively. Hence this single element extension defines a signature on the vertex set of the tope graph where vertices are labeled by  $-$ ,  $+$ , or  $0$  according to the three mentioned cases (see Figure 3.5). If a signature comes from a single

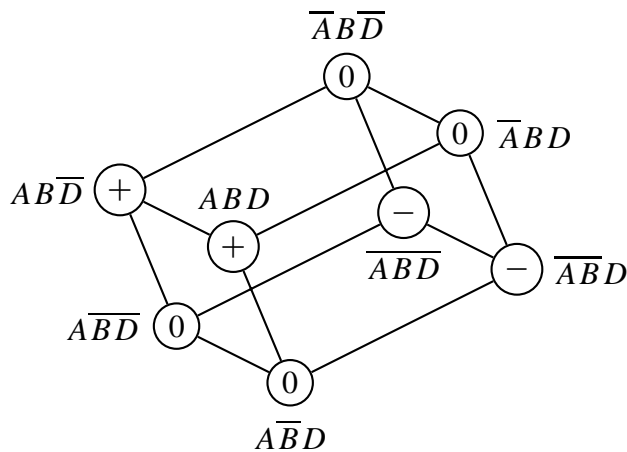

Figure 3.5: Localization of tope graph

element extension as discussed above, then it is called a *localization* of the tope graph. We will see that localizations characterize single element extensions up to reorientation and relabeling of the new element, and we will discuss single element extensions in terms of localizations of tope graphs (see Chapter 4). Our methods will generate localizations

of a given tope graphs  $G$ , and it will be easy to extend  $G$  for every localization to the tope graph of the corresponding single element extension.

Similarly as for topes, the new element  $f$  partitions the set of cocircuits into three parts, as correspondingly the 0-faces in the cell complex  $\mathcal{K}$  are on the  $-$  or  $+$  side of  $S_f$  or contained in  $S_f$ . This partition defines a signature on the vertex set of the cocircuit graph (see Figure 3.6). Again, if a signature comes from a single element extension then it is

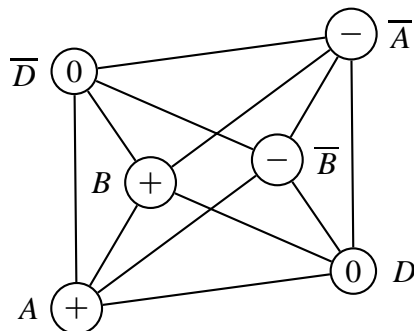

Figure 3.6: Localization of cocircuit graph

called a *localization* of the cocircuit graph. Note that in general the cocircuit graph is not sufficient to characterize the face lattice of  $\mathcal{K}$ , and similarly the notion of a localization is not well-defined without some extra information which is added to the cocircuit graph. We will see that the set of coline cycles will be perfect when discussing localizations of cocircuit graphs, as well as for characterizations as for generation of localizations. Localizations of a cocircuit graph, given with an M-label up to isomorphism, determine single element extensions up to isomorphism. Therefore, we can generate all single element extensions of a given oriented matroid by generating all localizations of its cocircuit graph by extending the cocircuit graph and its M-label for any given localization.

The following chapters discuss specific algorithmic solutions of the generation problem and the related problems: in Chapter 4 the methods are based on tope graphs, in Chapter 5 on cocircuit graphs, finally Chapter 6 is based on the results of Chapter 5 and in addition introduces the representation of chirotopes (see also Section 0.9) which are helpful for the definition of canonical representations of isomorphism classes. The main results of Chapters 4 and 5 are also presented in [FF01].

*Make no collection of it: let him show  
His skill in the construction.*

CYMBELINE (5,5)

## Chapter 4

# Tope Graphs and Single Element Extensions

This chapter presents methods which solve the isomorphism class generation problem of oriented matroids and are based on tope graphs of oriented matroids. For the problem statements and an overview of the approach see Chapter 3. A strong motivation for the use of tope graphs of oriented matroids has been the fact that a tope graph characterizes the isomorphism class of the corresponding oriented matroid (see Corollary 1.4.2) and that single element extensions of acycloids, a generalization of oriented matroids (see Section 1.2), can be characterized in terms of tope graphs as discussed in the following.

### 4.1 Tope Graphs and Isomorphism Classes of Oriented Matroids

We discuss in this section in more detail the connections between tope graphs and isomorphism classes of oriented matroids, before we enter the discussion of generation methods in the following sections.

Let  $G$  be the tope graph of an oriented matroid  $\mathcal{M}$ , associated by a bijection  $\mathcal{L} : V(G) \rightarrow \mathcal{T}$  to the set of topes. By Corollary 1.4.2,  $\mathcal{M}$  is determined by  $G$  up to isomorphism, and clearly also every oriented matroid in  $\text{IC}(\mathcal{M})$  has  $G$  as its tope graph. Even more remarkable, the discussion of algorithm `ACYCLOIDORIENTATIONRECONSTRUCTION` in Section 1.4 shows that also  $\mathcal{L}$  is determined up to isomorphism by  $G$ , i.e., if  $\mathcal{L}$  and  $\mathcal{L}'$  are two associating bijections from  $V(G)$  to tope sets  $\mathcal{T}$  and  $\mathcal{T}'$  of oriented matroids  $\mathcal{M}$  and  $\mathcal{M}'$ , respectively, then there exists an isomorphism between  $\mathcal{M}$  and  $\mathcal{M}'$  which also maps  $\mathcal{L}(v)$  to  $\mathcal{L}'(v)$  for every vertex  $v \in V(G)$ .

For the following detailed discussion of isomorphisms of oriented matroids and tope

graphs the notion of “isomorphism” has to be very clear. By Definition 1.1.2, two oriented matroids are isomorphic if their sets of covectors (or, equivalently, their sets of topes) coincide under some relabeling and reorientation of the elements, where relabeling includes the creation and deletion of parallel elements and loops. Then an isomorphism is a map which relabels (in the same sense as before) and reorients elements. Now, an automorphism of an oriented matroid is a self-isomorphism, and naturally relabeling here will not delete or create any elements as the ground set remains the same, hence relabeling then means permuting the elements in the ground set. Furthermore, it is not interesting to study automorphism which permute elements within parallel classes or loops, therefore we restrict the following discussion to simple oriented matroids where all parallel classes have cardinality one and no loops exist.

We denote the concatenation of maps  $\rho, \sigma$  simply by  $\rho\sigma$  ( $\rho$  after  $\sigma$ ), and the inverse of a bijection  $\tau$  by  $\tau^{-1}$ .

**4.1.1 Definition (Aut( $\mathcal{M}$ ))** Let  $\mathcal{M} = (E, \mathcal{F})$  be a simple oriented matroid, i.e., there are no parallel elements  $e \neq f$  and no loops. Then  $\text{Aut}(\mathcal{M})$  is the set of automorphisms of  $\mathcal{M}$ , i.e.,  $\phi = \rho\pi$  with  $\rho$  a reorientation and  $\pi$  a permutation on  $E$  belongs to  $\text{Aut}(\mathcal{M})$  if and only if  $\mathcal{F} = \{\phi(X) \mid X \in \mathcal{F}\}$ .

Note that it is equivalent to define  $\text{Aut}(\mathcal{M})$  by topes instead of covectors, i.e., replacing  $\mathcal{F}$  by  $\mathcal{T}$  in Definition 4.1.1 leads to the same definition (cf. Proposition 0.7.3).

It is remarkable how closely related automorphisms of tope graphs and oriented matroids are (for the notion of groups and group isomorphisms see for example [Asc00]):

**4.1.2 Proposition** Let  $\mathcal{M}$  be a simple oriented matroid with tope graph  $G$ . Then  $\text{Aut}(G)$  and  $\text{Aut}(\mathcal{M})$  are isomorphic groups.

**Proof** Let  $\mathcal{M}$  be a simple oriented matroid with tope graph  $G$  and associating bijection  $\mathcal{L} : V(G) \rightarrow \mathcal{T}$ .

- $\phi_g := \mathcal{L}g\mathcal{L}^{-1} \in \text{Aut}(\mathcal{M})$  for every  $g \in \text{Aut}(G)$ : By Corollary 1.4.2,  $\mathcal{T}$  is determined by  $G$  up to isomorphism, i.e., since  $g$  is a graph automorphism there exist  $\phi \in \text{Aut}(\mathcal{M})$  such that  $\mathcal{L}g = \phi\mathcal{L}$ , hence  $\phi_g = \mathcal{L}g\mathcal{L}^{-1} = \phi \in \text{Aut}(\mathcal{M})$ .
- $g_\phi := \mathcal{L}^{-1}\phi\mathcal{L} \in \text{Aut}(G)$  for every  $\phi \in \text{Aut}(\mathcal{M})$ : For all  $v, w \in V(G)$  and every  $\phi \in \text{Aut}(\mathcal{M})$ ,  $|D(\mathcal{L}(v), \mathcal{L}(w))| = |D(\phi\mathcal{L}(v), \phi\mathcal{L}(w))|$ , hence (by Proposition 1.2.4) all distances in  $G$  are preserved under  $g_\phi := \mathcal{L}^{-1}\phi\mathcal{L}$ , hence  $g_\phi \in \text{Aut}(G)$ .
- $g \mapsto \phi_g$  and  $\phi \mapsto g_\phi$  are inverse to each other, which follows by definition. Hence these maps establish bijections between  $\text{Aut}(G)$  and  $\text{Aut}(\mathcal{M})$ . Furthermore,

$$\phi_{gh} = \mathcal{L}gh\mathcal{L}^{-1} = \mathcal{L}g\mathcal{L}^{-1}\mathcal{L}h\mathcal{L}^{-1} = \phi_g\phi_h$$

for all  $g, h \in \text{Aut}(G)$ , and

$$g_{\phi\psi} = \mathcal{L}^{-1}\phi\psi\mathcal{L} = \mathcal{L}^{-1}\phi\mathcal{L}\mathcal{L}^{-1}\psi\mathcal{L} = g_\phi g_\psi$$

for all  $\phi, \psi \in \text{Aut}(\mathcal{M})$ . ■

Of more practical interest is the question of how two tope graphs can be tested for being isomorphic. The method which is described in the following is motivated by algorithm `ACYCLOIDORIENTATIONRECONSTRUCTION` (see Section 1.4). This algorithm constructs an orientation of the set of topes by choosing a pair  $v, \bar{v}$  of antipodal vertices in  $G$  and some shortest path from  $v$  to  $\bar{v}$ . For a canonical choice of the ground set, say  $E = \{1, \dots, n\}$  where  $n = \text{diam}(G)$ , the orientation is uniquely determined by the sequence of the  $n$  edges from  $v$  to  $\bar{v}$ . Let  $G$  and  $G'$  be tope graphs of oriented matroids. For  $G$  choose an antipodal pair  $v, \bar{v}$  and a shortest path  $p$  from  $v$  to  $\bar{v}$ . If  $G$  and  $G'$  are isomorphic or, equivalently, if  $G$  and  $G'$  are defined by oriented matroids from the same isomorphism class, then the diameter of  $G'$  equals the diameter of  $G$ , i.e.,  $n = \text{diam}(G) = \text{diam}(G')$ , and there exists a pair of antipodal vertices  $v', \bar{v}' \in V(G')$  and a shortest path  $p'$  from  $v'$  to  $\bar{v}'$  in  $G'$  such that algorithm `ACYCLOIDORIENTATIONRECONSTRUCTION` finds the same tope set from  $G$  using  $v, \bar{v}$  and  $p$  and from  $G'$  using  $v', \bar{v}'$  and  $p'$ . If  $G$  and  $G'$  are not isomorphic there are no such  $v', \bar{v}'$  and  $p'$ . Hence, it is sufficient for testing tope graph isomorphisms to check of all shortest paths  $p'$  between antipodal vertices  $v', \bar{v}'$  in  $G'$ . This leads to an algorithm which is quite efficient compared to general graph isomorphism tests.

## 4.2 Localizations and Tope Graph Extensions

This section discusses the single element extension problem and its relation to tope graphs in terms of localizations which has been illustrated already in Section 3.4. The present section discusses properties of localizations, where the following sections present algorithmic solutions to the localization generation problem, the problem to find all localizations of a given tope graph. As our main concern is the generation of isomorphism classes of oriented matroids, and since every isomorphism class can be represented by a simple oriented matroid, we restrict the following discussion to simple oriented matroids.

It will be helpful to introduce additional notation concerning *signatures* of graphs, i.e., maps of the form  $\sigma : V(G) \rightarrow \{-, +, 0\}$ . Every signature  $\sigma$  defines a partition on the vertex set  $V(G)$  by  $V^s := \{v \in V(G) \mid \sigma(v) = s\}$  for  $s \in \{-, +, 0\}$ . In addition we set  $V^\ominus := V^- \cup V^0$  and  $V^\oplus := V^+ \cup V^0$ . Furthermore, let  $G^-, G^+, G^0, G^\ominus$ , and  $G^\oplus$  denote the subgraphs of  $G$  induced by  $V^-, V^+, V^0, V^\ominus$ , and  $V^\oplus$ , respectively.

Consider two simple oriented matroids  $\mathcal{M} = (E, \mathcal{F})$  and  $\mathcal{M}' = (E', \mathcal{F}')$  with tope sets  $\mathcal{T}$  and  $\mathcal{T}'$ , respectively, such that  $\mathcal{M} = \mathcal{M}' \setminus f$ , i.e.,  $\mathcal{M}'$  is a single element extension of  $\mathcal{M}$ . Associating the tope graph  $G$  of  $\mathcal{M}$  to  $\mathcal{T}$  by  $\mathcal{L} : V(G) \rightarrow \mathcal{T}$ , the above single element extension defines a signature  $\sigma : V(G) \rightarrow \{-, +, 0\}$  on the vertex set of  $G$  by

$$\sigma(v) := \begin{cases} + & \text{if } T_E = \mathcal{L}(v) \text{ implies } T_f = + \text{ for } T \in \mathcal{T}', \\ - & \text{if } T_E = \mathcal{L}(v) \text{ implies } T_f = - \text{ for } T \in \mathcal{T}', \\ 0 & \text{otherwise} \end{cases}$$

for  $v \in V(G)$ . We then call  $\sigma$  *the localization of  $G$  w.r.t.  $\mathcal{L}$  and the single element extension  $\mathcal{M} \rightarrow \mathcal{M}'$* . It is clear that then  $\sigma$  determines the extended tope set  $\mathcal{T}'$  by

$$\mathcal{T}' := \{T \in \{+, -\}^{E \cup \{f\}} \mid \text{there exists } v \in V(G) \text{ s.t. } T_E = \mathcal{L}(v) \text{ and } \sigma(v) \in \{T_f, 0\}\}.$$

For any tope graph  $G$  of an oriented matroid, the property of a signature  $\sigma : V(G) \rightarrow \{-, +, 0\}$  being some localization of  $G$  or not is independent from the choice of  $\mathcal{M}$ ,  $\mathcal{L}$ , and  $\mathcal{M}'$  since  $G$  determines  $\mathcal{M}$  (and  $\mathcal{L}$ ) up to isomorphism and then  $\mathcal{M}'$  is determined by  $\mathcal{T}'$  as defined above:

**4.2.1 Definition (Localization of Tope Graph)** Let  $G$  be the tope graph of some oriented matroid. A signature  $\sigma : V(G) \rightarrow \{-, +, 0\}$  is called a *localization of  $G$*  if there exist  $\mathcal{M}$ ,  $\mathcal{L}$ , and  $\mathcal{M}'$  such that  $\sigma$  is the localization of  $G$  w.r.t.  $\mathcal{L}$  and the single element extension  $\mathcal{M} \rightarrow \mathcal{M}'$ .

The tope graph  $G'$  of the single element extension  $\mathcal{M}'$  is determined by  $G$  and  $\sigma$ :

**4.2.2 Proposition ([FH93])** *The tope graph of the single element extension  $\mathcal{M}'$  determined by  $G$  and a localization  $\sigma$  of  $G$  is a graph  $G'$  with vertex set*

$$\{v^- \mid v \in V^\ominus\} \cup \{v^+ \mid v \in V^\oplus\}$$

and edge set

$$\{\{v^-, v^+\} \mid v \in V^0\} \cup \{\{v^-, w^-\} \mid \{v, w\} \in E(G^\ominus)\} \cup \{\{v^+, w^+\} \mid \{v, w\} \in E(G^\oplus)\}.$$

We describe (sloppily) in words how the extended tope graph  $G'$  is obtained from  $G$  and  $\sigma$ . Every vertex  $v$  in  $V^0$  is split into two vertices  $v^-$  and  $v^+$  which are connected by an edge. We will see further below that there are no edges in  $G$  connecting  $V^-$  and  $V^+$ . Hence all edges from  $G$  are kept or doubled (if in  $E(G^0)$ ), where  $v^-$ -vertices ( $v^+$ -vertices) are connected to  $V^\ominus$ -vertices ( $V^\oplus$ -vertices) only, respectively.

**Proof of Proposition 4.2.2** Let  $G$  be the tope graph of an oriented matroid  $\mathcal{M} = (E, \mathcal{F})$  with associating bijection  $\mathcal{L}$  and tope set  $\mathcal{T}$ , furthermore let  $\sigma$  be a localization of  $G$  defining a single element extension  $\mathcal{M}' = (E \cup f, \mathcal{F}')$ . It is not difficult to see the correctness of the tope graph extension when considering the set  $\mathcal{T}'$  of extended topes. For every tope  $T' \in \mathcal{T}'$  there is a unique vertex  $v \in V(G)$  such that  $\mathcal{L}(v) = T'_E$ . If  $\sigma(v) = 0$  then also  $\overline{\mathcal{F}}T' \in \mathcal{T}'$ , and we split  $v$  into two vertices  $v^-, v^+ \in V(G')$ ; otherwise  $\mathcal{L}(v)$  is not cut by the new element  $f$  and we simply mark the corresponding vertex in  $V(G')$  by  $v^s$  according to  $s = \sigma(v) = T'_f$ . The set of edges in  $G'$  is determined by the fact that in simple oriented matroids (what we assumed) two vertices of the tope graph are adjacent if and only if the corresponding topes disagree in exactly one element (see Lemma 1.2.3). Hence there is an edge  $\{v^-, w^-\}$  (or  $\{v^+, w^+\}$ ) if and only if the corresponding vertices  $v, w$  have been adjacent in  $G$ , furthermore all vertices  $v^-, v^+$  coming from one split vertex will be adjacent in  $G'$ . ■

Before we state some important properties of localizations, remember the following fundamental facts about tope graphs of oriented matroids (see Section 1.2). Let  $G$  be the tope graph of a simple oriented matroid  $\mathcal{M}$  and  $\mathcal{L} : V(G) \rightarrow \mathcal{T}$  an associating bijection between the vertex set of  $G$  and the tope set of  $\mathcal{M}$ . Then the length of any shortest path  $x = u^0, \dots, u^d = y$  in  $G$  is  $d = |D(\mathcal{L}(x), \mathcal{L}(y))|$ , and then  $|D(\mathcal{L}(u^{i-1}), \mathcal{L}(u^i))| = 1$  for  $i \in \{1, \dots, d\}$  (see Proposition 1.2.4). For every vertex  $v \in V(G)$  there is a unique



vertex  $\bar{v} \in V(G)$  (called the antipode of  $v$ ) such that  $d_G(v, \bar{v}) = \text{diam}(G)$ , and then  $\mathcal{L}(\bar{v}) = -\mathcal{L}(v)$  (see Corollary 1.2.5).

A graph theoretical characterization of the localizations of a given tope graph is not known, but the following properties necessarily hold:

**4.2.3 Lemma ([FH93])** *Let  $G$  be the tope graph of an oriented matroid and  $\sigma : V(G) \rightarrow \{-, +, 0\}$  a localization of  $G$ . Then the following properties are valid:*

(L1)  $\sigma(\bar{v}) = -\sigma(v)$  for all  $v \in V(G)$ ,

(L2)  $E(G) \cap (V^- \times V^+) = \emptyset$ , and

(L3)  $d_{G^\ominus}(v, w) = d_G(v, w)$  for all  $v, w \in V^\ominus$ , and  $d_{G^\oplus}(v, w) = d_G(v, w)$  for all  $v, w \in V^\oplus$ .

**Proof** (L1) follows from the symmetry (A2) of tope sets, the definition of antipodes, and by Proposition 1.2.4 which implies that  $\mathcal{L}(\bar{v}) = -\mathcal{L}(v)$ .

For (L2) consider an edge  $\{v, w\} \in E(G)$  with  $\sigma(v) = -$  and  $\sigma(w) = +$ . The topes associated to  $v$  and  $w$ , say  $V, W \in \mathcal{T}$ , differ in exactly one sign  $g \in E$  (we are considering simple oriented matroids). The corresponding extended topes  $V', W'$  differ in exactly two signs,  $f$  and  $g$ . By the reorientation property (A1),  $\overline{f}V' \in \mathcal{T}'$  or  $\overline{g}V' = \overline{f}W' \in \mathcal{T}'$ , where the first would contradict  $\sigma(v) = -$  and the second  $\sigma(w) = +$ .

For (L3) consider  $v, w \in V^\ominus$  and the corresponding vertices  $v^-, w^- \in V(G')$ , where  $G'$  is the tope graph of the single element extension as discussed above. Remember for the following that by Proposition 1.2.4 the distance in tope graphs is characterized by the number of disagreeing elements of the corresponding topes. A shortest path  $p$  from  $v$  to  $w$  in  $G$  defines a corresponding path  $p'$  in  $G'$  between  $v^-$  and  $w^-$  which is again a shortest path by the above characterization. Furthermore, all vertices on  $p'$  correspond to topes  $T \in \mathcal{T}'$  with  $T_f = -$ , which is also implied by Proposition 1.2.4. Hence the given path  $p$  is contained in  $G^\ominus$ , which proves that  $d_{G^\ominus}(v, w) = d_G(v, w)$ . The analogous claim for  $G^\oplus$  follows similarly (or by symmetry). ■

In the proof of Lemma 4.2.3 we only needed properties of acycloids. In fact, properties (L1), (L2), and (L3) are characteristic for single element extensions of the tope graphs of acycloids (see [FH93]), where the extension of the tope graph of acycloids is determined as stated in Proposition 4.2.2 for localizations.

**4.2.4 Definition (Acycloidal Signature)** Let  $G$  be the tope graph of an oriented matroid. We call a signature  $\sigma$  of  $G$  an *acycloidal signature* of  $G$  if (L1), (L2), and (L3) are satisfied.

We strengthen the necessary properties of localizations using the separability of uncut topes (see Section 1.3):

**4.2.5 Theorem** *Let  $G$  be the tope graph of an oriented matroid and  $\sigma$  a localization of  $G$ . Then:*

(L4)  $G^-$  (and also  $G^+$ ) is a connected subgraph of  $G$ .

**Proof** Let  $\mathcal{M} = (E, \mathcal{F})$  be an oriented matroid with tope set  $\mathcal{T}$ , tope graph  $G$ , and associating bijection  $\mathcal{L} : V(G) \rightarrow \mathcal{T}$ . Let  $\mathcal{M}' = (E', \mathcal{F}')$  be the single element extension of  $\mathcal{M}$  defined by a given localization  $\sigma$  of  $G$ . Denote by  $\mathcal{T}'$  the tope set of  $\mathcal{M}'$  and by  $G'$  the tope graph of  $\mathcal{M}'$ . Then there exists  $f \in E'$  such that  $\mathcal{M} = \mathcal{M}' \setminus f$ , and there is a one-to-one correspondence between the topes in

$$\mathcal{T}'^- := \{T \in \mathcal{T}' \mid T_f = - \text{ and } \overline{f}T \notin \mathcal{T}'\}$$

and the vertices in  $V^-$ . By Theorem 1.3.1, the subgraph of  $G'$  induced by the vertices associated to  $\mathcal{T}'^-$  is connected, which implies that the subgraph  $G^-$  of  $G$  induced by the vertex set  $V^-$  is connected. Analogously (or by symmetry),  $G^+$  is connected. ■

We introduce two new notions of acycloidal signatures. The weaker notion will be used in the generation methods discussed in Sections 4.3 and 4.4; the property (L3) is not considered in the weaker notion since it will not be an invariant in the generation methods.

**4.2.6 Definition (Weak and Strong Acycloidal Signature)** Let  $G$  be the tope graph of an oriented matroid and  $\sigma$  a signature of  $G$ . We call  $\sigma$  a *weak acycloidal signature* of  $G$  if (L1), (L2), and (L4) are satisfied and a *strong acycloidal signature* of  $G$  if (L1), (L2), (L3), and (L4) are satisfied.

Because of the examples of Section 1.3 we know that strong acycloidal signatures do not characterize localizations of tope graphs of oriented matroids, but they are essential for the algorithmic methods of the following sections. In fact, these generation algorithms have been the motivation to investigate stronger properties of localizations which lead to the result of Theorem 1.3.1 and Theorem 4.2.5. On the other hand there are algorithmic characterizations of localizations of tope graphs:

**4.2.7 Proposition** *Localizations of tope graphs of oriented matroids can be verified in polynomial time.*

**Proof** Since the extended tope graph can be constructed easily from a tope graph and a localization as described in Proposition 4.2.2, the claim is a clear consequence of Corollary 1.7.2. ■

In the incremental method for the generation of isomorphism classes of oriented matroids (see Section 3.3) we described that a single element extension may or may not increase the rank of the oriented matroid, and it is worth noting that the two cases (rank increases or stays) can be recognized easily from the localization:

**4.2.8 Lemma** *Let  $G$  be the tope graph of an oriented matroid  $\mathcal{M}$  and  $\sigma$  a localization of  $G$ . The rank of a single element extension  $\mathcal{M}'$  according to  $G$  and  $\sigma$  is the same as the rank of  $\mathcal{M}$  unless  $\sigma(v) = 0$  for all  $v \in V(G)$ , then  $\text{rank}(\mathcal{M}') = \text{rank}(\mathcal{M}) + 1$ .*

**Proof** Let  $G$  be the tope graph of an oriented matroid  $\mathcal{M}$  with associating bijection  $\mathcal{L} : V(G) \rightarrow \mathcal{T}$ , and  $\sigma$  a localization of  $G$ , defining a single element extension  $\mathcal{M}'$  of  $\mathcal{M}$ , where  $f$  is the new element. By Corollary 0.4.9 (i), the rank of  $\mathcal{M}'$  is the same as the rank of  $\mathcal{M}$  unless  $f$  is a coloop of  $\mathcal{M}'$ , and then then  $\text{rank}(\mathcal{M}') = \text{rank}(\mathcal{M}) + 1$ . We prove that  $f$  is a coloop of  $\mathcal{M}'$  if and only if  $\sigma(v) = 0$  for all  $v \in V(G)$ . Let  $\mathcal{D}'$  denote the set of cocircuits of  $\mathcal{M}'$ . If  $f$  is a coloop of  $\mathcal{M}'$ , by composition of the corresponding cocircuits  $X, -X \in \mathcal{D}'$  with  $\underline{X} = \{f\}$  and any tope  $T \in \mathcal{T}'$ ,  $\overline{f}T \in \mathcal{T}'$ , which shows that  $\sigma(v) = 0$  for all  $v \in V(G)$ . On the other hand, if  $\sigma(v) = 0$  for all  $v \in V(G)$  then  $\overline{f}T \in \mathcal{T}'$  for all  $T \in \mathcal{T}'$ , and by Proposition 0.7.3 there is a cocircuit  $X \in \mathcal{D}'$  with  $\underline{X} = \{f\}$ , i.e.,  $f$  is a coloop of  $\mathcal{M}'$ , what completes the claim. ■

### 4.3 Reverse Search Method for the Generation of Localizations

Let  $G$  be the tope graph of some oriented matroid  $\mathcal{M} = (E, \mathcal{F})$ ; the goal of this section is to find all tope graphs of single element extensions of  $\mathcal{M}$  up to graph isomorphism (which is equivalent to finding all single element extensions up to oriented matroid isomorphism). Note that our method is working with graphs and not with sets of sign vectors. The main idea is to generate first all weak acycloidal signatures and then to test these signatures for being strong acycloidal signatures, finally for being localizations (again in polynomial time, see Proposition 4.2.7). The tope graphs of the extended oriented matroids (or, more generally, of the extended acycloids) are easily obtained from the localizations (as determined in Proposition 4.2.2), and finally graph isomorphism checking (see Section 4.1) leads to a set of representatives up to isomorphism.

The first step in our method is the generation of all weak acycloidal signatures of a given tope graph  $G$ . Property (L4) is essential for our method as it makes it possible to generate all weak acycloidal signatures of  $G$  without repetition. Note that our algorithms cannot be restricted to strong acycloidal signatures since property (L3) is not an invariant in the generation process and hence the generation would become incomplete. For the generation we modify a reverse search method for the generation of all connected subgraphs of a given graph [AF96]. Enumerate the vertices of the given tope graph  $G$  in an arbitrary way such that  $V(G) = \{1, \dots, f_d\}$ . Remember that every weak acycloidal signature  $\sigma$  defines a set  $V^- := \{v \in V(G) \mid \sigma(v) = -\}$ , and the subgraph  $G^-$  of  $G$  induced by the vertices in  $V^-$  is connected.

For the reverse search method we define a directed graph  $\mathcal{G}$  as follows (in the language of the original reference [AF96], the directed edges of  $\mathcal{G}$  define a local search function): The vertices of  $\mathcal{G}$  are the weak acycloidal signatures of  $G$ ; there is for every weak acycloidal signature  $\sigma$  with  $V^- \neq \emptyset$  exactly one directed edge  $(\sigma \rightarrow \tau) \in E(\mathcal{G})$ , where  $\tau$  is defined as follows: Let  $V^-$  be defined by  $\sigma$ , and let  $u \in V^-$  be the smallest vertex such that the subgraph of  $G$  induced by  $V^- \setminus \{u\}$  remains connected ( $u$  obviously exists); then let  $\tau$  be the signature with  $\tau(w) = \sigma(w)$  for  $w \in V(G) \setminus \{v, \bar{v}\}$  and  $\tau(v) = \tau(\bar{v}) = 0$  (then  $\tau$  is a weak acycloidal signature). There is a unique sink in  $\mathcal{G}$ , namely the signature with

$\sigma(v) = 0$  for all  $v \in V(G)$ , and every vertex in  $\mathcal{G}$  is connected to the sink. The search starts with the sink of  $\mathcal{G}$  and exploits  $\mathcal{G}$  by traversing the edges in reversed direction: By this all weak acycloidal signatures of  $G$  can be found without repetition. A description of the algorithm WEAKACYCLOIDALSIGNATURESREVERSESEARCH is given in Pseudo-Code 4.1. Note that (different from the simple presentation here) it is not necessary in the reverse search method to store the output list (here: in  $\mathcal{W}$ ); furthermore the method is parallelizable.

*Input:* The tope graph  $G$  of an oriented matroid.

*Output:* A list  $\mathcal{W}$  of all weak acycloidal signatures of  $G$ .

```

begin WEAKACYCLOIDALSIGNATURESREVERSESEARCH( $G$ );
  determine all antipodes in  $G$ ;
  let  $\sigma$  be the signature with  $\sigma(v) = 0$  for all  $v \in V(G)$ ;
   $\mathcal{W} := \{\sigma\}$ ;  $\mathcal{W}_{\text{new}} := \{\sigma\}$ ;
  while  $\mathcal{W}_{\text{new}} \neq \emptyset$  do
    take any  $\tau \in \mathcal{W}_{\text{new}}$  and remove  $\tau$  from  $\mathcal{W}_{\text{new}}$ ;
    for all  $v \in V(G)$  with  $\tau(v) = 0$  do
      if there is no  $\{v, w\} \in E(G)$  with  $\sigma(w) = +$  or  $w = \bar{v}$  and
        there is  $\{v, w\} \in E(G)$  with  $\sigma(w) = -$  then
           $\sigma := \tau$ ;  $\sigma(v) := -$ ;  $\sigma(\bar{v}) := +$ ;
          determine  $V^-$  from  $\sigma$ ;
          find the smallest  $u \in V^-$  such that
            the subgraph induced by  $V^- \setminus \{u\}$  is connected;
          if  $u = v$  then  $\mathcal{W} := \mathcal{W} \cup \{\sigma\}$ ;  $\mathcal{W}_{\text{new}} := \mathcal{W}_{\text{new}} \cup \{\sigma\}$  endif
        endif
      endfor
    endwhile;
  return  $\mathcal{W}$ 
end WEAKACYCLOIDALSIGNATURESREVERSESEARCH.

```

Pseudo-Code 4.1: Algorithm WEAKACYCLOIDALSIGNATURESREVERSESEARCH

**4.3.1 Proposition** *Algorithm WEAKACYCLOIDALSIGNATURESREVERSESEARCH determines the set of all weak acycloidal signatures of  $G$  in time of at most  $O(\ell \cdot f_d^2 f_{d-1})$ , where  $\ell$  is the number of weak acycloidal signatures of  $G$  and  $f_d = |V(G)|$  and  $f_{d-1} = |E(G)|$ .*

**Proof** Note that every weak acycloidal signature of  $G$  is added exactly once to  $\mathcal{W}_{\text{new}}$ , and for every graph  $G$  it can be tested in time  $O(|E(G)|)$  whether  $G$  is connected. ■

## 4.4 Reduction of Multiple Extension Using Isomorphic Signatures

In this section we discuss a method for the generation of weak acycloidal localizations which is similar to the method of the previous section. The difference is that we try to reduce multiple generation of isomorphic extensions at an early stage. The key observation used in the following is:

**4.4.1 Lemma** *Two localizations  $\sigma$  and  $\tau$  of a tope graph  $G$  lead to isomorphic extensions if there is a graph automorphism  $g \in \text{Aut}(G)$  such that  $\sigma = \tau g$ , i.e.,  $\sigma(v) = \tau(g(v))$  for all  $v \in V(G)$ .*

**Proof** The claim is a straightforward implication of the fact that the isomorphism class of an oriented matroid is determined by its tope graph (see Corollary 1.4.2 and the discussion in Section 4.1). ■

**4.4.2 Definition** Two signatures  $\sigma, \tau : V(G) \rightarrow \{-, +, 0\}$  of a graph  $G$  are called *isomorphic* if there exists a graph automorphism  $g \in \text{Aut}(G)$  such that  $\sigma = \tau g$ .

A direct application of isomorphic signatures is a more efficient isomorphism checking for a set of extended tope graphs. Instead of testing all extended tope graphs against each other (e.g., using a method as described at the end of Section 4.1), the localizations (or weak acycloidal localizations) are tested first for being isomorphic signatures. Practically all automorphisms of  $G$  can be computed in advance which makes it very fast to reduce a list of signatures such that no two remaining signatures are isomorphic. Note that testing for isomorphic signatures is not sufficient for testing for isomorphic extensions: there are non-isomorphic localizations of some tope graphs which lead to isomorphic single element extensions.

We present in the following a variant of the algorithm WEAKACYCLOIDALSIGNATURES-REVERSESEARCH which generates weak acycloidal signatures only up to isomorphism (in the sense of Definition 4.4.2), i.e., exactly one representative of each isomorphism class is returned from the list of all weak acycloidal signatures. This new algorithm WEAKACYCLOIDALSIGNATURESUPTOISOMORPHISM does not use reverse search, but still can be more efficient than the reverse search method as checking for isomorphic signatures will avoid the generation of many subtrees in the search tree.

As before, the generation of signatures starts with  $\sigma : V(G) \rightarrow 0$ , i.e.,  $V^- = \emptyset$ , and then augments  $V^-$  by adding single vertices, but now not only with “minimal” vertices as in the reverse search method. We say that a signature  $\sigma$  is an *augmentation* of a weak acycloidal signature  $\tau$  w.r.t.  $v \in V(G)$  if  $\sigma$  is a weak acycloidal signature and  $\sigma(w) = \tau(w)$  for all  $w \in V(G) \setminus \{v, \bar{v}\}$ ,  $\sigma(v) = -$ , and  $\tau(v) = 0$ . The augmentations are generated with increasing cardinality  $|V^-| = k$ , and for every  $k$  only one representative of every isomorphism class is kept for further augmentations. This leads to an algorithm WEAKACYCLOIDALSIGNATURESUPTOISOMORPHISM as described in Pseudo-Code 4.2; the correctness follows from the following inductive argument:

**4.4.3 Lemma** *Let  $G$  be the tope graph of an oriented matroid. Consider the set  $\mathcal{W}_k$  of all weak acycloidal signatures of  $G$  with  $|V^-| = k$  for an integer  $k \geq 0$ . Let  $\mathcal{W}_k^*$  be a set containing exactly one representative of every isomorphism class of  $\mathcal{W}_k$ . Define  $\mathcal{W}'_{k+1}$  as the set of all augmentations of signatures in  $\mathcal{W}_k^*$ , and let  $\mathcal{W}_{k+1}^*$  be a set containing exactly one representative of every isomorphism class of  $\mathcal{W}'_{k+1}$ . Then:  $\mathcal{W}_{k+1}^*$  contains a representative of every isomorphism class of the set  $\mathcal{W}_{k+1}$  of all weak acycloidal signatures of  $G$  with  $|V^-| = k + 1$ .*

**Proof** Let  $G$ ,  $\mathcal{W}_k$ ,  $\mathcal{W}_k^*$ ,  $\mathcal{W}'_{k+1}$ ,  $\mathcal{W}_{k+1}^*$ , and  $\mathcal{W}_{k+1}$  be as described above. Consider an arbitrary  $\sigma \in \mathcal{W}_{k+1}$ . We have to show that there exists a signature  $\sigma^* \in \mathcal{W}_{k+1}^*$  which is isomorphic to  $\sigma$ . Take any  $\tau \in \mathcal{W}_k$  such that  $\sigma$  is an augmentation of  $\tau$  (obviously  $\tau$  exists) w.r.t. to some vertex  $v \in V(G)$ . Then there exists  $\tau^* \in \mathcal{W}_k^*$  such that  $\tau = \tau^*g$  for some  $g \in \text{Aut}(G)$ . As  $g$  is a graph automorphism and all properties of weak acycloidal signatures are preserved under graph automorphisms, there is  $\sigma' \in \mathcal{W}'_{k+1}$  which is augmentation of  $\tau^*$  w.r.t.  $g(v)$ , therefore  $\sigma = \sigma'g$ :  $\sigma$  and  $\sigma'$  are isomorphic. Since some signature  $\sigma^* \in \mathcal{W}_{k+1}^*$  is isomorphic to  $\sigma'$ , the claim follows. ■

*Input:* A tope graph  $G$  of an oriented matroid.

*Output:* A list  $\mathcal{W}^*$  of all weak acycloidal signatures of  $G$  up to isomorphism.

**begin** WEAKACYCLOIDALSIGNATURESUPTOISOMORPHISM( $G$ );

  let  $\sigma$  be the signature with  $\sigma(v) = 0$  for all  $v \in V(G)$ ;

$\mathcal{W}^* := \{\sigma\}$ ;  $\mathcal{W}_0^* := \{\sigma\}$ ;  $k := 0$ ;

**while**  $\mathcal{W}_k^* \neq \emptyset$  **do**

$\mathcal{W}'_{k+1} :=$  the set of all augmentations of signatures in  $\mathcal{W}_k^*$ ;

$\mathcal{W}_{k+1}^* :=$  a set of representatives of the isomorphism classes of  $\mathcal{W}'_{k+1}$ ;

$\mathcal{W}^* := \mathcal{W}^* \cup \mathcal{W}_{k+1}^*$ ;

$k := k + 1$

**endwhile**;

**return**  $\mathcal{W}^*$

**end** WEAKACYCLOIDALSIGNATURESUPTOISOMORPHISM.

Pseudo-Code 4.2: Algorithm WEAKACYCLOIDALSIGNATURESUPTOISOMORPHISM

As stated above, we do not use reverse search for algorithm WEAKACYCLOIDALSIGNATURESUPTOISOMORPHISM, and the reason may be seen when considering the proof of Lemma 4.4.3: In a reverse search method the augmenting vertices have to satisfy a minimal property, so in the inductive argument both  $v$  and  $g(v)$  have to be minimal, which is not true in general. Still it may be possible that WEAKACYCLOIDALSIGNATURESUPTOISOMORPHISM can be combined with the reverse search method (e.g., using a special choice for the representatives of isomorphism classes).

## 4.5 Reduction of Multiple Extension Using Maximal Localizations

The two previous sections presented two algorithms for the generation of weak acycloidal localizations (up to isomorphism), namely WEAKACYCLOIDALSIGNATURESREVERSESEARCH and WEAKACYCLOIDALSIGNATURESUPTOISOMORPHISM. This section discusses further improvements, mainly considering the multiple extension reduction problem (see Section 3.3) for which we present a simple heuristic which is quite efficient in practice.

In the incremental method described in Chapter 3 every oriented matroid  $\mathcal{M} = (E, \mathcal{F})$  is obtained as a single element extension of some deletion minor. Usually  $\mathcal{M}$  has several (up to  $|E|$ ) non-isomorphic deletion minors, but only one is needed to generate  $\mathcal{M}$ . In the following we restrict our method to extensions of deletion minors with a minimal number of topes; this will eliminate many but not all multiplicities in the method. Furthermore—we will describe this in the following—it can be checked from tope graphs and signatures whether the extension comes from a minor with a minimal number of topes, and this criterion will reduce the amount of enumeration of weak acycloidal signatures.

Consider an oriented matroid  $\mathcal{M}'$  and a deletion minor  $\mathcal{M}' \setminus f$ , which defines a localization  $\sigma$  of the tope graph  $G$  of  $\mathcal{M}' \setminus f$ . The number of topes of  $\mathcal{M}' \setminus f$  is minimal among all deletion minors of  $\mathcal{M}'$  if and only if the difference of the numbers of topes of  $\mathcal{M}' \setminus f$  and  $\mathcal{M}'$  is maximal:

**4.5.1 Definition (Maximal Localization)** Let  $G$  be the tope graph of an oriented matroid  $\mathcal{M} = (E, \mathcal{F})$  and  $\sigma$  a weak acycloidal signature of  $G$  which defines a single element extension  $\mathcal{T}'$  (defined as in Section 4.2 for localizations) with tope graph  $G'$  and new element  $f$ . We call  $\sigma$  a *maximal localization of  $G$*  if  $|\mathcal{T}'| - |\mathcal{T}' \setminus f| \geq |\mathcal{T}'| - |\mathcal{T}' \setminus e|$  for all  $e \in E$  or, equivalently, if  $|\mathcal{T}' \setminus f| \leq |\mathcal{T}' \setminus e|$  for all  $e \in E$ . If  $\mathcal{T}'$  is the set of topes of an oriented matroid  $\mathcal{M}'$  then the set of topes of  $\mathcal{M}' \setminus e$  is  $\mathcal{T}' \setminus e$  for  $e \in E \cup f$ .

For the following characterization of maximal localizations remember the notion of *edge classes* (see Definition 1.2.7 and Lemma 1.2.8): Let  $G$  be the tope graph of an oriented matroid  $\mathcal{M}$ . The relation  $\sim$  defined on the set of edges  $E(G)$  by  $\{v, w\} \sim \{v', w'\}$  if  $d_G(v', v) < d_G(v', w)$  and  $d_G(w', w) < d_G(w', v)$  is an equivalence relation and leads to a partition of  $E(G)$  into edge classes  $E^e$  which correspond to the elements in the ground set of  $\mathcal{M}$ .

**4.5.2 Lemma** Let  $G$  be the tope graph of an oriented matroid  $\mathcal{M} = (E, \mathcal{F})$  and  $\sigma$  a localization of  $G$ ; as usual set  $V^0 := \{v \in V(G) \mid \sigma(v) = 0\}$ . Then  $\sigma$  is a maximal localization of  $G$  if and only if for every edge class  $E^e \subseteq E(G)$

$$(M) \quad |V^0| \geq |E^e| + |E^e \cap (V^0 \times V^0)|.$$

**Proof** Let  $G, \mathcal{M} = (E, \mathcal{F}), \sigma, \mathcal{T}', G'$ , and  $f$  be as in the definition of maximal localizations. Consider the differences  $|\mathcal{T}'| - |\mathcal{T}' \setminus e|$  of number of topes for  $e \in E \cup f$ . For  $e = f$

this difference obviously is  $|V^0|$ . For  $e \neq f$  the difference equals the number of edges in the corresponding edge class  $(E^e)'$  of the extended tope graph  $G'$  or, equivalently, half of the number of topes  $T' \in \mathcal{T}'$  for which  $\overline{e}T' \in \mathcal{T}'$ . This number can be computed from half of the number of topes  $T \in \mathcal{T}' \setminus f$  for which  $\overline{e}T \in \mathcal{T}' \setminus f$ , which is  $|E^e|$ , where every such tope  $T$  counts twice if  $T$  and  $\overline{e}T$  are cut by  $f$ : the number of topes which count twice is  $|E^e \cap (V^0 \times V^0)|$ . Hence  $|\mathcal{T}'| - |\mathcal{T}' \setminus e| = |E^e| + |E^e \cap (V^0 \times V^0)|$  for  $e \in E$ , which proves the claim. ■

If (M) is not valid for some weak acycloidal signature  $\sigma$ , then (M) is also violated for every augmentation of  $\sigma$ : An augmentation will decrease  $|V^0|$  by 2 and  $|E^e \cap (V^0 \times V^0)|$  by at most 2 (note that edges incident to a common vertex belong to different edge classes). Therefore signatures which violate (M) can be discarded in the generation algorithms, and by this the amount of enumeration is reduced considerably.

We conclude this section with a remark on how the algorithms presented above may be slightly improved when considering strong acycloidal signatures instead of weak acycloidal signatures. We modify the two algorithms WEAKACYCLOIDALSIGNATURESREVERSESEARCH and WEAKACYCLOIDALSIGNATURESUPTOISOMORPHISM by adding a simple test: When for a signature  $\sigma$  there exist vertices  $v, w \in V^-$  such that  $d_{G^\ominus}(v, w) > d_G(v, w)$ , then neither  $\sigma$  nor any augmentations of  $\sigma$  will satisfy (L3), i.e., we will discard such signatures in the algorithms (for the augmentations observe that  $d_G(v, w)$  does not change and  $d_{G^\ominus}(v, w)$  will not decrease since  $V^\ominus$  becomes smaller as  $V^+$  becomes larger).



## Chapter 5

# Cocircuit Graphs and Single Element Extensions

This chapter presents methods based on cocircuit graphs of oriented matroids which solve the single element extension problem of oriented matroids, discussed in the context of the isomorphism class generation problem of oriented matroids. For the problem statements and an overview of the approach see Chapter 3. In contrast to tope graphs, cocircuit graphs do not characterize the isomorphism classes of oriented matroids. However, as a result of Las Vergnas [LV78b], the single element extensions of an oriented matroid can be characterized by the cocircuit graph together with a corresponding list of coline cycles. This enables us to design efficient algorithmic solutions for the generation problem of oriented matroids.

### 5.1 Cocircuit Graphs and Isomorphism Classes of Oriented Matroids

We discuss in this section the connections between cocircuit graphs and isomorphism classes of oriented matroids, similar as in Section 4.1 for tope graphs.

Let  $G$  be the cocircuit graph of an oriented matroid  $\mathcal{M}$ , and  $\mathcal{L} : V(G) \rightarrow \mathcal{D}$  a bijection which associates vertices with cocircuits. In the language of graph labels (see Section 2.1) we call  $\mathcal{L}$  an OM-label of  $G$  and  $L : V(G) \rightarrow \mathcal{H}$  defined by  $L(v) := \mathcal{L}(v)^0$  for  $v \in V(G)$  the M-label induced by  $\mathcal{L}$ ; remember that  $\mathcal{H}$  denotes the set of hyperplanes (here, of the underlying matroid  $\underline{\mathcal{M}}$ ). By Corollary 2.2.8,  $\mathcal{M}$  is determined by  $G$  and the M-label  $L$  up to reorientation, and clearly also every oriented matroid in the reorientation class  $\text{OC}(\mathcal{M})$  has  $G$  as its cocircuit graph with M-label  $L$ . Furthermore, the discussion of algorithm OMLABELFROMMLABEL (see Theorem 2.2.7) shows that  $\mathcal{L}$  is determined up to reorientation by  $G$  and  $L$ , i.e., if  $\mathcal{L}$  and  $\mathcal{L}'$  are two associating bijections from  $V(G)$

to sets of cocircuits  $\mathcal{D}$  and  $\mathcal{D}'$  of oriented matroids  $\mathcal{M}$  and  $\mathcal{M}'$ , respectively, where  $\mathcal{L}$  and  $\mathcal{L}'$  induce the same M-label  $L$ , then there exists a reorientation  $\rho$  such that  $\mathcal{L} = \rho\mathcal{L}'$ . As before, we denote the concatenation of maps  $\rho, \sigma$  by  $\rho\sigma$  ( $\rho$  after  $\sigma$ ), and the inverse of a bijection  $\tau$  by  $\tau^{-1}$ .

Instead of reorientation classes of oriented matroids, which we have considered above, let us have a closer look at isomorphism classes. We may consider for a moment simple oriented matroids only, i.e., we assume that there are no parallel elements  $e \neq f$  and no loops, by this excluding trivial isomorphisms as we did in the discussion concerning tope graphs (see Section 4.1). As introduced in Definition 4.1.1, let  $\text{Aut}(\mathcal{M})$  be the set of automorphisms of a simple oriented matroid  $\mathcal{M} = (E, \mathcal{F})$ , i.e.,  $\phi = \rho\pi$  with  $\rho$  a reorientation and  $\pi$  a permutation on  $E$  belongs to  $\text{Aut}(\mathcal{M})$  if  $\mathcal{F} = \{\phi(X) \mid X \in \mathcal{F}\}$ . Similar to tope graphs, there is a strong relation between  $\text{Aut}(\mathcal{M})$  and certain of the graph automorphisms of the cocircuit graph of  $G$ , as we discuss in the following (we refer to [Asc00] for the notions of groups and group isomorphisms).

**5.1.1 Definition (Cocircuit Graph Automorphism,  $\text{Aut}(G, L)$ )** Let  $G$  be a cocircuit graph of an oriented matroid with M-label  $L$ . An automorphism  $g \in \text{Aut}(G)$  is called a *cocircuit graph automorphism of  $G$  and  $L$*  if there exists a permutation  $\pi$  of the ground set  $E$  (given as the union of all vertex labels defined by  $L$ ) such that  $Lg = \pi L$ . The set of all cocircuit graph automorphisms of  $G$  and  $L$  is denoted by  $\text{Aut}(G, L)$ .

**5.1.2 Proposition** Let  $\mathcal{M}$  be a simple oriented matroid with cocircuit graph  $G$  and  $L$  the M-label of  $G$  induced by an associating bijection  $\mathcal{L} : V(G) \rightarrow \mathcal{D}$ , where  $\mathcal{D}$  is the set of cocircuits of  $\mathcal{M}$ . Then  $\text{Aut}(G, L)$  and  $\text{Aut}(\mathcal{M})$  are isomorphic groups.

**Proof** Let  $\mathcal{M}$  be a simple oriented matroid with cocircuit graph  $G$  and associating bijection  $\mathcal{L} : V(G) \rightarrow \mathcal{D}$ . Let  $L$  be the M-label of  $G$  induced by  $\mathcal{L}$ .

- $\phi_g := \mathcal{L}g\mathcal{L}^{-1} \in \text{Aut}(\mathcal{M})$  for every  $g \in \text{Aut}(G, L)$ : Since  $g$  is a cocircuit graph automorphism of  $G$  and  $L$  there exist a permutation  $\pi$  of the ground set  $E$  such that  $Lg = \pi L$ . By Theorem 2.2.7,  $\mathcal{M}$  is determined by  $G$  and the M-label  $L$  up to reorientation, i.e., there exists a reorientation  $\rho$  such that  $\mathcal{L}g = \rho\pi\mathcal{L}$ . For  $\phi := \rho\pi \in \text{Aut}(\mathcal{M})$ ,  $\mathcal{L}g = \phi\mathcal{L}$ , hence  $\phi_g = \mathcal{L}g\mathcal{L}^{-1} = \phi \in \text{Aut}(\mathcal{M})$ .
- $g_\phi := \mathcal{L}^{-1}\phi\mathcal{L} \in \text{Aut}(G, L)$  for every  $\phi \in \text{Aut}(\mathcal{M})$ : By definition of cocircuit graphs, which is independent from oriented matroid isomorphisms,  $g_\phi \in \text{Aut}(G)$ . Furthermore,  $Lg_\phi = \pi L$  for  $\phi = \rho\pi$ .
- $g \mapsto \phi_g$  and  $\phi \mapsto g_\phi$  are inverse to each other, which follows by definition. Hence these maps establish bijections between  $\text{Aut}(G, L)$  and  $\text{Aut}(\mathcal{M})$ . Furthermore

$$\phi_{gh} = \mathcal{L}gh\mathcal{L}^{-1} = \mathcal{L}g\mathcal{L}^{-1}\mathcal{L}h\mathcal{L}^{-1} = \phi_g\phi_h$$

for all  $g, h \in \text{Aut}(G, L)$ , and

$$g_{\phi\psi} = \mathcal{L}^{-1}\phi\psi\mathcal{L} = \mathcal{L}^{-1}\phi\mathcal{L}\mathcal{L}^{-1}\psi\mathcal{L} = g_\phi g_\psi$$

for all  $\phi, \psi \in \text{Aut}(\mathcal{M})$ . ■

**Open Problem:**  $\text{Aut}(G) = \text{Aut}(G, L)$  for all cocircuit graphs  $G$  and for all  $M$ -labels  $L$  of  $G$ ?

If  $\text{Aut}(G) = \text{Aut}(G, L)$  for all cocircuit graphs  $G$  and all  $M$ -labels  $L$  of  $G$  then Proposition 4.1.2 implies that for every oriented matroid the automorphism groups of the cocircuit graph and of the tope graph are isomorphic. Furthermore, an answer to the above open problem would also solve Open Problem 1 in Section 2.6.

The isomorphism class of an oriented matroid is represented by its  $M$ -labeled cocircuit graph, where the  $M$ -label is considered up to isomorphism. This representation can be used to test rather efficiently whether two oriented matroids are isomorphic (this is the isomorphism checking problem of oriented matroids, see Section 3.3) as we discuss in the following. Let  $G$  and  $G'$  be cocircuit graphs of oriented matroids with  $M$ -labels  $L$  and  $L'$ , respectively. If  $G$  and  $G'$  are defined by oriented matroids from the same isomorphism class then  $G$  and  $G'$  are isomorphic and there exists a bijection  $g : V(G) \rightarrow V(G')$  such that  $L'g = \phi L$  for some isomorphism  $\phi$  on the ground sets; we call such a  $g$  a *cocircuit graph isomorphism from  $G$  to  $G'$* .

In the following algorithm, *coline cycles* play a major role. Coline cycles have been introduced in Section 2.2 (Definition 2.2.4): Let  $\mathcal{M} = (E, \mathcal{F})$  be an oriented matroid with  $\text{rank}(\mathcal{M}) \geq 2$  and  $G$  the cocircuit graph of  $\mathcal{M}$  with associating bijection  $\mathcal{L} : V(G) \rightarrow \mathcal{D}$ . For an edge  $\{v, w\} \in E(G)$  the set  $U := \mathcal{L}(v)^0 \cap \mathcal{L}(w)^0 \subseteq E$  is a coline of the underlying matroid  $\underline{\mathcal{M}}$ , which is called *the coline of  $\{v, w\}$* . By Lemma 2.2.3, the edges in  $E(G)$  of coline  $U$  form a cycle  $c(U)$  in  $G$  which we call *the coline cycle of  $U$* .

The algorithmic idea is to find a cocircuit graph isomorphism  $g$  from  $G$  to  $G'$  by enumeration of a number of bijections  $V(G) \rightarrow V(G')$ , using a backtracking technique on the set of vertices of  $G$ . Start with some vertex  $v \in V(G)$ . For all  $v' \in V(G')$  try out whether  $g(v) = v'$  can be extended to a cocircuit graph isomorphism  $g$  from  $G$  to  $G'$ . For this fix an arbitrary neighbor  $w$  of  $v$ . For all neighbors  $w'$  of  $v'$  in  $G'$  try out whether  $g(w) = w'$  can be extended to cocircuit graph isomorphism  $g$  from  $G$  to  $G'$ . For this observe that  $L$ ,  $v$ , and  $w$  determine a coline cycle in  $G$ , and this has to correspond to the coline cycle determined by  $L'$ ,  $v'$ , and  $w'$  in  $G'$ : the choice of  $g(v)$  and  $g(w)$  defines  $g(x)$  for all vertices in the coline cycle. If a second neighbor  $u$  of  $v$  is chosen, any choice of  $g(u)$  in  $G'$  fixes a second coline cycle. Furthermore, there may be other coline cycles for which some of the vertices have been considered already, and recursively this determines more and more vertices: only a few vertices suffice and the bijection  $g$  is determined. It is then trivial to test whether there exists an isomorphism  $\phi$  on the ground set such that  $L'g = \phi L$ . Of course the enumeration process can be enhanced by adding some simple tests such as whether the degree of vertices  $x$  and  $g(x)$  is equal, whether coline cycles in  $G$  and  $G'$  have same length if necessary, or whether there exist isomorphisms  $\phi$  for partially defined  $g$ . Whenever such a test fails the current choice is skipped in the enumeration.

The efficiency of the above isomorphism test depends on the rank of the corresponding oriented matroids: the higher the rank the slower the algorithm. The reason for this observation lies in the connectivity of coline cycles, which was studied in Section 2.3 for uniform oriented matroids. For example, in the cocircuit graph of an oriented matroid of rank 3 every coline cycle intersects every other, and it suffices in the above algorithm

to consider three vertices ( $v$  and two neighbors), independent from the cardinality of the ground set. In higher rank we have to consider a correspondingly higher number of vertices.

## 5.2 Localizations and Cocircuit Graph Extensions

In this section we consider cocircuit graphs of oriented matroids and their relation to single element extensions of oriented matroids. We have introduced in Section 3.4 localizations of cocircuit graphs which represent single element extensions; we discuss this here in more detail.

Consider two oriented matroids  $\mathcal{M} = (E, \mathcal{F})$  and  $\mathcal{M}' = (E', \mathcal{F}')$  with cocircuit sets  $\mathcal{D}$  and  $\mathcal{D}'$ , respectively, where  $E' = E \cup \{f\}$  for  $f \notin E$ . Furthermore assume that  $\mathcal{M} = \mathcal{M}' \setminus f$ , i.e.,  $\mathcal{M}'$  is a single element extension of  $\mathcal{M}$ . We assume for the following that  $f$  is not a coloop of  $\mathcal{M}'$ : extensions by coloops will not be represented by localizations of cocircuit graphs, hence all single element extensions considered in the following do not increase the rank of the oriented matroid (note that by Lemma 3.3.2 these extensions are not necessary for a complete generation of oriented matroids).

**5.2.1 Lemma** *For every cocircuit  $X \in \mathcal{D}$  there exists a unique cocircuit  $X' \in \mathcal{D}'$  such that  $X = X' \setminus f$ .*

**Proof** Let be  $X \in \mathcal{D}$ . By definition of the deletion minor there exists some  $X' \in \mathcal{F}'$  such that  $X = X' \setminus f$ . Since  $f$  is not a coloop,  $r := \text{rank}(\mathcal{M}) = \text{rank}(\mathcal{M}')$ . By Corollary 0.4.9 (iii),  $\text{rank}_{\mathcal{M}}(X) = \text{rank}_{\mathcal{M}'}(X')$  or  $\text{rank}_{\mathcal{M}}(X) = \text{rank}_{\mathcal{M}'}(X') + 1$ , where the latter would imply  $X' = \mathbf{0}$ , which is not possible because of  $X = X' \setminus f \neq \mathbf{0}$ . Therefore,  $X' \in \mathcal{D}'$ . For the proof of the uniqueness consider  $Y' \in \mathcal{D}'$  with  $X = Y' \setminus f$ . Then at least one of  $\underline{X'} \subseteq \underline{Y'}$  or  $\underline{Y'} \subseteq \underline{X'}$  is valid, and by cocircuit axiom (C2) and  $X \neq \mathbf{0}$ ,  $X' = Y'$ . ■

Associating the cocircuit graph  $G$  of  $\mathcal{M}$  to  $\mathcal{D}$  by  $\mathcal{L} : V(G) \rightarrow \mathcal{D}$ , the above single element extension defines a signature  $\sigma : V(G) \rightarrow \{-, +, 0\}$  on the vertex set of  $G$  by  $\sigma(v) := X'_f$  for  $v \in V(G)$ , where  $X' \in \mathcal{D}'$  is uniquely determined by  $X'_E = \mathcal{L}(v) \in \mathcal{D}$  (see Lemma 5.2.1 above):

**5.2.2 Definition (Localization of Cocircuit Graph)** Let  $\mathcal{M} = (E, \mathcal{F})$  be an oriented matroid with cocircuit graph  $G$  and associating bijection  $\mathcal{L} : V(G) \rightarrow \mathcal{D}$ . Let  $\mathcal{M}' = (E \cup f, \mathcal{F}')$  be a single element extension of  $\mathcal{M}$ . This defines a signature  $\sigma : V(G) \rightarrow \{-, +, 0\}$  by  $\sigma(v) := X'_f$  for  $v \in V(G)$ , where  $X' \in \mathcal{D}'$  such that  $X'_E = \mathcal{L}(v)$ . We call  $\sigma$  *the localization of  $G$  w.r.t.  $\mathcal{L}$  and the single element extension  $\mathcal{M} \rightarrow \mathcal{M}'$ .*

The set of cocircuits of the single element extension is determined by a localization as follows:

**5.2.3 Lemma ([LV78b])** *Let  $G$  be the cocircuit graph of an oriented matroid  $\mathcal{M}$  associated to the set of cocircuits  $\mathcal{D}$  by  $\mathcal{L} : V(G) \rightarrow \mathcal{D}$ . A localization  $\sigma$  of  $G$  w.r.t.  $\mathcal{L}$  and a single element extension  $\mathcal{M} \rightarrow \mathcal{M}'$  determines the extended cocircuit set  $\mathcal{D}'$  as the set of all sign vectors  $X' \in \{-, +, 0\}^{E \cup f}$  for which*

- $X' \setminus f = \mathcal{L}(v)$  and  $X'_f = \sigma(v)$  for some vertex  $v \in V(G)$ , or
- $X' \setminus f = \mathcal{L}(v) \circ \mathcal{L}(w)$  and  $X'_f = 0$  for some edge  $\{v, w\} \in E(G)$  with  $\{\sigma(v), \sigma(w)\} = \{-, +\}$ ,

where  $f \notin E$  is a new element.

**Proof** By Lemma 5.2.1 and the definition of the localization  $\sigma$ , for every  $v \in V(G)$  there is a unique  $X' \in \mathcal{D}'$  such that  $X' \setminus f = \mathcal{L}(v)$  and  $X'_f = \sigma(v)$ . The claim states that the remaining cocircuits in  $\mathcal{D}'$  are the sign vectors  $X'$  on  $E \cup f$  of the form  $X' \setminus f = \mathcal{L}(v) \circ \mathcal{L}(w)$  and  $X'_f = 0$  for some edge  $\{v, w\} \in E(G)$  with  $\{\sigma(v), \sigma(w)\} = \{-, +\}$ . Consider any  $X' \in \mathcal{D}'$  and set  $X = X' \setminus f \in \mathcal{F}$ . By assumption,  $f$  is not a coloop of  $\mathcal{M}'$ . Hence Corollary 0.4.9 (iii) implies that  $\text{rank}_{\mathcal{M}}(X) = \text{rank}_{\mathcal{M}'}(X')$  or  $\text{rank}_{\mathcal{M}}(X) = \text{rank}_{\mathcal{M}'}(X') + 1$ . In the first case  $X \in \mathcal{D}$ , which was discussed above. In the latter case  $\text{span}_{\mathcal{M}'}(X^0) \neq X'^0$  (see Corollary 0.4.9 (iii)), so  $X^0$  is a coline in  $\underline{\mathcal{M}}$  and  $\underline{\mathcal{M}'}$ , and  $X'_f = 0$ . Furthermore,  $\text{rank}_{\mathcal{M}}(X) = 2$  implies that there is an edge  $\{v, w\} \in E(G)$  such that  $X = \mathcal{L}(v) \circ \mathcal{L}(w)$ . Let  $V', W' \in \mathcal{D}'$  be determined by  $V' \setminus f = \mathcal{L}(v)$  and  $W' \setminus f = \mathcal{L}(w)$ , then  $V'_f = \sigma(v)$  and  $W'_f = \sigma(w)$ . Then  $X = \mathcal{L}(v) \circ \mathcal{L}(w)$  implies  $\underline{V' \setminus f} \subseteq \underline{X' \setminus f}$  and  $\underline{W' \setminus f} \subseteq \underline{X' \setminus f}$ , so (C2) is satisfied only if  $V'_f \neq 0$  and  $W'_f \neq 0$ . If  $V'_f = -W'_f$  then  $\{\sigma(v), \sigma(w)\} = \{-, +\}$ , what we claimed. We show that  $V'_f = W'_f$  leads to a contradiction. Assume  $V'_f = W'_f \neq 0$ . Apply cocircuit elimination (C3) to  $V', -W' \in \mathcal{D}'$ , and  $f$ : there exists  $Z' \in \mathcal{D}'$  such that  $Z'_f = 0$  and  $Z'_g \in \{V'_g, -W'_g, 0\}$  for all  $g \in E \cup f$ . Hence  $\underline{Z'} \subseteq \underline{X'}$ , and by (C2)  $Z' = X'$  or  $Z' = -X'$ . But  $V' \neq W'$  and  $V' \neq -W'$  implies that there is  $g \in \underline{W' \setminus V'}$ , for which  $Z'_g \neq X'_g$ , and there is  $g \in \underline{V' \setminus W'}$ , for which  $Z'_g \neq -X'_g$ . This proves that  $V'_f = W'_f \neq 0$  is not possible. ■

The rank of the extended oriented matroid  $\mathcal{M}'$  is the same as the rank of  $\mathcal{M}$  (extensions of coloops are excluded by assumption). If  $\sigma(v) = 0$  for all  $v \in V(G)$  then  $f$  is a loop of  $\mathcal{M}'$ . If  $\mathcal{M}$  is a simple oriented matroid, then  $\mathcal{M}'$  is also simple unless

- $\sigma(v) = 0$  for all  $v \in V(G)$  or
- there exists  $e \in E$  such that  $\sigma(v) = \mathcal{L}(v)_e$  for all  $v \in V(G)$  or
- there exists  $e \in E$  such that  $\sigma(v) = -\mathcal{L}(v)_e$  for all  $v \in V(G)$ .

The cocircuit graph of the single element extension  $\mathcal{M}'$  is determined by  $\mathcal{D}'$ , as any set of cocircuits determines the corresponding cocircuit graph. We cannot determine the cocircuit graph  $G'$  of the single element extension from  $G$  and a localization  $\sigma$ , as we do not know between which vertices of  $G'$  the edges corresponding to the new colines have to

be placed. So we will first compute the single element extension (i.e., the set of cocircuits  $\mathcal{D}'$ ) and then the cocircuit graph  $G'$ . We briefly describe an algorithm which computes the cocircuit graph  $G'$  for a given set of cocircuits  $\mathcal{D}' \subseteq \{-, +, 0\}^E$  in  $O((f'_0)^3 n')$  elementary arithmetic steps as follows, where  $f'_0 = |\mathcal{D}'|$  and  $n' = |E'|$  (the same algorithm has already been described in the proof of Theorem 2.5.1): The vertex set of  $G'$  is a set  $V(G')$  associated by a bijection  $\mathcal{L}'$  to  $\mathcal{D}'$ . For every vertex  $v \in V(G')$  consider the set

$$S(v) := \{(\mathcal{L}'(v) \circ \mathcal{L}'(w))^0 \subseteq E' \mid w \in V(G') \setminus v \text{ such that } D(\mathcal{L}'(v), \mathcal{L}'(w)) = \emptyset\},$$

then  $\{v, w\} \subseteq V(G')$  is an edge of  $G'$  if and only if  $(\mathcal{L}'(v) \circ \mathcal{L}'(w))^0$  is maximal in  $S(v)$ .

The vertex set  $V(G)$  of a cocircuit graph  $G$  is partitioned by a signature  $\sigma$  into  $V^-, V^+, V^0$ , where  $V^s := \{v \in V(G) \mid \sigma(v) = s\}$  for  $s \in \{-, +, 0\}$ ; let  $G^-$  and  $G^+$  denote the subgraphs of  $G$  induced by  $V^-$  and  $V^+$ , respectively (we have introduced this notation already for tope graphs in Section 4.2).

For the following discussion the notion of coline cycles becomes important again (coline cycles have been introduced in Section 2.2, see Definition 2.2.4; we have used coline cycles already in the previous section).

The following characterization of localizations of cocircuit graphs will be highly important for the design of efficient methods for the generation of oriented matroids.

**5.2.4 Theorem (Las Vergnas [LV78b])** *Let  $G$  be the cocircuit graph of an oriented matroid  $\mathcal{M}$  with  $\text{rank}(\mathcal{M}) \geq 2$ , given with the set of all coline cycles of  $G$ , and let  $\sigma : V(G) \rightarrow \{-, +, 0\}$  be a signature of  $G$ . Then  $\sigma$  is a localization of  $G$  w.r.t.  $\mathcal{L}$  and some single element extension  $\mathcal{M} \rightarrow \mathcal{M}'$  if and only if for every coline cycle  $c$  in  $G$  one of the following is valid:*

- (I)  $\sigma(v) = 0$  for every vertex  $v$  in  $c$ .
- (II) There are two vertices  $v$  and  $v'$  in  $c$  with  $\sigma(v) = \sigma(v') = 0$  such that  $v$  and  $v'$  divide  $c$  into two paths  $c^-$  and  $c^+$  of the same length which connect  $v$  and  $v'$ , and, for every vertex  $w$  in  $c$  different from  $v$  and  $v'$ ,  $\sigma(w) = -$  if  $w$  is in  $c^-$  and  $\sigma(w) = +$  if  $w$  is in  $c^+$ .
- (III) Same as (II) except that  $\sigma(v) = -$  and  $\sigma(v') = +$ .

We will refer to I, II, III as the three possible *types* of a coline cycle (see Figure 5.1 for an illustration).

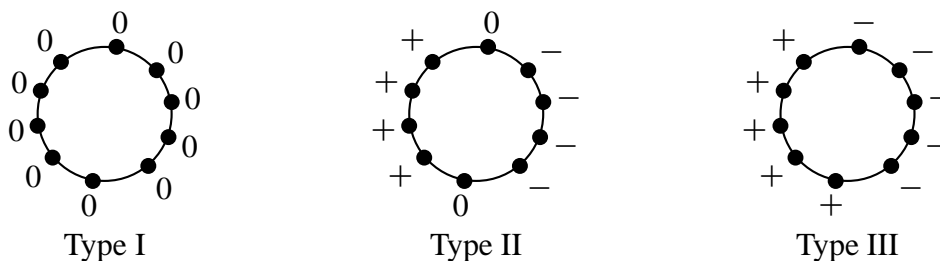

Figure 5.1: The three possible types of a coline cycle

The following proof follows [LV78b]; our proof also explicitly shows that the zero supports of the extended sign vectors form a set of hyperplanes of a matroid, which is a result Crapo [Cra65].

**Proof of Theorem 5.2.4** From the discussion of oriented matroids of rank 2 (see Corollary 1.4.4 and Lemma 2.2.1) it is clear that on every coline cycle the induced signature has to satisfy one of I, II, and III. We show in the following that this is sufficient, i.e., that then the extended set of sign vectors  $\mathcal{D}'$  satisfies the (modular) cocircuit axioms (see Proposition 0.6.9).

Assume that  $\sigma$  is a signature which satisfies I, II, or III for every coline cycle. We define a set  $\mathcal{D}'$  by  $\sigma$  and  $\mathcal{L}$  as in Lemma 5.2.3, where  $f \notin E$  is the new element. Let  $L$  be the M-label induced by  $\mathcal{L}$ , i.e.,  $L(v) := \mathcal{L}(v)^0$  for all vertices  $v \in V(G)$ . We first prove that the set of zero supports of  $\mathcal{D}'$  is a set of hyperplanes  $\mathcal{H}'$  of a matroid  $M'$ . By definition of  $\mathcal{D}'$  and because of the assumptions on the type of every coline cycle,  $\mathcal{H}'$  is determined as the set of sets  $H' \subseteq E \cup f$  for which

- $H' = L(v) \cup f$  for  $v \in V^0$ ,
- $H' = L(v)$  for  $v \in V(G) \setminus V^0$ , or
- $H' = (L(v) \cap L(w)) \cup f$  for an edge  $\{v, w\} \in E(G)$  with  $\{\sigma(v), \sigma(w)\} = \{-, +\}$ ,

For (H1) consider  $X', Y' \in \mathcal{H}'$  with  $X' \subseteq Y'$ . Set  $X := X' \setminus f$  and  $Y := Y' \setminus f$ . Obviously  $X \subseteq Y$ . If  $X \subsetneq Y$  then  $X = L(v) \cap L(w) \subsetneq L(u) = Y$  for some vertices  $v, w, u \in V(G)$  where  $X$  is a coline in  $\underline{\mathcal{M}}$ . Hence  $f \in X' \subseteq Y'$ . By assumption  $\{\sigma(v), \sigma(w)\} = \{-, +\}$ , i.e., the coline cycle of  $X$  has type III, but since the vertex  $u$  is on the coline cycle of  $X$ ,  $f \notin Y'$ , a contradiction. If  $X = Y$  then either  $X = Y$  is a coline and hence  $f \in X' = Y'$ , or  $X = Y = L(v)$  for some vertex  $v \in V(G)$ , hence by symmetry (C2) of  $\mathcal{L}$  and the symmetry of  $\sigma$ ,  $X' = Y'$ . For (H2) consider  $X', Y' \in \mathcal{H}'$  with  $X' \neq Y'$  and  $e \in (E \cup f) \setminus (X' \cup Y')$ . We have to show that there exists  $Z \in \mathcal{H}'$  such that  $R' := (X' \cap Y') \cup e \subseteq Z'$ . Set  $X := X' \setminus f$ ,  $Y := Y' \setminus f$ , and  $R := R' \setminus f$ . If  $e \neq f$  then  $R = (X \cap Y) \cup e$ , otherwise  $R = X \cap Y$ . If  $\text{span}_{\underline{\mathcal{M}}}(R)$  is not a hyperplane in  $\underline{\mathcal{M}}$  then consider any coline  $U \in \underline{\mathcal{M}}$  such that  $R \subseteq U$ . By assumption on the type of the coline cycle of  $U$  and by the definition of  $\mathcal{D}'$  there exists  $Z' \in \mathcal{H}'$  such that  $U \subseteq Z'$  and  $f \in Z'$ , hence  $R' \subseteq Z'$ . If  $\text{span}_{\underline{\mathcal{M}}}(R)$  is a hyperplane in  $\underline{\mathcal{M}}$  then  $\text{span}_{\underline{\mathcal{M}}}(X \cap Y) = X \cap Y$  is a coline in  $\underline{\mathcal{M}}$  (note that  $X' \neq Y'$  and (H1) imply  $X \neq Y$ ), and  $e \neq f$ . By definition there exists  $Z' \in \mathcal{H}'$  such that  $\text{span}_{\underline{\mathcal{M}}}(R) \subseteq Z'$ , so  $R \subseteq Z'$ . If  $f \in X' \cap Y'$  then by assumption the coline cycle of  $X \cap Y$  has type I, hence also  $f \in Z'$ .

It is not difficult to see that (C0) to (C2) are valid by definition and by the symmetry of  $\sigma$  w.r.t. to antipodes in  $G$ . It remains to check modular cocircuit elimination (C3<sup>m</sup>). Let  $X', Y' \in \mathcal{D}'$  be modular in the matroid  $M'$ , i.e.,  $U' := X'^0 \cap Y'^0$  is a coline in  $M'$ . Let  $e \in D(X', Y')$ . We have to show that there exists  $Z' \in \mathcal{D}'$  such that  $Z'_e = 0$  and  $Z'_g \in \{X'_g, Y'_g, 0\}$  for all  $g \in E \cup f$ . Let  $X, Y \in \mathcal{F}$  be defined by  $X := X' \setminus f$  and  $Y := Y' \setminus f$ , and set  $U := U' \setminus f$ .

- Assume  $\text{span}_{M'}(U) = U'$ . This implies  $\text{rank}_{\underline{\mathcal{M}}}(U) = \text{rank}_{M'}(U')$  (see Corollary 0.4.8 (iii)), hence  $U$  is a coline in  $\underline{\mathcal{M}}$ . Note that  $U' \cup e$  spans a hyperplane

in  $M'$ , hence there is a sign vector  $Z' \in \mathcal{D}'$  such that  $U' \cup e \subseteq Z'^0$ , and by (C2) this  $Z'$  is determined up to negative. Set  $Z := Z' \setminus f$ , then  $U \subseteq Z^0$ . Consider the coline cycle  $c(U)$  of  $U$  in the cocircuit graph  $G$  of  $\mathcal{M}$ . Denote by  $x, y, z, \bar{z}$  the vertices or edges in  $c(U)$  that correspond to  $X, Y, Z, -Z$ . The contraction of  $\mathcal{M}$  to  $U$  is an oriented matroid of rank 2 whose cocircuit graph corresponds to the subgraph of  $c(U)$  in  $G$ . From the characterizations of rank 2 oriented matroids (Corollary 1.4.4) it follows that  $z$  or  $\bar{z}$  is on the shorter path from  $x$  to  $y$  (note that  $X \neq -Y$  because of the modularity of  $X'$  and  $Y'$ ), and in the latter case we replace  $-Z$  by  $Z$ . Since  $\sigma$  observes one of the three possible types on  $c(U)$ , in any case  $Z'_e = 0$  and  $Z'_g \in \{X'_g, Y'_g, 0\}$  for all  $g \in E \cup f$ .

- Assume  $\text{span}_{M'}(U) \neq U'$ . Then  $f \in U'$ , i.e.,  $X'_f = Y'_f = 0$  and  $f \neq e$ , and by (C2) for  $X', Y' \in \mathcal{D}'$  follows that there exist  $g \in \underline{Y} \setminus \underline{X} = X^0 \setminus Y^0$ . By the strong hyperplane exchange axiom applied for  $X'^0, Y'^0, e$ , and  $g$ , there exists a hyperplane in  $M'$  which contains  $U'$  and  $e$  but not  $g$ ; because of the modularity of  $X'$  and  $Y'$  this hyperplane is the span of  $U' \cup e$  in  $M'$ . Hence there exists  $Z' \in \mathcal{D}'$  such that  $U' \cup e \subseteq Z'^0$  and  $Z'_g \neq 0$ . Because of (C2),  $Z'$  is determined up to negative, and we choose  $Z'$  such that  $Z'_g = Y'_g$ . Similar as for  $g$ , there exists  $h \in \underline{X} \setminus \underline{Y} = Y^0 \setminus X^0$  such that  $Z'_h \neq 0$ . If  $Z'_i \in \{X'_i, Y'_i, 0\}$  for all  $i \in E$ , we are done (note that  $X'_f = Y'_f = Z'_f = 0$ ). Otherwise let  $i \in E$  be such that  $Z'_i \notin \{X'_i, Y'_i, 0\}$ . As  $\text{span}_{M'}(U) \neq U'$  implies  $\text{rank}_{M'}(U) = \text{rank}_{M'}(U') - 1$ , the contraction minor  $M'/U$  is a matroid of rank 3. Furthermore, by the choice of  $e, g, h$ , and  $i$ , also its deletion minor  $\tilde{M} := (M'/U) \setminus (E \setminus \{e, f, g, h, i\})$  is of rank 3. The orientation  $\mathcal{D}'$  induces an orientation of  $\tilde{M}$ . The analysis of all possible orientations of matroids of rank 3 on ground sets of 5 elements shows that no case supports all assumptions. ■

It is not difficult to see that a single element extension of a uniform oriented matroid is again uniform if and only if the corresponding localization of the cocircuit graph satisfies  $V^0 = \emptyset$ , i.e., every coline cycle has type III.

We conclude this section with the following lemma which will be important for some of the algorithms in the next section:

**5.2.5 Lemma** *Let  $G$  be the cocircuit graph of some oriented matroid and let  $\sigma : V(G) \rightarrow \{-, +, 0\}$  be a localization of  $G$  w.r.t. a given associating bijection  $\mathcal{L}$  and some single element extension. Then  $G^+$  (and also  $G^-$ ) is a connected subgraph of  $G$ .*

For the proof of the lemma we need Proposition 2.2.5 which states that for any element  $e$  the subgraph induced by the vertices  $v$  for which  $\mathcal{L}(v)_e = +$  is connected.

**Proof of Lemma 5.2.5** Let  $G$  be the cocircuit graph of an oriented matroid  $\mathcal{M} = (E, \mathcal{F})$  with associating bijection  $\mathcal{L} : V(G) \rightarrow \mathcal{D}$ . Let  $\sigma : V(G) \rightarrow \{-, +, 0\}$  be a localization of  $G$  w.r.t.  $\mathcal{L}$  and some single element extension. The localization  $\sigma$  and  $\mathcal{L}$  define a single element extension  $\mathcal{M}' = (E \cup f, \mathcal{F}')$  with new element  $f$  as stated in Lemma 5.2.3. Consider the cocircuit graph  $G'$  of  $\mathcal{M}'$  with associating bijection  $\mathcal{L}' : V(G') \rightarrow \mathcal{D}'$ . Let  $V_f^+$  denote the set of vertices with  $\mathcal{L}'(v)_f = +$ . For any two vertices  $v, w \in V_f^+ =$



$\{v \in V(G) \mid \sigma(v) = +\}$  there are uniquely determined vertices  $v', w' \in V(G')$  such that  $\mathcal{L}'(v') \setminus f = \mathcal{L}(v)$  and  $\mathcal{L}'(w') \setminus f = \mathcal{L}(w)$ , and then  $\mathcal{L}'(v')_f = \mathcal{L}'(w')_f = +$ , i.e.,  $v', w' \in V_f^+$ . By Proposition 2.2.5, the subgraph of  $G'$  induced by  $V_f^+$  is connected. Hence there exists a path  $v' = u'_0, \dots, u'_k = w'$  in  $G'$  connecting  $v'$  and  $w'$  with  $u'_i \in V_f^+$  for  $i \in \{0, \dots, k\}$ . For every  $u'_i$  there is a unique  $u_i \in V(G)$  such that  $\mathcal{L}(u_i) = \mathcal{L}'(u'_i) \setminus f$ , and then  $\sigma(u_i) = +$ ; furthermore  $\{u'_{i-1}, u'_i\} \in E(G')$  implies  $\{u_{i-1}, u_i\} \in E(G)$  for  $i \in \{1, \dots, k\}$ :  $v, w$  are connected within  $V^+$ , hence  $G^+$  is connected. The connectedness of  $G^-$  follows by symmetry. ■

**5.2.6 Definition (Weak Localization)** Let  $G$  be the cocircuit graph of an oriented matroid  $\mathcal{M}$  with associating bijection  $\mathcal{L} : V(G) \rightarrow \mathcal{D}$ . For every vertex  $v \in V(G)$  we call the vertex  $\bar{v}$  determined by  $\mathcal{L}(\bar{v}) = -\mathcal{L}(v)$  the *antipode of  $v$* . We call a signature  $\sigma$  of  $G$  a *weak localization of  $G$*  if  $\sigma(\bar{v}) = -\sigma(v)$  for every vertex  $v \in V(G)$  and  $G^+$  (and by symmetry also  $G^-$ ) is connected.

It is clear from Theorem 5.2.4 and Lemma 5.2.5 that every localization of a cocircuit graph is also a weak localization, but not every weak localization is a localization (this fails already for rank 2 and a ground set of 3 elements).

## 5.3 Two Methods for the Generation of Localizations

This section introduces two methods for the generation of localizations of cocircuit graphs. The methods, which are similar to those presented for tope graphs in Sections 4.3 and 4.4, can be used as part of an incremental method as described in Section 3.3.

Note that for the generation of localizations of a cocircuit graph we need more than the cocircuit graph, namely also an associating bijection. This has not been the case in the methods using tope graphs.

The main idea of the following two methods is to generate first all weak localizations and then to test these signatures for being localizations (e.g., using the characterization of Theorem 5.2.4). As for the generation of weak acycloidal signatures in tope graphs the property that the subgraphs  $G^+$  and  $G^-$  are connected graphs is essential. This leads to algorithms `WEAKLOCALIZATIONSREVERSESEARCH` and `WEAKLOCALIZATIONSUPTOISOMORPHISM` which are similar to the algorithms `WEAKACYCLOIDALSIGNATURESREVERSESEARCH` and `WEAKACYCLOIDALSIGNATURESUPTOISOMORPHISM` which are discussed in Sections 4.3 and 4.4. Due to the similarity, we omit a detailed description.

We consider some improvements of the two methods, similar to those presented in Section 4.5. Let  $\mathcal{M}$  be an oriented matroid with cocircuit graph  $G$  and associating bijection  $\mathcal{L}$ , and  $\sigma$  a localization of  $G$  w.r.t.  $\mathcal{L}$  and a single element extension  $\mathcal{M} \rightarrow \mathcal{M}'$ .

We call  $\sigma$  a *maximal localization of  $G$  w.r.t.  $\mathcal{L}$*  if the difference  $|\mathcal{D}'| - |\mathcal{D}|$  of the number of cocircuits in  $\mathcal{M}'$  and  $\mathcal{M}$  is maximal among the differences between  $|\mathcal{D}'|$  and the number of cocircuits of any deletion minor  $\mathcal{M}' \setminus e$ . Maximal localizations are characterized by

$G$  and  $\mathcal{L}$  (of course, since  $\mathcal{L}$  gives full information about  $\mathcal{M}$ ), but we cannot use non-maximality of localizations as a stopping criterion (as in the case of tope graphs). In fact, practically we only use maximal localizations after the generation of weak localizations and after omitting signatures which are not localizations in order to reduce the amount of isomorphism checking.

Another improving step may be to test for every signature in the algorithms `WEAKLOCALIZATIONSREVERSESEARCH` and `WEAKLOCALIZATIONSUPTOISOMORPHISM` whether the signature violates the coline types in a way such that also all augmentations will be violating (as introduced for tope graphs, an augmentation of a signature  $\sigma$  is a signature  $\tau$  such that  $\tau(v) = \sigma(v)$  for all  $\sigma(v) \neq 0$ ). For an example see Figure 5.2; any augmentation does not change the nonzero signs which already violate all of the three coline types I, II, and III.

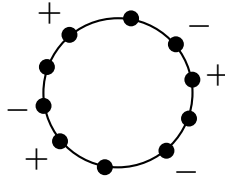

Figure 5.2: Infeasible assignment of a coline cycle

The computational experience shows that the methods introduced in this section as well as the analogous methods for tope graphs work for smaller instances satisfactory and lead to the same results, but the larger the instances the larger is the difference between the number of weak localizations and localizations, which then makes the methods rather inefficient. Cocircuit graphs are smaller than tope graphs (cf. Corollary 1.5.2), which makes the cocircuit graph algorithms running somewhat faster. The fact that the algorithms do not use a good characterization of localizations may explain why they are rather slow, at least compared to the method presented in the following section.

## 5.4 Backtracking Method for the Generation of Localizations

The characterization of localizations of cocircuit graphs as formulated in Theorem 5.2.4 offers a more structured approach to localizations than it was possible for tope graphs or used in the methods of the previous section. We may try to assign to every coline cycle in a given cocircuit graph a sign pattern of type I, II, or III in a consistent way. We will do this using a simple backtracking method, which leads to a third algorithm `LOCALIZATIONS PATTERNBACKTRACK` as discussed in the following which is much more efficient in practice than the methods presented so far.

Let  $\mathcal{D}$  be a set of cocircuits of an oriented matroid  $\mathcal{M} = (E, \mathcal{F})$ . As described in Section 5.2, we can compute in  $O(f_0^3 n)$  elementary arithmetic steps its cocircuit graph  $G$  and an associating bijection  $\mathcal{L} : V(G) \rightarrow \mathcal{D}$ , where  $n := |E|$  and  $f_0 = |\mathcal{D}| = V(G)$ .

Then compute the set  $\{c_1, \dots, c_s\}$  of all coline cycles of  $G$ , where every cycle  $c_i$  is represented as a list of vertices  $\{v_1^i, \dots, v_{m_i}^i\}$  which is ordered such that  $\{v_{j-1}^i, v_j^i\}$  is an edge for all  $j \in \{2, \dots, m_i\}$ , where  $m_i$  is the length of coline cycle  $c_i$ . With  $f_1 = |E(G)|$ , this computation costs at most  $O(f_0 f_1 n)$ , i.e., not more than  $O(f_0^3 n)$  (note that  $\sum m_i = f_1$  and  $s \leq f_1 \leq f_0^2$ ). For a signature  $\sigma$  of  $G$  let  $\sigma_i$  denote the restriction of  $\sigma$  to the vertex set of cycle  $c_i$ . Theorem 5.2.4 implies that  $\sigma_i$  has one of three types, more precisely one of  $2m_i + 1$  patterns, which we encode in a number  $p_i \in \{0, \dots, 2m_i\}$  as follows (set  $v_{m_i+1}^i := v_1^i$ ):

$p_i = 0$	$\sigma_i$ is of type I
$p_i = 2j$ for $j \in \{1, \dots, m_i\}$	$\sigma_i$ is of type II and $\sigma(v_j^i) = 0, \sigma(v_{j+1}^i) = +$
$p_i = 2j - 1$ for $j \in \{1, \dots, m_i\}$	$\sigma_i$ is of type III and $\sigma(v_j^i) = -, \sigma(v_{j+1}^i) = +$

Our algorithm will set all  $p_i$  (and by this  $\sigma_i$ ) for  $i \in \{1, \dots, s\}$  in a consistent way, i.e., such that for every vertex  $v \in V(G)$  the sign of  $\sigma_i(v)$  is the same for all coline cycles  $c_i$  which contain  $v$ . Assume that for a set of indices  $I \subseteq \{1, \dots, s\}$  we have chosen  $p_i$  for all  $i \in I$  (in a consistent way), and it remains to choose  $p_i$  for  $i \notin I$ . Obviously, the patterns  $p_i$  for  $i \in I$  restrict the possibilities for the remaining choices. Consider  $i \notin I$ : For some of the vertices in the coline cycle  $c_i$  the signs may be determined by previously fixed patterns of coline cycles which intersect  $c_i$ , and therefore only some (or possibly none) of the  $2m_i + 1$  patterns remain. We call these directly computable restrictions *the first-order consequences implied by  $p_i$  for  $i \in I$* . These first-order consequences will usually determine the signs of vertices on cycles  $c_i$  with  $i \notin I$  which were not set before, and these new signs imply further restrictions for the  $p_i$  for  $i \notin I$ , and so on: The computation of implied restrictions can be continued recursively and will finally lead to what we call *the second-order consequences implied by  $p_i$  for  $i \in I$*  (second-order consequences have been introduced by Bokowski, see [BGdO00]). Although the second-order consequences reduce the amount of enumeration, we simplify the following discussion of our algorithm by restricting to first-order consequences; our method will be such that the improvement by second-order consequences is not of importance in practice.

We describe in the following an algorithm LOCALIZATIONS PATTERN BACKTRACK which serves as a concrete variant of our method. This algorithm is quite simple and rather efficient, but still it may be improved (e.g., using second-order consequences or more sophisticated data structures). Let us assume that all coline cycles  $c_i$  of the given cocircuit graph  $G$  have been computed as described above. The goal is to enumerate all localizations of  $G$  by enumerating all consistent choices  $(p_1, \dots, p_s)$  with  $p_i \in \{0, \dots, 2m_i\}$ . Consider  $I \subseteq \{1, \dots, s\}$  as a set of indices for which the corresponding  $p_i$  have been fixed (in the beginning  $I = \emptyset$ ). The first-order consequences implied by  $p_i$  for  $i \in I$  restrict the possible choices of every  $p_i$  with  $i \notin I$  to one of the following cases:

(P1) All  $2m_i + 1$  possibilities.

(P2) A range  $[p, p'] \subseteq \{1, \dots, 2m_i\}$  of possibilities for  $p, p' \in \{1, \dots, 2m_i\}$  with  $p, p'$  odd, where  $[p, p'] := \{p, \dots, p'\}$  if  $p \leq p'$  and  $[p, p'] := \{p', \dots, 2m_i, 1, \dots, p\}$  otherwise.

(P3) The choice is one of  $0, 2j, 2j + m_i$  for  $j \in \{1, \dots, m_i/2\}$ .

(P4) The only choice is  $2j$  for  $j \in \{1, \dots, m_i\}$ .

(P5) The only choice is  $p_i = 0$ .

(P6) There is no feasible choice.

An important element in the following algorithm is the augmentation of the set  $I$  of fixed patterns by an additional element  $i^*$ ; then the information of the possible choices has to be updated. For this a matrix  $A$  of size  $s \times s$  is computed (once at the beginning of the algorithm, which will cost at most  $O(ns^2)$  operations) such that

$$A_{ii^*} = \begin{cases} 0 & \text{if } c_i \text{ and } c_{i^*} \text{ have no vertex in common or } i = i^*, \\ j > 0 \text{ such that } v_j^i \text{ is on } c_{i^*} & \text{otherwise.} \end{cases}$$

We call  $A$  a *coline adjacency matrix*. It is not difficult to see that then an update of the first-order consequences from  $I$  to  $I \cup \{i^*\}$  needs for every  $i \in \{1, \dots, s\}$  only a constant number of operations. It can be seen that for the enumeration of coline cycle patterns a coline adjacency matrix  $A$  and a list giving all the lengths  $m_i$  of the coline cycles are sufficient (we do not need an explicit description of the cocircuit graph or the coline cycles).

It remains to discuss the order in which we fix the patterns  $p_i$ , and this is of great importance w.r.t. the efficiency of the algorithm. If  $I = \emptyset$  we choose any  $i \in \{1, \dots, s\}$  with maximal  $m_i$  (i.e., a longest cycle). If  $\emptyset \neq I \subsetneq \{1, \dots, s\}$ , let  $I^*$  denote the set of all  $i \notin I$  for which  $c_i$  intersects at least one coline cycle from  $I$  ( $I^*$  is not empty, see Lemma 2.2.6); then we choose  $i^* \in I^*$  such that  $p_{i^*}$  has a minimal number of possible choices w.r.t. the first-order consequences implied by  $I$ . We call this a *dynamic ordering*. This finally leads to the algorithm LOCALIZATIONSPATTERNBACKTRACK which is summarized in Pseudo-Code 5.1.

The algorithm LOCALIZATIONSPATTERNBACKTRACK is much more efficient than all the previous algorithms for the generation of oriented matroids described in this thesis, which is also observed from the performance of implementations. Considering only first-order consequences instead of second-order consequences did not cause many infeasible situations in the backtracking method; e.g., for  $|E| \leq 6$  and any rank the number of infeasible cases was always less than 10% of the number of localizations, and for larger instances this also increases only a little. For more computational results see Chapter 6.

Whereas the first four algorithms which have been described in Sections 4.3, 4.4, and 5.3 do not seem to be similar to previously known methods for the generation of oriented matroids, the algorithm LOCALIZATIONSPATTERNBACKTRACK turned out to be related to an algorithm of Bokowski and Guedes de Oliveira [BGdO00]. At first, the two algorithms appear to be rather different. While we use cocircuits and cocircuit graphs, the oriented matroid representation in [BGdO00] is based on the chirotope axioms and concentrates on uniform oriented matroids. This leads to different data structures in the algorithms (see below). Nevertheless, the two algorithms are closely related when interpreted as algorithms in dual settings, namely hyperplane arrangements vs. point configurations: Localizations of cocircuit graphs correspond to hyperline configurations in [BGdO00] as we

*Global Data:*  $s, m_1, \dots, m_s$ , a coline adjacency matrix  $A$  (see above).  
*Input:*  $I \subseteq \{1, \dots, s\}$ ;  $\tilde{p}_1, \dots, \tilde{p}_s$  such that  $\tilde{p}_i = p_i$  for  $i \in I$  and  $\tilde{p}_i$  for  $i \notin I$  contains the information which patterns are possible w.r.t. the first-order consequences implied by  $p_i$  for  $i \in I$ .  
*Output:* is generated whenever a new localization is found.

```

begin LOCALIZATIONS_PATTERNBACKTRACK( $I; \tilde{p}_1, \dots, \tilde{p}_s$ );
  if some  $\tilde{p}_i$  indicates that no choice  $p_i$  is feasible then return
  else if  $I = \{1, \dots, s\}$  then
    output the localization defined by  $\tilde{p}_1, \dots, \tilde{p}_s$ ;
    return
  else if  $I = \emptyset$  then choose  $i^*$  such that  $m_{i^*}$  is maximal
  else
     $I^* := \{i \notin I \mid A_{ii'} > 0 \text{ for some } i' \in I\}$ ;
    choose  $i^* \in I^*$  such that  $\tilde{p}_{i^*}$  has a minimal number of possible choices
  endif;
  for all possible choices of  $p_{i^*}$  do
    LOCALIZATIONS_PATTERNBACKTRACK( $I \cup \{i^*\}; \tilde{p}_1, \dots, \tilde{p}_s$ ),
    where  $\tilde{p}_1, \dots, \tilde{p}_s$  are updated w.r.t. choice  $p_{i^*}$ ;
  endfor;
  return
end LOCALIZATIONS_PATTERNBACKTRACK.

```

Pseudo-Code 5.1: Algorithm LOCALIZATIONS\_PATTERNBACKTRACK

can consider (halves of) coline cycles and hyperlines (or lines) as being equivalent under dualization. Then patterns of coline cycles as introduced for algorithm LOCALIZATIONS\_PATTERNBACKTRACK and gap positions as used in the algorithm in [BGdO00] coincide. Also the basic idea of how the patterns (or gap positions) are fixed is similar.

Comparison of the algorithms shows that both are based on similar algorithmic concepts, however there are also some important differences. In particular, while the algorithm in [BGdO00] stores both the set of colines and that of bases signatures, our algorithm carries the colines only. Furthermore, the colines are represented by their bases in [BGdO00] that are not unique in non-uniform oriented matroids, our algorithm stores the colines directly. For generating non-uniform oriented matroids, these differences can be substantial. Our algorithm LOCALIZATIONS\_PATTERNBACKTRACK is designed for the general case and the implementation is straightforward, independent from rank or uniformity. Furthermore we can, if we want, easily restrict to the uniform case: We simply do not consider patterns of type I or II, i.e., the only change in algorithm LOCALIZATIONS\_PATTERNBACKTRACK is that only odd values of  $p_i$  are allowed for patterns.

Another remarkable difference is the order in which the fixing of the patterns (or gap positions) is done: The algorithm in [BGdO00] uses a fixed order of hyperlines, our algorithm chooses the next coline  $i^* \notin I$  according to the first-order consequences of the choices

in  $I$ , by this reducing the amount of enumeration and the number of infeasibilities. This is possibly the reason why the use of second-order consequences was a crucial improvement from earlier algorithms in [BGdO00]. We agree that second-order consequences are important as they reduce infeasible cases; in the case of rank 3 oriented matroids they even eliminate all infeasibilities (which was already noted in [BGdO00]). However, our experience shows that also without second-order consequences the performance can be good because the dynamic ordering tends to eliminate infeasible cases efficiently.

A fair comparison of the efficiency of the two algorithms is very difficult as the implementations are too different to be compared directly. However, more detailed comparisons of the oriented matroid generation algorithms will be a basis for further investigations and improvements.

A large, light gray, stylized letter 'I' serves as a background for the page. The letter has a classic serif font style with a slightly flared top and bottom. The word 'Applications' is centered within the vertical stroke of the 'I'.

# **Applications**





*How many be there of them?*

HENRY IV (I:2,2)

## Chapter 6

# A Catalog of Oriented Matroids

### 6.1 Introduction

We present in the following the organization of a catalog of oriented matroids or, more precisely, of the isomorphism classes of oriented matroids. For an overview of the problems of generating oriented matroids or isomorphism classes of oriented matroids see Chapter 3.

The two main goals for the construction of a catalog of isomorphism classes of oriented matroids is *a natural ordering principle* and *an easily accessible data format*.

When looking for ordering principles of oriented matroids up to isomorphism, one has to consider representations and invariants of isomorphism classes. It is natural to restrict representatives of isomorphism classes to simple oriented matroids, and we will do so for the following. Invariants of isomorphism classes include the number  $n$  of elements (of a simple representative), the rank  $r$ , the big face lattice, the tope graph, and the cocircuit graph. It is very natural to use as the first ordering principle  $n$  and  $r$ , i.e., isomorphism classes are grouped together according to  $n$  and  $r$ . As introduced in Section 3.3, let  $IC(n, r)$  denote the set of all such isomorphism classes for given  $n$  and  $r$ . We will consider in the following  $IC(n, r)$  as a list of representatives, where every representative is a simple oriented matroid of rank  $r$  on ground set  $E = \{1, \dots, n\}$ .

The ordering principle inside  $IC(n, r)$  is less clear. For practical reasons a linear order of representatives in  $IC(n, r)$  is desirable. Face lattices and graphs seem to lack a natural total ordering principle themselves [RW98]. For example, if the number of cocircuits (or topes) is the first order principle inside  $IC(n, r)$ , this will lead to a partial order only. Adding second order principles etc. will not solve the problem unless there is a guarantee that this implies a total order for all  $n$  and  $r$ . Also, the choice of invariants (and the order in which they apply) seems to be rather arbitrary.

Instead of looking at invariants of one isomorphism class only, the relationship among

the classes may lead to a natural ordering principle. The most natural relationship is the one established by minors and extensions. Every isomorphism class has a certain set of isomorphism classes of minors (or extensions), independent from the representation of the classes. This might bring up the idea to order  $\text{IC}(n, r)$  by looking at the set of minors of every class and their relative ordering. It would allow a very natural ordering of isomorphism classes if the following question has an affirmative answer: *Is an isomorphism class determined by the set of isomorphism classes of its minors?* However, the answer is no, as can be seen easily from the fact that there are 4 isomorphism classes of uniform oriented matroids in  $\text{IC}(6, 3)$  which all have the same (unique) uniform deletion minor in  $\text{IC}(5, 3)$ .

It seems that reasonable ordering principles will depend on the choice of some representation of the isomorphism class or on the choice of invariants which are arbitrary to some extent. We present in the following one possibility of how to order the classes in  $\text{IC}(n, r)$ , and in Section 6.3 we will discuss some properties which motivate our organization of the catalog under the aspect of being natural and practical.

## 6.2 Organization of Catalog

This section explains the organization of the catalog of isomorphism classes of oriented matroids as motivated in the previous section. On the most general level, the isomorphism classes are grouped in lists  $\text{IC}(n, r)$ , where  $\text{IC}(n, r)$  is a complete list of classes where every class is represented by a simple oriented matroid on ground set  $E = \{1, \dots, n\}$  of rank  $r := \text{rank}(\mathcal{M})$ .

Let  $n$  and  $r$  be given. We have to decide

- how the representative of every class in  $\text{IC}(n, r)$  is encoded,
- which oriented matroid from every isomorphism class is taken as its representative, and
- in which order the isomorphism classes are listed inside  $\text{IC}(n, r)$ .

For the *encoding* of an oriented matroid we use the chirotope representation (see Definition 0.9.6). The chirotope is encoded as a list of  $\binom{n}{r}$  signs in some canonical order of the  $r$ -subsets of  $E = \{1, \dots, n\}$ , i.e., the subsets of  $E$  which contain exactly  $r$  elements (we will discuss the order in more detail below). Note that chirotopes are defined as a pair  $\{\chi, -\chi\}$  of maps which are negatives of each other, and as a canonical way to choose  $\chi$  or  $-\chi$  we take the one which has  $+$  as the first nonzero sign. The chirotope representation is more compact than, e.g., a set of cocircuits (i.e., less memory is needed). Furthermore all classes have an encoding of the same size, and there is only one sequence of signs (not a list of sign vectors), which makes it easy to store many isomorphism classes in one file. For the chirotope representation, we have to explain the ordering of the bases. We choose the *reverse lexicographic order* of the bases, where the elements in every  $r$ -subset of  $E$

are sorted from small to large. Note that usually the chirotope representation uses a lexicographic order [BLVS<sup>+</sup>99]. Our choice is motivated by the fact that the bases of deletion and contraction minors w.r.t. the last element  $n$  are naturally grouped in the reverse lexicographic order (we explain this in more detail in Section 6.3, where we motivate our choice further). See Table 6.1 for an example of lexicographic and reversed lexicographic order for  $n = 5$  and  $r = 3$ ; the last element  $n = 5$  is marked in order to make the bases of the corresponding minors visible.

Lexicographic	Reverse Lexicographic
123	123
124	124
12 <b>5</b>	134
134	234
13 <b>5</b>	12 <b>5</b>
14 <b>5</b>	13 <b>5</b>
234	23 <b>5</b>
23 <b>5</b>	14 <b>5</b>
24 <b>5</b>	24 <b>5</b>
34 <b>5</b>	34 <b>5</b>

Table 6.1: Lexicographic and reverse lexicographic order of bases ( $n = 5, r = 3$ )

**6.2.1 Definition (Encoding)** Let  $\mathcal{M}$  be an oriented matroid of rank  $r$  with ground set  $E = \{1, \dots, n\}$ . We denote by  $\chi(\mathcal{M}) \in \{-, +, 0\}^{\binom{n}{r}}$  the *encoding* of  $\mathcal{M}$  by the lexicographically positive map in the chirotope of  $\mathcal{M}$ , where the signs are given according to reverse lexicographically sorted  $r$ -subsets.

As the *representative* of an isomorphism class we choose the oriented matroid for which its chirotope encoding is lexicographically largest among all oriented matroids in the same isomorphism class, where the signs are ordered as  $- < + < 0$ , which is motivated in the next section.

**6.2.2 Definition (Representative)** Let  $\mathcal{M}$  be an oriented matroid which belongs to some isomorphism class in  $\text{IC}(n, r)$ . We denote by  $\text{rep}(\mathcal{M})$  the uniquely determined simple oriented matroid on ground set  $E = \{1, \dots, n\}$  which is in  $\text{IC}(\mathcal{M})$  and for which  $\chi(\text{rep}(\mathcal{M}))$  is lexicographically maximal, where  $- < + < 0$ .

In order to find  $\text{rep}(\mathcal{M})$  for some given simple oriented matroid  $\mathcal{M}$  one has potentially to consider all permutations of  $\{1, \dots, n\}$  and all reorientations of the elements.

For the *order of the classes* in  $\text{IC}(n, r)$  we use an increasing lexicographic ordering of the representatives, where again  $- < + < 0$  as before. Table 6.2 shows the listing of the 17 isomorphism classes in  $\text{IC}(6, 3)$ ; the  $r$ -subsets are indicated on the top, so  $\{1, 2, 3\}$  is the first triple, then  $\{1, 2, 4\}$ , etc.

	1	1	1	2	1	1	2	1	2	3	1	1	2	1	2	3	1	2	3	4	
	2	2	3	3	2	3	3	4	4	4	2	3	3	4	4	4	5	5	5	5	
c	3	4	4	4	5	5	5	5	5	5	6	6	6	6	6	6	6	6	6	6	
1	+	+	+	+	+	+	+	+	+	+	+	+	+	+	-	+	+	-	-	+	+
2	+	+	+	+	+	+	+	+	+	+	+	+	+	+	+	+	+	+	+	-	-
3	+	+	+	+	+	+	+	+	+	+	+	+	+	+	+	+	+	+	+	+	-
4	+	+	+	+	+	+	+	+	+	+	+	+	+	+	+	+	+	+	+	+	+
5	0	+	+	+	+	+	+	+	+	+	+	+	+	+	+	-	+	-	-	-	-
6	0	+	+	+	+	+	+	+	+	+	+	+	+	+	+	+	+	+	+	-	-
7	0	+	+	+	+	+	+	+	+	+	+	+	+	+	+	+	+	+	+	+	+
8	0	+	+	+	+	+	+	+	+	+	+	+	+	+	+	+	+	+	+	+	0
9	0	+	+	+	+	+	+	0	+	+	+	+	+	+	+	+	+	-	-	-	-
10	0	+	+	+	+	+	+	0	+	+	+	+	+	+	+	+	+	+	+	-	-
11	0	+	+	+	+	+	+	0	+	+	+	+	+	+	+	+	+	+	+	+	-
12	0	+	+	+	+	+	+	0	+	+	+	+	+	+	0	+	+	-	-	-	-
13	0	+	+	+	+	+	+	0	+	+	+	+	+	+	0	+	0	-	-	-	-
14	0	+	+	+	+	+	+	0	+	+	+	+	+	+	0	-	+	-	-	-	-
15	0	0	0	0	+	+	+	+	+	+	+	+	+	+	+	+	+	+	+	+	+
16	0	0	0	0	+	+	+	+	+	+	+	+	+	+	+	+	0	+	+	+	+
17	0	0	0	0	0	0	0	0	0	0	+	+	+	+	+	+	+	+	+	+	+

Table 6.2: The 17 isomorphism classes in IC(6, 3)

**6.2.3 Definition (IC(n, r, c))** Let  $\mathcal{M}$  be an oriented matroid such that  $IC(\mathcal{M})$  belongs to  $IC(n, r)$ . Let  $c \geq 1$  be the position of  $rep(\mathcal{M})$  in  $IC(n, r)$  determined by the lexicographically increasing order of the chirotope encoding of the representatives in  $IC(n, r)$ . We then write  $IC(n, r, c)$  for  $IC(\mathcal{M})$ .

### 6.3 Properties of Catalog

We investigate some of the properties of the catalog which motivates the organization that was presented in the previous section.

As we choose the order of the bases to be reverse lexicographic, the deletion minor  $\mathcal{M} \setminus n$  of an oriented matroid  $\mathcal{M}$ , where  $n \in E = \{1, \dots, n\}$  is the element with highest index, can be easily obtained from the chirotope representation  $\chi(\mathcal{M})$ :

**6.3.1 Lemma** *Let  $\mathcal{M} = (E, \mathcal{F})$  be a simple oriented matroid such that  $E = \{1, \dots, n\}$  for some  $n$ . Set  $r := rank(\mathcal{M})$ .*

- (i) *If  $n \in E$  is not a coloop then the first  $\binom{n-1}{r}$  signs of  $\chi(\mathcal{M})$  are not all 0 and are equal to the signs of  $\chi(\mathcal{M} \setminus n)$  (in the same order).*
- (ii) *If  $n \in E$  is a coloop then the first  $\binom{n-1}{r}$  signs of  $\chi(\mathcal{M})$  are all 0, and the last  $\binom{n-1}{r-1}$  signs of  $\chi(\mathcal{M})$  are equal to the signs of  $\chi(\mathcal{M} \setminus n)$  (in the same order).*

**Proof** Consider first some basic facts about the reverse lexicographic ordering of the  $r$ -subsets of  $E$ . The first  $\binom{n-1}{r}$  subsets do not contain  $n$  and their order is the reverse lexicographic order of the  $(r-1)$ -subsets of  $E$ . After these come the  $\binom{n-1}{r-1}$  subsets that contain  $n$ , and the ordering of these sets (with  $n$  deleted) is the reverse lexicographic ordering of the  $(r-1)$ -subsets of  $E \setminus n$ .

If  $n \in E$  is not a coloop then  $\text{rank}_{\mathcal{M}}(E \setminus n) = \text{rank}_{\mathcal{M}}(E) = r$ , hence there exists a basis  $B$  of  $\mathcal{M}$  which does not contain  $n$  and the corresponding sign (which is  $-$  or  $+$  by definition) is one of the first  $\binom{n-1}{r}$  signs in  $\chi(\mathcal{M})$ . Furthermore, every basis of  $E \setminus n$  is also a basis of  $E$ , and by the definition of a basis orientation  $\chi$  of  $\mathcal{M}$  is the restriction to the deletion minor on  $E \setminus n$  a basis orientation of  $\mathcal{M} \setminus n$ . The claim follows by the above considerations concerning the reverse lexicographic ordering.

If  $n \in E$  is a coloop then  $\text{rank}_{\mathcal{M}}(E \setminus n) = \text{rank}_{\mathcal{M}}(E) - 1 = r - 1$ , hence every  $r$ -subset of  $E \setminus n$  is a dependent set, so the first  $\binom{n-1}{r}$  signs in  $\chi(\mathcal{M})$  are all 0. Since  $n$  is a coloop, every basis of  $\mathcal{M}$  is of the form  $B \cup n$ , where  $B$  is a basis of  $\mathcal{M} \setminus n$ . Since every basis of  $\mathcal{M}$  contains  $n$  and  $n$  is always in the same (last) position of the ordered basis used for the definition of  $\chi$ , the restriction of  $\chi(\mathcal{M})$  to the bases in  $E \setminus n$  satisfies the properties of a basis orientation. As discussed above, the ordering of the  $r-1$  subsets not containing  $n$  is the one of the corresponding extended sets at the last  $\binom{n-1}{r-1}$  positions in the reverse lexicographic order of the  $r$ -subsets of  $E$ , which proves the claim. ■

Because we choose the representative oriented matroid of an isomorphism class to be the oriented matroid with the lexicographically maximal chirotope encoding, Lemma 6.3.1 leads to the following result:

**6.3.2 Proposition** *Let  $\mathcal{M} = (E, \mathcal{F})$  be a simple oriented matroid such that  $\mathcal{M} = \text{rep}(\mathcal{M})$ , hence  $E = \{1, \dots, n\}$  for some  $n$ . Set  $r := \text{rank}(\mathcal{M})$ .*

- (i)  $\mathcal{M} \setminus n = \text{rep}(\mathcal{M} \setminus n)$ .
- (ii)  $\mathcal{M}$  has a coloop if and only if  $n$  is a coloop.
- (iii) If  $n$  is not a coloop then  $\chi(\mathcal{M} \setminus n) = \chi(\text{rep}(\mathcal{M} \setminus n))$  is lexicographically maximal among all  $\chi(\text{rep}(\mathcal{M} \setminus i))$  for  $i \in E = \{1, \dots, n\}$ .

**Proof** Consider  $\chi(\mathcal{M})$ , which is by definition of  $\text{rep}(\mathcal{M})$  the lexicographic maximal encoding of  $\mathcal{M}' \in \text{IC}(\mathcal{M})$ . If  $E$  has a coloop, then  $n$  must be a coloop, since by Lemma 6.3.1 then (and only then) the leading  $\binom{n-1}{r}$  signs in  $\chi(\mathcal{M})$  are all 0, which is clearly maximal because of  $- < + < 0$ . If  $\mathcal{M} \setminus n \neq \text{rep}(\mathcal{M} \setminus n)$  then by definition there exists an isomorphism on  $E \setminus n$  such that  $\chi(\mathcal{M} \setminus n)$  becomes lexicographically larger. Because of Lemma 6.3.1 this also makes  $\chi(\mathcal{M})$  larger, a contradiction to  $\mathcal{M} = \text{rep}(\mathcal{M})$ .

If  $n$  is not a coloop then  $E$  does not have a coloop (see above), hence all encodings  $\chi(\mathcal{M} \setminus i)$  for  $i \in E = \{1, \dots, n\}$  have the same number of signs, which is  $\binom{n-1}{r}$ . Assume that  $\chi(\text{rep}(\mathcal{M} \setminus n))$  is lexicographically smaller than  $\chi(\text{rep}(\mathcal{M} \setminus i))$  for some  $i \in E = \{1, \dots, n\}$ . Then there is an isomorphism which exchanges  $i$  and  $n$  that leads to a lexicographically larger encoding of  $\mathcal{M}$  (already in the first  $\binom{n-1}{r}$  signs), a contradiction to  $\text{rep}(\mathcal{M}) = \mathcal{M}$ . ■

We conclude this section by pointing out some further nice properties of the ordering in our catalog:

**6.3.3 Corollary** *Let  $\mathcal{M} = (E, \mathcal{F})$  be a simple oriented matroid such that  $\mathcal{M} = \text{rep}(\mathcal{M})$ , hence  $E = \{1, \dots, n\}$  for some  $n$ . Set  $r := \text{rank}(\mathcal{M})$  and consider  $\text{IC}(n, r)$ .*

- (i) *The first sign of  $\chi(\mathcal{M})$  is nonzero (hence  $+$ ) if and only if  $\mathcal{M}$  is uniform.*
- (ii) *All isomorphism classes of uniform oriented matroids come consecutively at the first positions in  $\text{IC}(n, r)$ , all non-uniform oriented matroids thereafter.*
- (iii) *All isomorphism classes of oriented matroids which have a coloop come consecutively at the last positions in  $\text{IC}(n, r)$ .*

**Proof** By the definition of a chirotope,  $\chi(\mathcal{M})$  contains no 0 sign if and only if every  $r$ -subset of  $E$  is a basis of  $\mathcal{M}$ , which is the case if and only if  $\mathcal{M}$  is uniform. If  $\mathcal{M}$  is not uniform, a relabeling of the elements in  $E$  such that  $\{1, \dots, r\}$  is not a basis assures that the first sign becomes 0. Because of  $- < + < 0$  a maximal encoding of a non-uniform oriented matroid will start with a 0 sign. The ordering of the classes in  $\text{IC}(n, r)$  is lexicographically increasing in the maximal encodings. As the starting sign of uniform cases is  $+$  and 0 otherwise, by  $- < + < 0$  the uniform cases come before the non-uniform ones. Finally, by Proposition 6.3.2 (ii),  $\mathcal{M}$  has a coloop if and only if  $n$  is a coloop, and by Lemma 6.3.1 this is the case if and only if all leading  $\binom{n-1}{r}$  signs are 0. Because of the lexicographical ordering and  $- < + < 0$  the encodings of classes having a coloop are larger than all other and come at the last positions in  $\text{IC}(n, r)$ . ■

Since uniform oriented matroids do not have zeros in the chirotope representation, they are ordered observing the natural relation  $- < +$  only.

## 6.4 Generation of Catalog

We present in this section a method for the generation of oriented matroid isomorphism classes, producing the catalog as described in Section 6.2. The general approach is described in Chapter 3, and for the generation of single element extensions one of the methods from Chapters 4 and 5 is used; practically this will be algorithm LOCALIZATIONS-PATTERNBACKTRACK since it is most efficient and we will not need extensions which introduce coloops.

For  $n = r$  there is only one isomorphism class (cf. Lemma 3.2.3), and the encoding in the chirotope has only  $\binom{r}{r} = 1$  sign, which is  $+$  by definition. For the generation of  $\text{IC}(n, r)$  with  $n > r \geq 1$  the procedure is as follows:

- Initialize  $\text{IC}(n, r) := \emptyset$ .
- For every  $c$  from 1 to  $|\text{IC}(n-1, r)|$  do:

- Let  $\mathcal{M}$  be the representative of  $\text{IC}(n - 1, r, c)$ , given by its encoding  $\chi(\mathcal{M})$ .
  - Compute all single element extensions  $\mathcal{M}'$  of  $\mathcal{M}$ , where the new element  $n$  is not a coloop of  $\mathcal{M}'$  and  $\mathcal{M}'$  is simple.
  - For every single element extension  $\mathcal{M}'$  compute  $\text{rep}(\mathcal{M}')$  by computing the maximal encoding  $\chi(\text{rep}(\mathcal{M}'))$ .
  - Keep only those extensions  $\mathcal{M}'$  of  $\mathcal{M}$  for which the first  $\binom{n-1}{r}$  signs of  $\chi(\text{rep}(\mathcal{M}'))$  are equal to  $\chi(\mathcal{M})$ .
  - Sort all remaining extensions w.r.t. increasing lexicographical order of the encodings  $\chi(\text{rep}(\mathcal{M}'))$ .
  - Remove multiple entries in the sorted list of extensions.
  - Append the sorted list to  $\text{IC}(n, r)$ .
- For every  $c$  from 1 to  $|\text{IC}(n - 1, r - 1)|$  do:
    - Let be  $\mathcal{M}$  the representative of  $\text{IC}(n - 1, r - 1, c)$ , given by its encoding  $\chi(\mathcal{M})$ .
    - Let  $\chi'$  be the vector of  $\binom{n}{r}$  signs whose first  $\binom{n-1}{r}$  signs are all 0 and whose last  $\binom{n-1}{r-1}$  signs are those of  $\chi(\mathcal{M})$  (in the same order).
    - Append  $\chi'$  to  $\text{IC}(n, r)$ .

**6.4.1 Proposition** *Assume that  $\text{IC}(n - 1, r - 1)$  and  $\text{IC}(n - 1, r)$  have been generated correctly before. Then the method described above correctly generates  $\text{IC}(n, r)$ .*

**Proof** Every class in  $\text{IC}(n, r)$  is generated exactly once: Let  $\mathcal{M}$  be the representative of  $\text{IC}(n, r, c)$ .  $\mathcal{M}$  has to be generated from some deletion minor.

- If  $\mathcal{M}$  does not have a coloop, every deletion minor  $\mathcal{M} \setminus i$  belongs to some class in  $\text{IC}(n - 1, r)$ . For  $i \in \{1, \dots, n\}$  consider  $\mathcal{M}^i := \text{rep}(\mathcal{M} \setminus i)$ . The algorithm writes the single element extension  $\mathcal{M} = \text{rep}(\mathcal{M})$  to  $\text{IC}(n, r)$  if and only if the first  $\binom{n-1}{r}$  signs of  $\chi(\mathcal{M})$  are equal to  $\chi(\mathcal{M}^i)$ . Since  $n$  is not a coloop of  $\mathcal{M}$  and by Lemma 6.3.1 (i) this is the case if and only if  $\chi(\mathcal{M} \setminus n) = \chi(\mathcal{M}^i)$ , i.e., if and only if  $\mathcal{M} \setminus n = \mathcal{M}^i$ . Hence,  $\mathcal{M}$  is generated exactly once, namely when the algorithm considers the class of  $\mathcal{M} \setminus n$ .
- If  $\mathcal{M}$  has a coloop then every coloop minor is the same. This can be seen considering the set of cocircuits  $\mathcal{D}$  and some coloop  $e$ : by the definition of a coloop there are two cocircuits  $X, -X \in \mathcal{D}$  with  $\underline{X} = \{e\}$ , and, by cocircuit axiom (C2),  $Y_e = 0$  for all other cocircuits  $Y \in \mathcal{D}$ . The algorithm generates  $\mathcal{M}$  once when considering the isomorphism class of its (unique) coloop minor.

Every class in  $\text{IC}(n, r)$  is represented correctly:

- If  $\mathcal{M}$  does not have a coloop, the representative  $\text{rep}(\mathcal{M})$  is computed explicitly in the algorithm.

- If  $\mathcal{M}$  has a coloop then its representation is computed from the representation of its unique coloop minor by adding leading 0 signs. By Proposition 6.3.2 (ii),  $n$  has to be a coloop, and by Lemma 6.3.1 this is a correct encoding of  $\mathcal{M}$ . This encoding is lexicographically maximal since the representative of the coloop minor is given by its lexicographical maximal encoding.

Every class in  $\text{IC}(n, r)$  is at the correct position: By Corollary 6.3.3, it is correct to generate first classes of oriented matroids which do not have a coloop, then the other classes. Among the classes of oriented matroids without coloop the main order is given by the first  $\binom{n-1}{r}$  signs of the encoding  $\chi(\mathcal{M})$  of every representative  $\mathcal{M}$ , which is  $\chi(\mathcal{M} \setminus n)$  and which is sorted since the algorithm generates the extensions in the order of  $\text{IC}(n-1, r)$ . The lexicographic order of representatives which have the same first  $\binom{n-1}{r}$  signs in the encoding and hence come from the same deletion minor is obtained by sorting them in the algorithm. Among the classes of oriented matroids which have a coloop the order is trivially the same as in  $\text{IC}(n-1, r-1)$ , which was assumed to be lexicographically sorted. ■

Since the extensions of uniform minors have to be uniform again (otherwise they are discarded in the generation method), this first part may use a specialized algorithm which generates uniform single element extensions only. Such a specialization can be easily obtained from algorithm `LOCALIZATIONSPATTERNBACKTRACK` (see Section 5.4) by restricting to coline patterns of type III (cf. Theorem 5.2.4).

The generation method of this section can be viewed as a sort of reverse search method (see also Section 4.3). The only difference is between the adjacency oracle of a reverse search method [AF96] and the corresponding part in our generation method, which is the generation of single element extensions of some isomorphism class in  $\text{IC}(n-1, r)$ . An adjacency oracle is indexed by an explicit integer, which makes it possible to consider one adjacency (i.e., single element extension) after the other. In our generation method all single element extensions are computed at once, and we cannot avoid multiple extensions from the same minor other than comparing the representatives. However, multiple extensions from different deletion minors are avoided as it is the case in a reverse search method.

A major computational drawback of the method is the need to compute the representatives of all single element extensions. Our representation using a reverse lexicographical order of the bases has the difficulty that the computation of the maximal encodings seems to be rather hard, which is simpler when using a lexicographical order of bases as usual (personal communication with Jürgen Bokowski and Jürgen Richter-Gebert) or a representation by so-called  $\lambda$ -matrices [GP83, AAK01]. There seems to be a large potential of improvement of practical generation methods when using a representative of the isomorphism classes which can be computed faster. However, our choice of representation is still good enough not only to compute all cases which were known previously (i.e., uniform oriented matroids) but also to generate all non-uniform classes for the same  $n$  and  $r$  as considered for the uniform cases; this is presented in the following section.



## 6.5 Overview of Results

This section gives an overview of the results obtained by the generation methods that have been presented in this thesis. This summary displays the number of isomorphism classes of oriented matroids and indicates run time and memory usage.

Table 6.3 shows the numbers  $|\text{IC}(n, r)|$  of isomorphism classes of oriented matroids for  $r \leq n \leq 10$ . Missing numbers for  $r = 1$  and  $n < r$  stand for empty lists  $\text{IC}(n, r)$ , whereas the other missing numbers are unknown. The isomorphism classes not only have been counted but entirely listed (see also Section 6.6).

$n =$	1	2	3	4	5	6	7	8	9	10
$r = 1$	1									
$r = 2$		1	1	1	1	1	1	1	1	1
$r = 3$			1	2	4	17	143	4 890	461 053	95 052 532
$r = 4$				1	3	12	206	181 472		
$r = 5$					1	4	25	6 029		
$r = 6$						1	5	50	508 321	
$r = 7$							1	6	91	
$r = 8$								1	7	164
$r = 9$									1	8
$r = 10$										1

Table 6.3: Number of isomorphism classes of oriented matroids

For comparison, Table 6.4 shows the numbers of isomorphism classes of *uniform* oriented matroids for  $r \leq n \leq 10$ . These numbers have been computed before (see Table 6

$n =$	1	2	3	4	5	6	7	8	9	10
$r = 1$	1									
$r = 2$		1	1	1	1	1	1	1	1	1
$r = 3$			1	1	1	4	11	135	4 382	312 356
$r = 4$				1	1	1	11	2 628		
$r = 5$					1	1	1	135		
$r = 6$						1	1	1	4 382	
$r = 7$							1	1	1	
$r = 8$								1	1	1
$r = 9$									1	1
$r = 10$										1

Table 6.4: Number of isomorphism classes of uniform oriented matroids

in [Bok93]) and completely coincide with the numbers obtained by our programs. The generation usually was considered together with the realizability problem, the problem whether an oriented matroid can be realized by coordinates in Euclidean space (see also

Section 0.1). For  $r = 3$ , the generation and classification of the uniform cases is due to Grünbaum [Grü67, Grü72] for  $n = 7$ , Goodman and Pollack [GP80a] for  $n = 8$ , Richter-Gebert [Ric88] and Gonzalez-Sprinberg and Laffaille [GSL89] for  $n = 9$ , finally Bokowski, Laffaille, and Richter-Gebert (unpublished) for  $n = 10$ ; for  $r = 4$  and  $n = 8$  the classification is due to Bokowski and Richter-Gebert [BRG90]. The realizability problem is attacked from two sides: (i) finding realizations (using randomly generated points, various insertion or perturbation techniques) and (ii) proving that no realization can exist (e.g., with final polynomials [RG92]). The general case still needs work in both directions: Finding coordinates has the additional difficulty that some realizable instances do not have rational solutions; on the other hand some of the earlier methods to detect non-realizability have to be generalized to the degenerate case. The numbers of non-realizable uniform isomorphism classes are shown in Table 6.5. The classification problem for the general case is solved for  $r = 3$  and  $n \leq 8$  due to Goodman and Pollack [GP80b] (all cases are realizable, which was a conjecture of Grünbaum [Grü72]).

$n =$	1	2	3	4	5	6	7	8	9	10
$r = 1$	0									
$r = 2$		0	0	0	0	0	0	0	0	0
$r = 3$			0	0	0	0	0	0	1	242
$r = 4$				0	0	0	0	24		
$r = 5$					0	0	0	0		
$r = 6$						0	0	0	1	
$r = 7$							0	0	0	242
$r = 8$								0	0	0
$r = 9$									0	0
$r = 10$										0

Table 6.5: Number of non-realizable isomorphism classes of uniform oriented matroids

In the uniform case there is a symmetry of the numbers of isomorphism classes (for given  $n$  there are as many uniform classes of rank  $r$  as of rank  $n - r$ ) which can be explained by duality arguments (uniform oriented matroids are simple and co-simple; see also Section 3.2). This symmetry implies  $|\text{IC}(10, 7)| = 312\,356$ ; we did not display this number in Table 6.4 as this is the only number not computed directly. The symmetry under dualization disappears when moving from uniform to general oriented matroids. The reason for this asymmetry is that dualization of oriented matroids does not preserve the property of being simple: it is possible that non-parallel elements become parallel, furthermore coloops will become loops (see Lemma 0.5.9); for details see Section 3.2.

Table 6.6 shows CPU times needed to compute the isomorphism classes of oriented matroids on a Sun Sparc Ultra-60 using one processor at 360 MHz. A '-' sign indicates that the run time is very short, and ' $\approx$ ' indicates an approximate value. In current implementations most of the time is spent to compute the representation of an oriented matroid as its maximal chirotope encoding (see comments at the end of the previous section).

For those cases where there is a significant amount of CPU time, Table 6.7 shows the

$n =$	1	2	3	4	5	6	7	8	9	10
$r = 1$	-									
$r = 2$		-	-	-	-	-	-	-	-	-
$r = 3$			-	-	-	-	3 sec	2.2 min	3.6 hours	$\approx 72$ days
$r = 4$				-	-	-	10 sec	4.1 hours		
$r = 5$					-	-	2 sec	48.3 min		
$r = 6$						-	-	26 sec	$\approx 10$ days	
$r = 7$							-	-	9.9 min	
$r = 8$								-	-	4.8 hours
$r = 9$									-	-
$r = 10$										-

Table 6.6: CPU time needed to compute isomorphism classes of oriented matroids

$n =$	7	8	9	10
$r = 3$	21	27	28	$\approx 65$
$r = 4$	49	80		
$r = 5$	80	481		
$r = 6$	-	520	$\approx 1\,699$	
$r = 7$	-	-	6\,527	
$r = 8$		-	-	106\,463

Table 6.7: Average CPU time needed to compute one isomorphism class (in milliseconds)

average time used for one isomorphism class. There is a tremendous increase as rank  $r$  increases, and a more moderate increase in the number of elements  $n$ . This can be explained by the computation of representatives which is significantly more difficult in higher rank (this is also the case for other choices of representatives which are indicated at the end of the previous section). This motivates to compute the classes of higher rank by dualization. The computation of the dual of an oriented matroid is easy when using basis orientations (see Lemma 0.9.8). For special cases ( $\text{IC}(n, r)$  with  $r \geq n - 2$ ) the enumeration of isomorphism classes becomes rather simple; e.g., for  $\text{IC}(n, n - 2)$  the CPU time is almost negligible compared to the direct primal approach as used for Tables 6.6 and 6.7. However, the dualization of a set of isomorphism classes is not straightforward in the general case (see Section 3.2 for more details about the dualization approach).

The memory usage of our generation method is small as there is no need to store many intermediate results. The memory usage on disk used to store the isomorphism classes is shown in Table 6.8. The isomorphism classes are stored by the chirotope encodings of the representative as defined in Section 6.2. For every class in  $\text{IC}(n, r)$  there are  $\binom{n}{r}$  signs to be stored, which are encoded using 2 bits for every sign. For the storage of the larger lists  $\text{IC}(n, r)$  (namely when  $n \geq 8$ ,  $r \geq 3$ , and  $n - r \geq 2$ ) an indirect format is used: for every non-coloop minor  $\mathcal{M} \setminus n$  an integer indicates the number of extensions from this minor, which makes it possible to store only the last  $\binom{n-1}{r-1}$  signs of every extension (the first  $\binom{n-1}{r}$  signs coincide with those of the minor); coloop extensions are not stored at all.

$n =$	1	2	3	4	5	6	7	8	9	10
$r = 1$	1									
$r = 2$		1	1	2	3	4	6	7	9	12
$r = 3$			1	2	10	85	1 252	26 248	3 246 932	857 316 999
$r = 4$				1	4	45	1 803	1 587 461		
$r = 5$					1	6	132	51 060		
$r = 6$						1	9	160	7 032 296	
$r = 7$							1	12	319	
$r = 8$								1	16	693
$r = 9$									1	20
$r = 10$										1

Table 6.8: Memory used to store isomorphism classes of oriented matroids (in bytes, where every byte has 8 bits)

## 6.6 Access to Catalog and Examples

This section presents part of the catalog of oriented matroids, namely the smallest sets of isomorphism classes given by their maximal chirotope encoding (see Section 6.2). The complete catalog can be accessed via the Internet on <http://www.om.math.ethz.ch>.

We consider first the special cases:

- For  $n < r$  or  $n > r = 1$ , all lists  $\text{IC}(n, r)$  are empty.
- For  $n = r \geq 1$ , all lists  $\text{IC}(n, r)$  contain exactly one isomorphism class, which is uniform and represented by one  $+$  sign (cf. Lemma 3.2.3).
- For  $r = 2$  there is exactly one class in  $\text{IC}(n, r)$  (see Corollary 1.4.4) which is represented by  $\binom{n}{2}$  signs which are all  $+$  (hence this unique class corresponds to a uniform oriented matroid).
- For  $n = r + 1$  there are exactly  $n - 2 = r - 1$  classes in  $\text{IC}(n, r)$  (see Lemma 3.2.4), where  $\text{IC}(n, r, c)$  is represented by  $\binom{n}{n-1} = n$  signs whose  $c - 1$  first signs are 0 and all the remaining signs are  $+$ .

In the following we give the listings of the smaller of the remaining cases.

Table 6.9 shows the listing of the 4 isomorphism classes in  $\text{IC}(5, 3)$ . These 4 classes are contained as non-coloop minors in  $\text{IC}(6, 3)$  (see Table 6.2) and as coloop minors in  $\text{IC}(6, 4)$  (see Table 6.10).

The 17 isomorphism classes in  $\text{IC}(6, 3)$  have been given in Table 6.2.

Table 6.10 shows the 12 isomorphism classes in  $\text{IC}(6, 4)$ .

	1	1	1	2	1	1	2	1	2	3
	2	2	3	3	2	3	3	4	4	4
c	3	4	4	4	5	5	5	5	5	5
1	+	+	+	+	+	+	+	+	+	+
2	0	+	+	+	+	+	+	+	+	+
3	0	+	+	+	+	+	+	0	+	+
4	0	0	0	0	+	+	+	+	+	+

Table 6.9: The 4 isomorphism classes in IC(5, 3)

	1	1	1	1	2	1	1	1	2	1	1	2	1	2	3
	2	2	2	3	3	2	2	3	3	2	3	3	4	4	4
	3	3	4	4	4	3	4	4	4	5	5	5	5	5	5
c	4	5	5	5	5	6	6	6	6	6	6	6	6	6	6
1	+	+	+	+	+	+	+	+	+	+	+	+	+	+	+
2	0	+	+	+	+	+	+	+	+	+	+	+	+	+	+
3	0	+	+	+	+	+	+	+	+	0	+	-	+	-	-
4	0	+	+	+	+	+	+	+	+	0	+	+	+	+	+
5	0	+	+	+	+	+	+	+	+	0	+	+	+	+	0
6	0	0	+	+	+	0	+	+	+	+	+	+	+	+	+
7	0	0	+	+	+	0	+	+	+	+	+	+	0	+	+
8	0	0	+	+	+	0	+	+	+	+	+	+	0	0	0
9	0	0	0	0	0	0	+	+	+	+	+	+	+	+	+
10	0	0	0	0	0	0	+	+	+	+	+	+	+	+	+
11	0	0	0	0	0	0	+	+	+	+	+	+	0	+	+
12	0	0	0	0	0	0	0	0	0	0	+	+	+	+	+

Table 6.10: The 12 isomorphism classes in IC(6, 4)



*I made me no more ado but took all their seven  
points in my target, thus.*

HENRY IV (I:2,4)

## Chapter 7

# Complete Listing of Point Configurations

### 7.1 Introduction

The generation of combinatorial types of geometric objects such as point configurations, polytopes, or hyperplane arrangements has long been an outstanding problem of combinatorial geometry. We consider in this chapter point configurations and polytopes, in the following Chapter 8 hyperplane arrangements.

A *point configuration* is a set of  $n$  points in the real Euclidean space  $\mathbb{R}^d$ . Its combinatorial type, called *order type*, is determined by the relative positions of the points, more formally by the set of all partitions of the  $n$  points by hyperplanes, where the points may be arbitrarily relabeled. A *polytope* is the convex hull of a point configuration. The combinatorial type of a polytope is determined by its face lattice.

For the generation of these combinatorial types no direct method is known, and it appears to be necessary to use combinatorial abstractions as has been the case in previous investigations [GP83, Knu92, AAK01]; the abstractions used so far (such as allowable sequences of permutations or  $\lambda$ -functions) usually fall together with certain classes of oriented matroids. Although it is NP-hard to decide whether a given oriented matroid is realizable or not [Mnë88, Sho91], the known classifications [Grü67, Grü72, GP80a, Ric88, GSL89, BRG90] and the practical realization methods [RG92] let the approach using oriented matroids become a successful method for the generation of combinatorial types.

The former work concentrated on the special case of low dimensions (i.e.,  $d = 2$  or  $d = 3$ ) and non-degenerate configurations (e.g., no three points lie on a line) which corresponds to uniform oriented matroids. Our goal is to generate the entire list of all cases for small  $n$ , including degenerate cases in arbitrary dimension  $d$ . However, we will restrict ourselves to the generation of *abstract* combinatorial types and will not consider the realizability

problem here. Nevertheless, this complete generation of abstract order types offers a powerful data base for various investigations as we will show by an example.

## 7.2 Point Configurations and Acyclic Oriented Matroids

We explain in this section how combinatorial types of point configurations relate to oriented matroids. We will use the illustration by sphere arrangements as introduced in Section 0.1.

Consider a point configuration  $\mathcal{P} = \{v^1, \dots, v^n\}$  in  $\mathbb{R}^d$ . An oriented hyperplane  $H$  partitions  $\mathcal{P}$  into vertices on the  $-$  side of  $H$ , on the  $+$  side of  $H$ , and vertices contained in  $H$ . This defines a corresponding sign vector in  $\{-, +, 0\}^n$ , see Figure 7.1. The collection

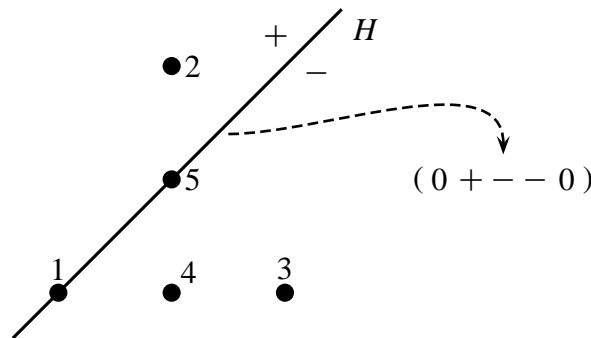

Figure 7.1: Sign vector defined by a hyperplane in a point configuration

of all possible sign vectors obtained by hyperplanes from  $\mathcal{P}$  defines the order type of  $\mathcal{P}$ . More formally, every oriented hyperplane  $H$  in  $\mathbb{R}^d$  can be described by a normal vector  $x \in \mathbb{R}^d$  which points to the  $+$  side of  $H$  and a translation given by  $x_{d+1} \in \mathbb{R}$  such that the sign vector  $X$  defined by  $\mathcal{P}$  and  $H$  has the components  $X_e = \text{sign}(\sum_{i=1}^d v_i^e x_i + x_{d+1})$  for  $e \in E$ . It is natural to introduce homogeneous coordinates by setting  $v_{d+1}^e := 1$  for  $e \in E$  as then  $\sum_{i=1}^d v_i^e x_i + x_{d+1}$  becomes the scalar product of  $v^e$  and  $x$  in  $\mathbb{R}^{d+1}$ . Furthermore, we can define  $A(\mathcal{P})$  to be the matrix of the  $n = |E|$  column vectors  $v^e \in \mathbb{R}^{d+1}$ ,  $e \in E$ . Similar as in Section 0.1, we define for  $A := A(\mathcal{P})$  the set of sign vectors  $\mathcal{F}(\mathcal{P}) := \{\text{sign}(A^T x) \mid x \in \mathbb{R}^{d+1}\}$ , and we know from Section 0.1 that  $\mathcal{F}(\mathcal{P})$  is the set of covectors of a realizable oriented matroid.

**7.2.1 Definition (Order Type of a Point Configuration)** Consider a point configuration  $\mathcal{P} = \{v^e \mid e \in E\}$  in  $\mathbb{R}^d$  on a finite ground set  $E$ . Define  $\mathcal{F}(\mathcal{P})$  as described above. The *order type of  $\mathcal{P}$*  is defined as the relabeling class  $\text{LC}(\mathcal{F}(\mathcal{P}))$  of the set  $\mathcal{F}(\mathcal{P})$ .

The above definition of an order type is exactly what we initially have described, except that the zero vector  $\mathbf{0}$  is always in  $\mathcal{F}(\mathcal{P})$ . The considerations from Section 0.1 imply that  $(E, \mathcal{F}(\mathcal{P}))$  is an oriented matroid. Furthermore, the sign vector  $(+ \dots +)$  is in  $\mathcal{F}(\mathcal{P})$ .



**7.2.2 Definition (Acyclic Oriented Matroid)** An oriented matroid  $\mathcal{M} = (E, \mathcal{F})$  such that there is  $X \in \mathcal{F}$  with  $X_e = +$  for all  $e \in E$  is called an *acyclic oriented matroid*.

**7.2.3 Lemma** Let  $\mathcal{P}$  be a point configuration on ground set  $E$ . Then  $(E, \mathcal{F}(\mathcal{P}))$  is an *acyclic oriented matroid*.

The following illustration may clarify that there is a one-to-one correspondence between order types and relabeling classes of realizable acyclic oriented matroids. We embed  $\mathcal{P}$  in  $\mathbb{R}^{d+1}$  by adding  $v_{d+1}^e = 1$  to every  $v^e$ . Geometrically, we can consider the extended vectors from  $\mathcal{P}$  as the normal vectors of a central arrangement of hyperplanes, and this intersected with the unit sphere  $S^d$  leads to a sphere arrangement as depicted in Figure 7.2. Every sphere in the arrangement has an orientation according to the corresponding normal

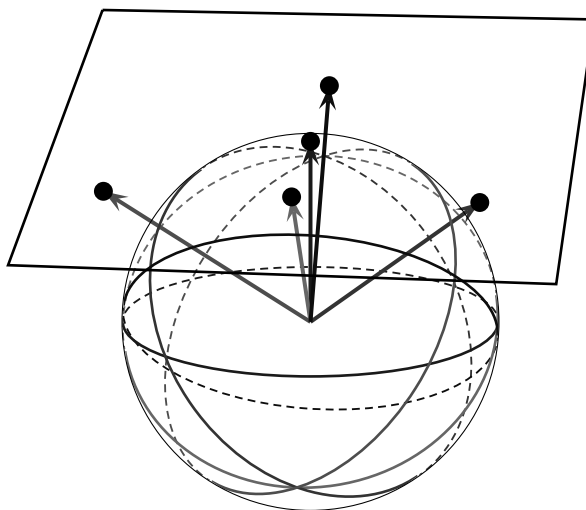

Figure 7.2: Point configuration and sphere arrangement

vector, and by this every cell in the sphere arrangement has a one-to-one relation to a sign vector in  $\mathcal{F}(\mathcal{P})$  as introduced above. Note that the cell containing  $v = (0, \dots, 0, 1)$  corresponds to the sign vector  $(+\dots+) \in \mathcal{F}(\mathcal{P})$ . The dimension of the oriented matroid defined by the sphere arrangement is  $d$  unless the points of  $\mathcal{P}$  are contained in a  $(d-1)$ -dimensional affine subspace.

On the other hand, if a realizable oriented matroid  $\mathcal{M}$  of dimension  $d$  is acyclic then there exists a representation by a  $d$ -dimensional sphere arrangement  $\mathcal{S}$  where some region corresponds to the tope  $(+\dots+)$ ; after an appropriate rotation of  $\mathcal{S}$  we can assume that this region contains the vector  $(0, \dots, 0, 1)$ . The normal vector of every sphere  $S_e \in \mathcal{S}$  which points to the  $+$  side of  $S_e$  can be scaled such that the  $(d+1)$ -coordinate is 1. The set of these scaled normal vectors defines a  $d$ -dimensional point configuration  $\mathcal{P}$  which is embedded in the hyperplane of points having a  $(d+1)$ -coordinate equal to 1. The oriented matroid  $(E, \mathcal{F}(\mathcal{P}))$  is the same as  $\mathcal{M}$  if the points are labeled accordingly.

If a point configuration is non-degenerate, i.e., the points are in general position, then the corresponding acyclic oriented matroid is uniform, and vice versa.

**7.2.4 Definition (Abstract Order Type)** We call the relabeling class of an acyclic oriented matroid an *abstract order type*. We call the relabeling class of a uniform acyclic oriented matroid a *non-degenerate abstract order type*.

### 7.3 Generation of Abstract Order Types

We will generate abstract order types, i.e., relabeling classes of acyclic oriented matroids, using the catalog of oriented matroids which has been presented in Chapter 6. For this consider  $n$  and  $d$  and, observing the relation of dimension and rank (cf. Definition 0.4.5), the complete list  $\text{IC}(n, d + 1)$  of all oriented matroids of  $n$  elements and rank  $d + 1$  up to isomorphism, i.e., up to reorientation and relabeling, as defined in Chapter 6.

Using the model of above we may think of  $\text{IC}(n, d + 1)$  as a list containing all types of unlabeled and unoriented topological sphere arrangements with  $n$  spheres on  $S^d$ . Abstract order types have the special property that some cell in the oriented sphere arrangement corresponds to the sign vector  $(+ \cdots +)$ . Consider any oriented sphere arrangement  $\mathcal{S}$  in  $\text{IC}(n, d + 1)$ , in  $\mathcal{S}$  some cell  $c$  of maximal dimension and its corresponding sign vector  $X(c)$ : A reorientation of  $\mathcal{S}$  according to  $X(c)$  will let  $c$  correspond to  $(+ \cdots +)$ . Hence the list of all sign vectors corresponding to cells of maximal dimension in  $\mathcal{S}$ , which is the set of topes of the oriented matroid, is sufficient to find all abstract order types isomorphic to  $\mathcal{S}$ .

In terms of oriented matroids, the algorithm is the following:

- Set  $r := d + 1$ .
- For every class  $\text{IC}(n, r, c)$  in  $\text{IC}(n, r)$  do:
  - Let  $\mathcal{M}$  be the representative of  $\text{IC}(n, r, c)$ , given by its encoding  $\chi(\mathcal{M})$ .
  - Compute the set of cocircuits  $\mathcal{D}$  from  $\chi(\mathcal{M})$  (see Proposition 0.9.7).
  - Compute from  $\mathcal{D}$  the set of topes  $\mathcal{T}$  using algorithm TOPESFROMCOCIRCUITS (see Pseudo-Code 1.5).
  - For every tope  $X \in \mathcal{T}$  compute the reorientation of  $\mathcal{D}$  according to  $X$  and its lexicographically maximal chirotope encoding w.r.t. relabeling (cf. Definition 6.2.1).
  - Remove multiple entries in the list of maximal encodings of reorientations, and output the resulting list.

Note that every abstract order type belongs to a unique isomorphism class of oriented matroids, hence every abstract order type is generated exactly once.

Tables 7.1 shows the numbers of abstract order types obtained by computations. Note that there are considerably fewer *non-degenerate* abstract order types, i.e., abstract order types corresponding to uniform oriented matroids (see Table 7.2).

$n =$	2	3	4	5	6	7	8	9	10
$d = 1$	1	1	1	1	1	1	1	1	1
$d = 2$		1	3	11	93	2 121	122 508	15 296 266	
$d = 3$			1	5	55	5 083	10 775 236		
$d = 4$				1	8	204	505 336		
$d = 5$					1	11	705		
$d = 6$						1	15	2 293	
$d = 7$							1	19	
$d = 8$								1	24
$d = 9$									1

Table 7.1: Number of abstract order types

$n =$	2	3	4	5	6	7	8	9	10
$d = 1$	1	1	1	1	1	1	1	1	1
$d = 2$		1	2	3	16	135	3 315	158 830	
$d = 3$			1	2	4	246	160 020		
$d = 4$				1	3	8	11 174		
$d = 5$					1	3	11	938 513	
$d = 6$						1	4	22	
$d = 7$							1	4	33
$d = 8$								1	5
$d = 9$									1

Table 7.2: Number of non-degenerate abstract order types

As discussed in Section 6.5, not all oriented matroids are realizable. *Non-degenerate* abstract order types in  $\mathbb{R}^2$  have been generated recently also by Aichholzer, Aurenhammer, and Krasser [AAK01] for  $n \leq 10$ . Their numbers coincide with ours for  $n \leq 9$ ; the number for  $n = 10$  is 14 320 182. They also realized these non-degenerate abstract order types (using the known numbers of isomorphism classes of uniform oriented matroid as a stopping criterion); the numbers of non-realizable non-degenerate abstract order types are listed in Table 7.3.

$n =$	3	4	5	6	7	8	9	10
$d = 2$	0	0	0	0	0	0	13	10 635

Table 7.3: Number of non-realizable non-degenerate abstract order types of rank 3

We present in Figures 7.3 to 7.5 realizations of abstract order types for small instances in  $\mathbb{R}^2$ , i.e., for configurations of 3 to 6 points (here, all abstract order types can be realized). The trivial types of collinear points (i.e., all points on a line) correspond to combinatorial types in  $\mathbb{R}^1$  and are not counted in  $\mathbb{R}^2$ . We draw the point configurations in Figures 7.3 to 7.5 with some lines which may be helpful when reading the picture. The following rule

was used for drawing of lines:

1. draw all lines which contain three or more points from the point configuration;
2. determine the points on the boundary of the convex hull of the point configuration;
3. if there is a point in the interior of the convex hull, then draw all lines which contain (at least) two points from the boundary of the convex hull, otherwise only draw those lines which contain a facet of the convex hull;
4. remove all points on the boundary of the convex hull and repeat steps 2 to 4 for the remaining points (in general several times, which was not necessary here).

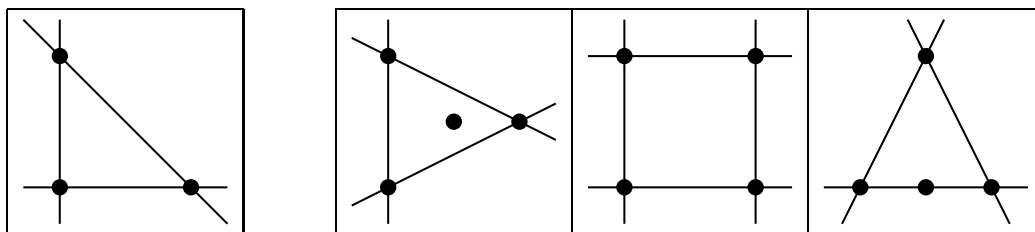

Figure 7.3: The order types with 3 and 4 non-collinear points in  $\mathbb{R}^2$

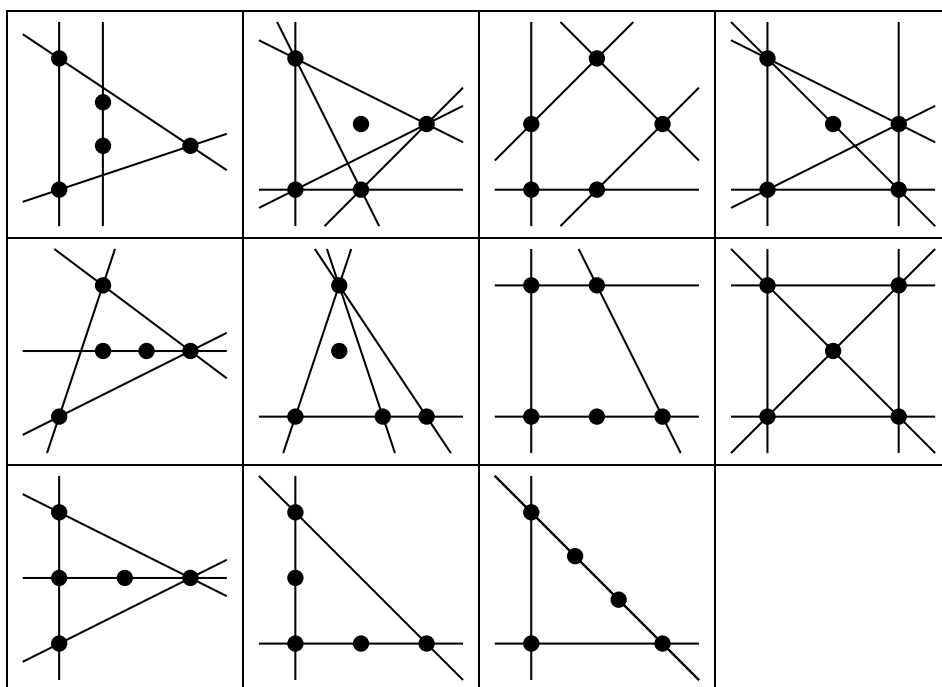

Figure 7.4: The 11 order types with 5 non-collinear points in  $\mathbb{R}^2$ ; only the first 3 are non-degenerate

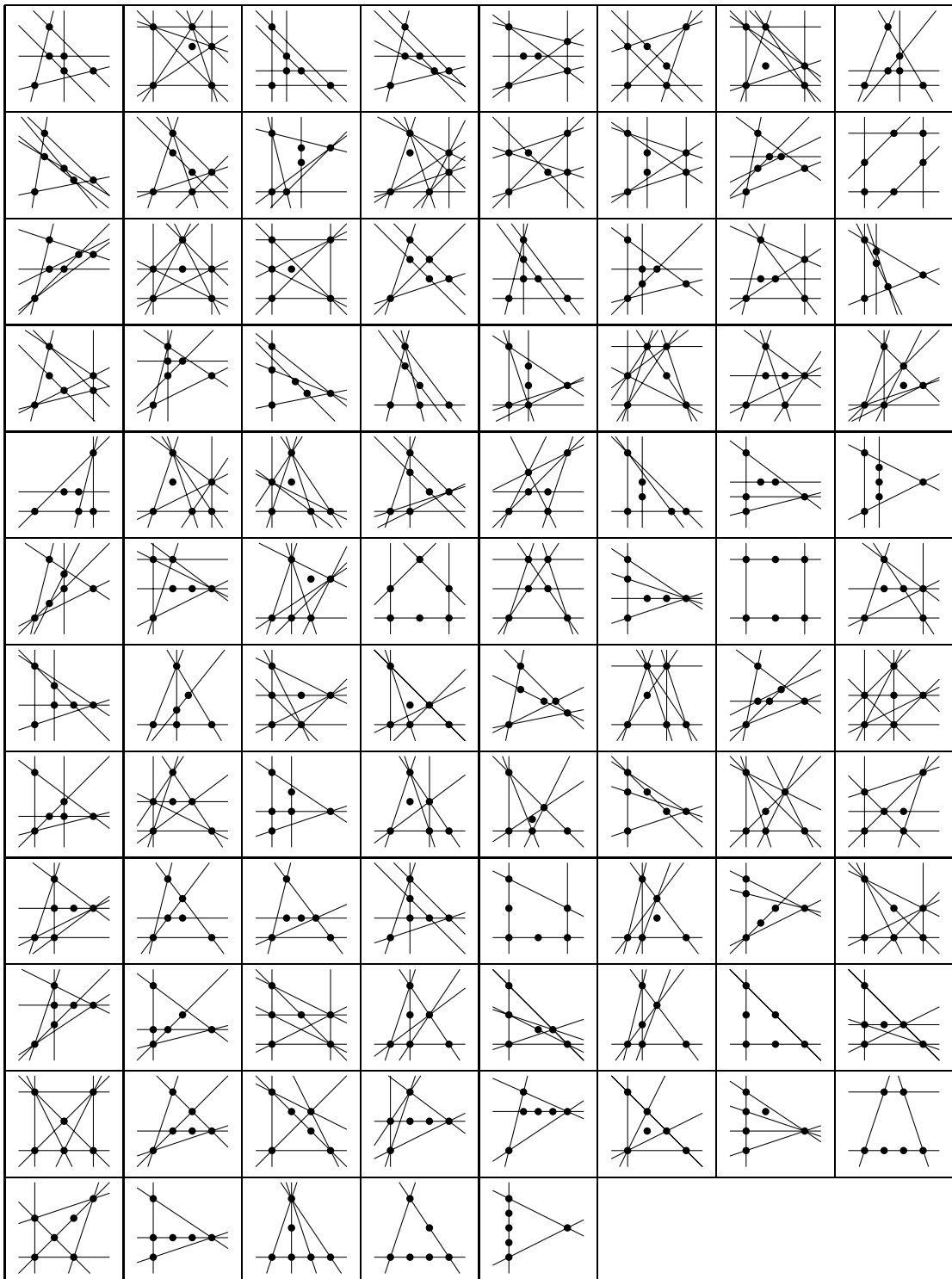

Figure 7.5: The 93 order types with 6 non-collinear points in  $\mathbb{R}^2$ ; only the first 16 are non-degenerate

## 7.4 Polytopes and Matroid Polytopes

We apply the listing of abstract order types for a corresponding listing of combinatorial types of polytopes.

Let  $\mathcal{P}$  be a  $d$ -dimensional point configuration, i.e.,  $\mathcal{P}$  is in  $\mathbb{R}^d$  and we assume that  $\mathcal{P}$  is not contained in an affine  $(d - 1)$ -dimensional subspace. The convex hull of  $\mathcal{P}$  defines a  $d$ -dimensional polytope. Every  $d$ -dimensional polytope can be defined this way. A point  $x \in \mathcal{P}$  is called a *vertex* (or an *extreme point*) of  $\mathcal{P}$  if it is not contained in the convex hull of the other points in  $\mathcal{P}$ . Equivalently, a point is a vertex if and only if there exists a hyperplane which separates the point from all the others. The convex hull of the vertices of  $\mathcal{P}$  defines the same polytope as  $\mathcal{P}$ , hence every polytope is defined by a point configuration whose points are all vertices. The corresponding abstraction to oriented matroids reads as follows:

**7.4.1 Definition (Extreme Point, Matroid Polytope)** Let  $\mathcal{M} = (E, \mathcal{F})$  be an acyclic oriented matroid. We call  $e \in E$  an *extreme point* if  $X \in \mathcal{F}$  such that  $X_e = -$  and  $X_f = +$  for all  $f \in E \setminus e$ . We call  $\mathcal{M}$  a *matroid polytope* if every element  $e \in E$  is an extreme point.

For more about matroid polytopes and the related theory see also Chapter 9 of [BLVS<sup>+</sup>99].

The list of abstract order types has been used to compute all relabeling classes of matroid polytopes. The procedure uses algorithm TOPESFROMCOCIRCUITS (see Pseudo-Code 1.5), as then the set of topes can be inspected: if for every  $e \in E$  there is a tope  $X$  such that  $X_e = -$  and  $X_f = +$  for all  $f \in E \setminus e$ , then we have found a matroid polytope. The numbers of matroid polytopes (up to relabeling) can be found in Table 7.4.

$n =$	3	4	5	6	7	8	9	10
$d = 2$	1	1	1	1	1	1	1	1
$d = 3$		1	2	12	361	250 591		
$d = 4$			1	4	62	109 786		
$d = 5$				1	6	302		
$d = 6$					1	9	1 239	
$d = 7$						1	12	
$d = 8$							1	16
$d = 9$								1

Table 7.4: Number of relabeling classes of matroid polytopes

The *combinatorial type* of a polytope is determined by its face lattice [Grü67, Zie95]. A face of a polytope corresponds to a non-negative (or non-positive) covector in the corresponding matroid polytope. By this we can identify two matroid polytopes which correspond to polytopes of same combinatorial type:

**7.4.2 Definition (Combinatorial Polytope Type)** Let  $\mathcal{M} = (E, \mathcal{F})$  be a matroid polytope. We call a covector  $X \in \mathcal{F}$  a *polytope face* of  $\mathcal{M}$  if  $X \geq 0$  (i.e.,  $X_e \in \{+, 0\}$  for all  $e \in E$ ). The *combinatorial polytope type* is determined by the set of polytope faces of  $\mathcal{M}$  up to relabeling: two matroid polytopes have *equal combinatorial polytope type* if they can be relabeled such that their sets of polytope faces are equal.

If we count the combinatorial polytope types of matroid polytopes, it turns out that the numbers coincide with the known numbers of combinatorial types of polytopes. In other words, every combinatorial polytope type of a matroid polytope in our list can be realized by coordinates for the vertices. Hence, if for every combinatorial type of polytopes coordinates are known, then our listings prove the completeness of the known classifications (which is an independent proof as our techniques are new). The classification of combinatorial types of polytopes can be found in [Grü67, KK95, AS84, AS85]). Table 7.5 shows the number of combinatorial polytope types of matroid polytopes which have been counted from our listings of matroid polytopes. These numbers are the same as the numbers of combinatorial types of  $d$ -dimensional polytopes with  $n$  vertices. Additional numbers are known for  $d = 3$  due to Steinitz' Theorem [SR34] which

$n =$	3	4	5	6	7	8	9	10
$d = 2$	1	1	1	1	1	1	1	1
$d = 3$		1	2	7	34	257		
$d = 4$			1	4	31	1294		
$d = 5$				1	6	116		
$d = 6$					1	9	379	
$d = 7$						1	12	
$d = 8$							1	16
$d = 9$								1

Table 7.5: Number of combinatorial polytope types of matroid polytopes

characterizes the graphs defined by vertices and edges of 3-dimensional polytopes as 3-connected planar graphs; there are 2606, 32300, 440564, 6384634, ... combinatorial types for  $n = 9, 10, 11, 12, \dots$  (see also [Grü67, KK95] and Sequence A000944 in [Slo01]). Furthermore, the number of combinatorial types of  $d$ -dimensional polytopes with  $d + 2$  vertices is  $\lfloor \frac{1}{4}d^2 \rfloor$  [Grü67], where  $\lfloor x \rfloor$  denotes the largest integer which is not larger than  $x$ . There is also a formula for polytopes with  $d + 3$  vertices stated by Lloyd in [Llo70]; it was doubted before whether this formula is completely correct (e.g., see page 172 in [Zie95]), and we found out that this is not the case: Lloyd's formula gives a value of 30 combinatorial types for  $d = 4$ , correct would be 31 (also for larger  $d$  the values are incorrect: 111 and 361 instead of 116 and 379 for  $d = 5$  and  $d = 6$ , respectively).

A  $d$ -dimensional polytope is called *simplicial* if all its  $(d - 1)$ -dimensional faces are  $(d - 1)$ -dimensional simplices, which are  $(d - 1)$ -dimensional polytopes with  $d$  vertices in general position. Correspondingly, we call a matroid polytope  $\mathcal{M} = (E, \mathcal{F})$  *simplicial* if each non-negative cocircuit  $X \in \mathcal{D}$  has  $d$  elements in  $X^0$ , in other words every polytope face  $X \geq 0$  of  $\mathcal{M}$  with  $\dim_{\mathcal{M}}(X^0) = d$  satisfies  $|X^0| = d$ . Note that this is not the same

as uniformity of  $\mathcal{M}$ . Among the numerous investigations on simplicial polytopes there are also studies w.r.t. the combinatorial types. We computed the number of combinatorial polytope types of simplicial matroid polytopes which is shown in Table 7.6. For the

$n =$	3	4	5	6	7	8	9	10
$d = 2$	1	1	1	1	1	1	1	1
$d = 3$		1	1	2	5	14		
$d = 4$			1	2	5	37		
$d = 5$				1	2	8		
$d = 6$					1	3	18	
$d = 7$						1	3	
$d = 8$							1	4
$d = 9$								1

Table 7.6: Number of combinatorial polytope types of simplicial matroid polytopes

classification of combinatorial types of simplicial polytopes see [Grü67, KK95]. More numbers than presented in Table 7.6 are known for  $d = 3$ , where the numbers are 50, 233, 1249, 7595, ... for  $n = 9, 10, 11, 12 \dots$  (see also Sequence A000109 in [Slo01]), and for  $d = 4$  and  $n = 9$ , where the number of combinatorial types is 1142 [ABS80], which has been obtained by classification of simplicial 3-spheres into polytopal and non-polytopal spheres and where a non-realizability argument coming from the theory of oriented matroids played an important role. In addition, it is known for  $n = d + 2$  that there are  $\lfloor \frac{1}{2}d \rfloor$  simplicial types [Grü67], and there is also a formula for  $n = d + 3$  (Perles in [Grü67], see also Sequence A000943 in [Slo01]), which gives 29 for  $n = 10$  and  $d = 7$ .

We suggest that the generation of oriented matroids may lead to more results concerning the combinatorial types of polytopes, especially when specialized generation methods restrict to matroid polytopes only. It is important to note that our results on the classification of general polytopes are based on the generation of general oriented matroids, including non-uniform ones. It may be an interesting future project to investigate the potential of (specialized) generation methods in connection with known techniques (e.g., Gale transforms [Grü67, BLVS<sup>+</sup>99]) used for classifications so far.

## 7.5 A Conjecture Related to the Sylvester-Gallai Theorem

We discuss in this section a conjecture of da Silva and Fukuda (Conjecture 4.2 in [dSF98]) which is related to the well-known Sylvester-Gallai Theorem for point configurations. Our complete listing of abstract order types will decide the conjecture partially.

We introduce first some notions which are used in the following. Consider a point configuration  $\mathcal{P} = \{x^1, \dots, x^n\}$  in the Euclidean plane  $\mathbb{R}^2$ . We assume for the following that the points in  $\mathcal{P}$  are *non-collinear*, i.e., there is no line which contains all points in  $\mathcal{P}$ . We



call a line in  $\mathbb{R}^2$  an *elementary line* if it contains exactly two points of  $\mathcal{P}$ . A *non-Radon partition* of  $\mathcal{P}$  is a partition of  $\mathcal{P}$  into three disjoint subsets  $\mathcal{P}^-$ ,  $\mathcal{P}^+$ ,  $\mathcal{P}^0$  such that there exist an oriented line  $s$  for which  $\mathcal{P}^-$  is the set of point in  $\mathcal{P}$  on the  $-$  side of  $s$ ,  $\mathcal{P}^+$  the set of points on the  $+$  side of  $s$ , and  $\mathcal{P}^0$  the set of points in  $\mathcal{P}$  on  $s$ . A *maximal non-Radon partition* of  $\mathcal{P}$  is a non-Radon partition with  $\mathcal{P}^0 = \emptyset$ , i.e., the separating line  $s$  does not contain any point from  $\mathcal{P}$ . A maximal non-Radon partition of  $\mathcal{P}$  is called *balanced* if  $||\mathcal{P}^-| - |\mathcal{P}^+|| \leq 1$ .

The Sylvester-Gallai Theorem states that in every configuration of non-collinear points in  $\mathbb{R}^2$  there exists an elementary line.

**7.5.1 Conjecture (da Silva and Fukuda [dSF98])** *Let  $\mathcal{P}$  be a configuration of non-collinear points in  $\mathbb{R}^2$ . For every balanced, maximal non-Radon partition  $\{\mathcal{P}^-, \mathcal{P}^+, \mathcal{P}^0\}$  of  $\mathcal{P}$  there exist  $x^- \in \mathcal{P}^-$ ,  $x^+ \in \mathcal{P}^+$  which are contained in an elementary line.*

An elementary line containing  $x^- \in \mathcal{P}^-$  and  $x^+ \in \mathcal{P}^+$  is also called a *crossing elementary line*.

Some weaker versions of Conjecture 7.5.1 have been proved by Pach and Pinchasi [PP00].

Let us translate the above notions into the language of oriented matroids, and without loss of generality we restrict for the following to simple oriented matroids. Configurations of non-collinear points in  $\mathbb{R}^2$  correspond to acyclic oriented matroids of rank 3, and non-Radon partitions to covectors. A maximal non-Radon partition is a tope, and a tope  $X$  corresponds to a balanced non-Radon partition if  $||X^-| - |X^+|| \leq 1$ ; we call such a tope *balanced*. This leads to the following oriented matroid version of the above conjecture:

**7.5.2 Conjecture (Oriented Matroid Version of da Silva-Fukuda Conjecture)** *Let  $\mathcal{M} = (E, \mathcal{F})$  be a simple acyclic oriented matroid of rank 3. For every balanced tope  $X$  of  $\mathcal{M}$  there is a pair  $\{e, f\} \in E$  of elements such that  $X_e = -X_f \neq 0$  and  $\text{span}_{\mathcal{M}}(\{e, f\}) = \{e, f\}$  or, equivalently, there exists a cocircuit  $Y \in \mathcal{F}$  with  $Y^0 = \{e, f\}$ .*

Conjecture 7.5.2 was tested for  $n \leq 9$  against the complete list of abstract order types, i.e., relabeling classes of acyclic oriented matroids; for  $n = 10$  the conjecture has been tested based on the list of isomorphism classes of oriented matroids. The result of these tests is the following:

**7.5.3 Proposition** *Conjecture 7.5.2 is valid for  $|E| \leq 8$  and  $|E| = 10$ . There is (up to relabeling) exactly one (simple) acyclic oriented matroid with  $|E| = 9$  elements which does not satisfy Conjecture 7.5.2; for all other 15 296 265 abstract order types of  $d = 2$  and  $|E| = 9$  Conjecture 7.5.2 holds.*

**7.5.4 Corollary** *Conjecture 7.5.1 is valid for  $|\mathcal{P}| \leq 8$  and  $|\mathcal{P}| = 10$ .*

The unique abstract order type in Proposition 7.5.3 which does not satisfy Conjecture 7.5.2 can be given by a set of 30 cocircuits as in Table 7.7, where a violating balanced tope is  $(- - + + + + - -)$ ; this tope is, up to negative, the only violating tope out of 52 topes.

0 0 0 0 - - - - +	0 0 0 0 + + + + -
0 - - - 0 0 + + -	0 + + + 0 0 - - +
0 - - - - 0 0 -	0 + + + + 0 0 +
0 - - - - - 0	0 + + + + + 0
- 0 + + 0 - 0 - +	+ 0 - - 0 + 0 + -
- 0 + + + 0 + - 0	+ 0 - - - 0 - + 0
- 0 + + + + 0 -	+ 0 - - - - 0 +
- - 0 + 0 - + - 0	+ + 0 - 0 + - + 0
- - 0 + + 0 + 0 -	+ + 0 - - 0 - 0 +
- - 0 + - - 0 - +	+ + 0 - + + 0 + -
- - - 0 0 - + 0 -	+ + + 0 0 + - 0 +
- - - 0 + 0 + + -	+ + + 0 - 0 - - +
- - - 0 - - 0 - 0	+ + + 0 + + 0 + 0
- + + + + 0 0 - +	+ - - - - 0 0 + -
- + + + + + 0 0	+ - - - - - 0 0

Table 7.7: Cocircuits of oriented matroid violating Conjecture 7.5.2

It was found that the above oriented matroid given in Table 7.7 is realizable; corresponding coordinates for the 9 points are shown in Table 7.8. Furthermore, a violating non-Radon partition is given by the line through the points  $(0.35, 1)$  and  $(0.6, -1)$ , i.e., the line is defined by  $8x + y = 3.8$  for  $\begin{pmatrix} x \\ y \end{pmatrix} \in \mathbb{R}^2$ . A picture of the counter-example can be found in Figure 7.6.

In order to prove that the coordinates of Table 7.8 are a correct counter-example, the reader has to verify the non-trivial collinearities shown in Table 7.9. Furthermore it has to be verified that the line  $8x + y = 3.8$  partitions the 9 points into  $\{1, 2, 8, 9\}$  and  $\{3, 4, 5, 6, 7\}$ . Finally note that there is no crossing elementary line: for each choice of  $r \in \{1, 2, 8, 9\}$  and  $s \in \{3, 4, 5, 6, 7\}$  there exists  $t \in \{1, \dots, 9\} \setminus \{r, s\}$  such that  $r, s, t$  are collinear. This leads to the following result:

**7.5.5 Proposition** *There exists a configuration of 9 points for which Conjecture 7.5.1 is not valid. Every configuration of 9 points for which Conjecture 7.5.1 is not valid has the same order type.*

Conjecture 7.5.1 remains open for  $n \geq 11$ , especially also for an even number of points.

It will be interesting to see more applications of the listing of abstract order types, and also to see to what extend specialized generation algorithms can be used for resolving geometric conjectures.

#	Algebraic (exact)		Numerical (approx.)	
	$x$	$y$	$x$	$y$
1	1	1	1	1
2	$\frac{1}{2}$	0	0.5	0
3	$\frac{1}{\sqrt{5}}$	$-1 + \frac{2}{\sqrt{5}}$	0.4472	-0.1056
4	$\frac{1}{3}$	$-\frac{1}{3}$	0.3333	-0.3333
5	$\frac{3}{2} - \frac{\sqrt{5}}{2}$	0	0.3820	0
6	$\frac{1}{\sqrt{5}}$	$1 - \frac{2}{\sqrt{5}}$	0.4472	0.1056
7	0	0	0	0
8	$\frac{1}{\sqrt{5}}$	$\frac{1}{\sqrt{5}}$	0.4472	0.4472
9	1	-1	1	-1

Table 7.8: Coordinates of point configuration violating Conjecture 7.5.1

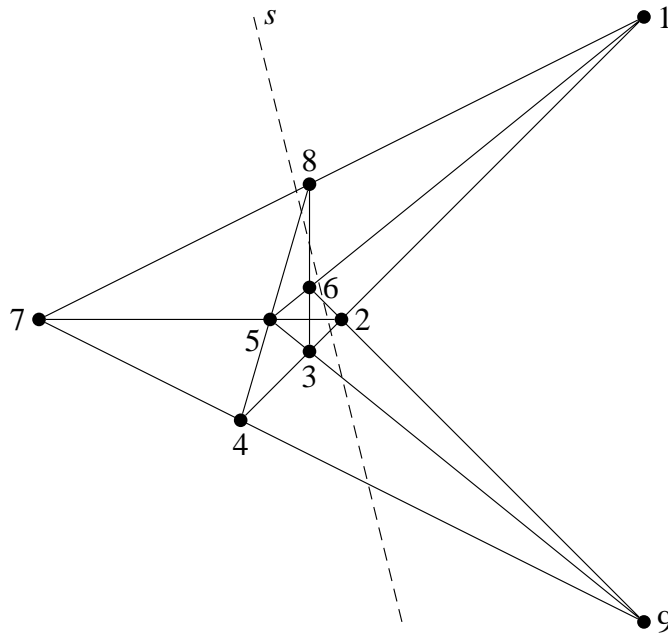

Figure 7.6: The counter-example with 9 points to Conjecture 7.5.1

Collinear Points	Line Containing Points
1234	$2x - y = 1$
156	$2x + (1 - \sqrt{5})y = 3 - \sqrt{5}$
178	$x - y = 0$
257	$y = 0$
269	$2x + y = 1$
359	$2x - (1 - \sqrt{5})y = 3 - \sqrt{5}$
368	$x = \frac{1}{\sqrt{5}}$
458	$2x - (7 - 3\sqrt{5})y = 3 - \sqrt{5}$
479	$x + y = 0$

Table 7.9: Non-trivial collinearities of point configuration violating Conjecture 7.5.1

... *much more general than these lines import.*

KING JOHN (4,3)

## Chapter 8

# Complete Listing of Hyperplane Arrangements

### 8.1 Introduction

This chapter introduces hyperplane arrangements in the Euclidean space. Similar to the previous chapter on point configurations, we discuss the relation to oriented matroids and generate complete listings of (abstract) combinatorial types of hyperplane arrangements.

A *hyperplane arrangement* is a set of  $n$  affine hyperplanes in  $\mathbb{R}^d$ . Its combinatorial type, which we call its *dissection type* (we introduce this notion in analogy to the notion of an order type of a point configuration), is determined by the relative positions of all cells. We give a more formal definition in the following section. Dissection types have primarily been studied for  $d = 2$ , where the hyperplanes become lines. For the generation of dissection types no direct method is known, instead generalizations and abstractions such as pseudoline arrangements and wiring diagrams have been used, and early it became clear that there is a strong relation to order types of point configurations. In fact, in the *projective case*, where point configurations and hyperplane arrangements in projective space  $\mathbb{P}^d$  are considered, order types and dissection types fall together and can be viewed as isomorphism classes of realizable oriented matroids: consider the illustration of realizable oriented matroids by sphere arrangements (as introduced in Section 0.1), where spheres define a projective hyperplane arrangement and their normal vectors a corresponding projective point configuration. For a “duality principle” in this sense see also [Goo80].

In the following we will consider the Euclidean case, where the relation of order types and dissection types is not obvious. Indeed, the (Euclidean) order types are generated from the “projective order types”, i.e., isomorphism classes of oriented matroids, by marking one element (hyperplane) as an infinity element; for  $d = 2$  this element can be interpreted as a “line at infinity”. By this, infinity elements play an analogous role for dissection types as  $(+ \dots +)$ -topes for order types: they mark the projective configuration such that its

embedding in a Euclidean space becomes sufficiently determined.

The realizability problem has been discussed in Chapters 6 and 7. Here we only add that, in contrast to point configurations, there is a topological abstraction of hyperplane arrangements which corresponds to general oriented matroids (due to the Topological Representation Theorem of Folkman and Lawrence [FL78]). There are also abstractions of point configurations in terms of pseudoconfigurations of points, but these do not cover all oriented matroids for  $d \geq 3$  [BLVS<sup>+</sup>99].

For former work on the generation and classification hyperplane arrangements we refer to [Rin56, Grü67, Grü72, GP80a, GP84]. Our goal will be to generate complete listings of abstract dissection types for small number  $n$  of hyperplanes, including degenerate cases in arbitrary dimension  $d$ . This complete generation of small hyperplane arrangements is, to our knowledge, the first such catalog, and we believe that it will be of interest to many researchers as a valuable source for testing conjectures and searching for specific properties.

## 8.2 Hyperplane Arrangements and Affine Oriented Matroids

This section discusses the relation of combinatorial types of hyperplane arrangements to oriented matroids. We will illustrate this relation by sphere arrangements which we have introduced in Section 0.1.

Consider a hyperplane arrangement  $\mathcal{Q} = \{h^1, \dots, h^n\}$  in  $\mathbb{R}^d$ . Every hyperplane  $h^e$  for  $e \in \{1, \dots, n\}$  can be described by a normal vector  $v^e \in \mathbb{R}^d$  and a translation given by  $v_{d+1}^e \in \mathbb{R}$  such that  $h^e$  is the set of points  $x \in \mathbb{R}^d$  for which  $\sum_{i=1}^d v_i^e x_i + v_{d+1}^e = 0$ . As we did for point configurations, we homogenize and introduce a coordinate  $x_{d+1}$  such that  $\sum_{i=1}^d v_i^e x_i + v_{d+1}^e$  becomes the scalar product of  $v^e$  and  $x$  in  $\mathbb{R}^{d+1}$  if we fix  $x_{d+1} = 1$ . Furthermore, we define  $A(\mathcal{Q})$  to be the matrix of the  $n + 1$  column vectors given by  $v^e \in \mathbb{R}^{d+1}$  for  $e \in E := \{1, \dots, n\} \cup \{g\}$ , where the vector  $v^g \in \mathbb{R}^{d+1}$  is defined by  $v_{d+1}^g := 1$  and  $v_i^g := 0$  otherwise;  $g \in E$  is a new index element which is called the *infinity* element. The vector  $v^g$  will be used to observe whether  $x_{d+1} = 1$  may be satisfied (note that by definition the scalar product of  $v^g$  and  $x \in \mathbb{R}^d$  is  $x_{d+1}$ ). Similar as in Section 0.1 we define for  $A := A(\mathcal{Q})$  the set of sign vectors  $\mathcal{F}(\mathcal{Q}) := \{\text{sign}(A^T x) \mid x \in \mathbb{R}^{d+1}\}$ , and we know from Section 0.1 that  $\mathcal{F}(\mathcal{Q})$  is the set of covectors of a realizable oriented matroid. Note that the reorientation class of  $\mathcal{F}(\mathcal{Q})$  is independent from the choice of  $v^e$  for  $h^e$ ,  $e \in E \setminus g$ .

**8.2.1 Definition (Dissection Type of a Hyperplane Arrangement)** Consider a hyperplane arrangement  $\mathcal{Q} = \{h^e \mid e \in E \setminus g\}$  in  $\mathbb{R}^d$  on a finite ground set  $E \setminus g$ . Define  $\mathcal{F}(\mathcal{Q})$  as described above, where  $g \in E$  denotes the infinity element. The *dissection type* of  $\mathcal{Q}$  is defined by a triple  $(E', \mathcal{F}', g')$  where  $\mathcal{F}'$  is a set of sign vectors on  $E'$  and  $g' \in E'$  such that there exists an isomorphism between  $\mathcal{F}(\mathcal{Q})$  and  $\mathcal{F}'$  which maps  $g$  to  $g'$ .

The following geometric reasoning may illustrate the relation of hyperplane arrangements

and oriented matroids further. Similar as for point configurations, a hyperplane arrangement  $\mathcal{Q} = \{h^1, \dots, h^n\}$ , where  $h^e$  is a hyperplane in  $\mathbb{R}^d$ , is embedded in  $\mathbb{R}^{d+1}$  by fixing the new coordinate to be 1. Every  $h^e$  determines a hyperplane  $H^e$  in  $\mathbb{R}^{d+1}$  which contains  $h^e$  and the origin  $0 \in \mathbb{R}^{d+1}$ . All  $H^e$  intersected with the unit sphere  $S^d$  lead to a sphere arrangement, where the orientations of the spheres are not given and may be chosen arbitrarily. This sphere arrangement corresponds to a projective hyperplane arrangement; for the given Euclidean hyperplane arrangement we have to add information how it was projected onto  $S^d$ , and we can do this by adding an extra sphere with normal vector  $(0, \dots, 0, 1)$  which is specially marked (see Figure 8.1). Hence oriented matroids which

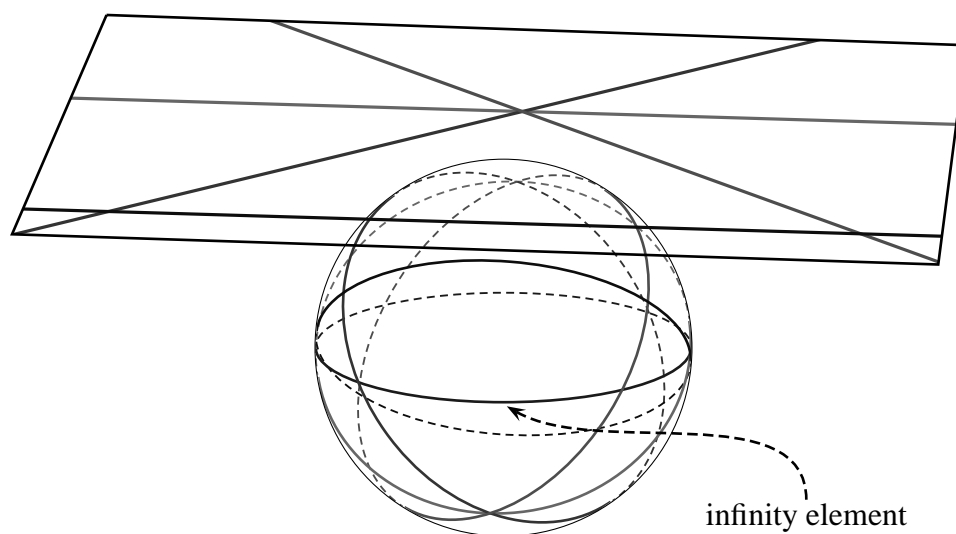

Figure 8.1: Hyperplane arrangement and sphere arrangement

are defined by hyperplane arrangements have the special property that one element  $g$ , the infinity element, is specially marked. The cells in the Euclidean hyperplane arrangement  $\mathcal{Q}$  correspond to covectors  $X$  with  $X_g = +$ . The dimension of the oriented matroid is  $d$ , unless all spheres (including the sphere of the infinity element) intersect in a common point, which corresponds to a point “at infinity” in the Euclidean space.

**8.2.2 Definition (Affine Oriented Matroid)** Let  $\mathcal{M} = (E, \mathcal{F})$  be an oriented matroid, and  $g \in E$ , where  $g$  is not a loop. Then we call the triple  $(E, \mathcal{F}, g)$  an *affine oriented matroid*.

If in a realizable oriented matroid  $\mathcal{M}$  of dimension  $d$  some non-loop element  $g$  is marked as an infinity element, then there exists a representation by a  $d$ -dimensional sphere arrangement  $\mathcal{S}$  where the sphere  $S_g$  has the normal vector  $(0, \dots, 0, 1)$ . The hyperplanes in  $\mathbb{R}^{d+1}$  which contain the spheres of  $\mathcal{S} \setminus g$  define a  $d$ -dimensional hyperplane arrangement by their intersection with the hyperplane of points having a  $(d+1)$ -coordinate equal to 1. This  $d$ -dimensional hyperplane arrangement determines  $\mathcal{M}$  up to reorientation and up to relabeling of the elements distinct from the infinity element.

**8.2.3 Definition (Abstract Dissection Type)** Two affine oriented matroids  $(E, \mathcal{F}, g)$ ,  $(E', \mathcal{F}', g')$  are called *affine isomorphic* if there exists an isomorphism between  $(E, \mathcal{F})$  and  $(E', \mathcal{F}')$  which identifies  $g$  and  $g'$ . We call the equivalence class of affine isomorphisms of an affine oriented matroid an *abstract dissection type*.

If a hyperplane arrangement is non-degenerate, i.e., the hyperplanes are in general position (which also means that there are no parallel hyperplanes), then the corresponding acyclic oriented matroid is uniform, and vice versa. We call the abstract dissection types corresponding to uniform oriented matroids *non-degenerate abstract dissection types*.

### 8.3 Generation of Abstract Dissection Types

We will generate abstract dissection types using the catalog of oriented matroids which has been presented in Chapter 6. Consider  $n$  and  $d$ , where  $n$  corresponds to the number of hyperplanes. As the relation discussed in the previous section introduces an infinity element, we have to consider the list  $\text{IC}(n+1, r)$  of all oriented matroids of rank  $r = d+1$  (cf. Definition 0.4.5) up to isomorphism in order to find all abstract dissection types of arrangements of  $n$  hyperplanes of dimension  $d$  (where the dimension is the one of the corresponding oriented matroid, so trivial extensions of lower-dimensional hyperplane arrangements to  $\mathbb{R}^d$  are not counted for the given  $d$  but for the corresponding lower dimension).

The complete list of abstract dissection types for  $n$  hyperplanes in  $\mathbb{R}^d$  is obtained from  $\text{IC}(n+1, d+1)$  by marking infinity elements in all possible ways and by identifying affine isomorphic types. For every class in  $\text{IC}(n+1, d+1)$  there are  $n+1$  choices for the infinity element.

In terms of oriented matroids, the algorithm is the following:

- Set  $r := d+1$ .
- For every class  $\text{IC}(n+1, r, c)$  in  $\text{IC}(n+1, r)$  do:
  - Let  $\mathcal{M}$  be the representative of  $\text{IC}(n+1, r, c)$ , given by its encoding  $\chi(\mathcal{M})$ .
  - For every choice of infinity element  $e \in E = \{1, \dots, n+1\}$  compute the lexicographically maximal chirotope encoding w.r.t. reorientation and relabeling such that  $e$  becomes the last element  $n+1$  (cf. Definition 6.2.1).
  - Remove multiple entries in the list of these maximal encodings, and output the resulting list.

Every abstract dissection type belongs to a unique isomorphism class of oriented matroids, hence every abstract dissection type is generated exactly once.

The numbers of abstract dissection types obtained by computations can be found in Table 8.1.



$n + 1 =$	2	3	4	5	6	7	8	9	10
$d = 1$	1	1	1	1	1	1	1	1	1
$d = 2$		1	3	8	46	790	37 829	4 134 939	
$d = 3$			1	5	27	1 063	1 434 219		
$d = 4$				1	7	71	44 956		
$d = 5$					1	9	156		
$d = 6$						1	11	325	
$d = 7$							1	13	646
$d = 8$								1	15
$d = 9$									1

Table 8.1: Number of abstract dissection types

For comparison, Table 8.2 shows corresponding numbers for *non-degenerate* dissection types. The known numbers (see [Rin56]) for  $d = 2$  and  $n \leq 7$  coincide with the numbers obtained by our programs.

$n + 1 =$	2	3	4	5	6	7	8	9	10
$d = 1$	1	1	1	1	1	1	1	1	1
$d = 2$		1	1	1	6	43	922	38 612	
$d = 3$			1	1	1	43	20 008		
$d = 4$				1	1	1	922		
$d = 5$					1	1	1	38 612	
$d = 6$						1	1	1	
$d = 7$							1	1	1
$d = 8$								1	1
$d = 9$									1

Table 8.2: Number of non-degenerate abstract dissection types

As discussed in Section 6.5, not all oriented matroids are realizable. It has been proved by Goodman and Pollack [GP80b] that every arrangement of at most eight pseudolines is stretchable, and any arrangement of nine is stretchable if some four lines meet in a point. For further comments on the realizability see in Chapters 6 and 7.

We present in Figures 8.2 to 8.4 realizations of abstract dissection types for small instances in  $\mathbb{R}^2$ , i.e., for arrangements of 2 to 5 hyperplanes (here, all abstract dissection types can be realized). Degenerate intersections (i.e., points where three or more lines intersect) are marked; lines without intersection in the drawing are parallel. The trivial types of all lines parallel correspond to combinatorial types in  $\mathbb{R}^1$  and are not counted in  $\mathbb{R}^2$ .

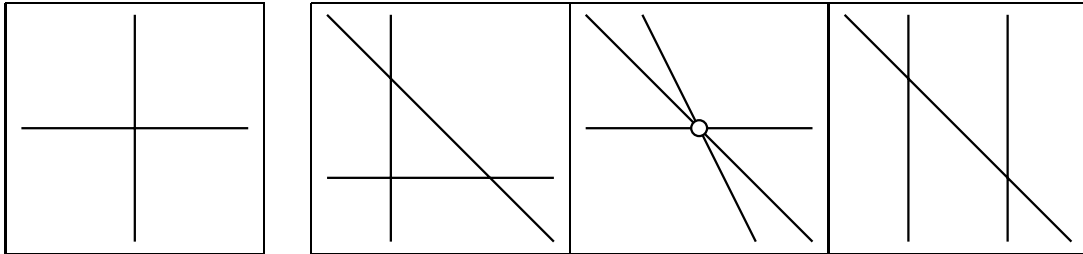

Figure 8.2: The dissection types with 2 and 3 non-parallel hyperplanes in  $\mathbb{R}^2$

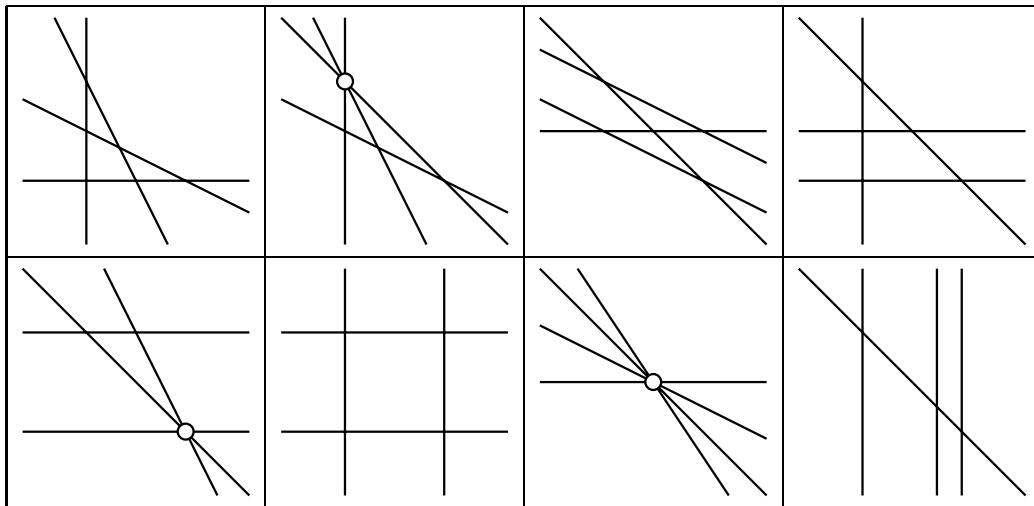

Figure 8.3: The 8 dissection types with 4 non-parallel hyperplanes in  $\mathbb{R}^2$ ; only the first is non-degenerate

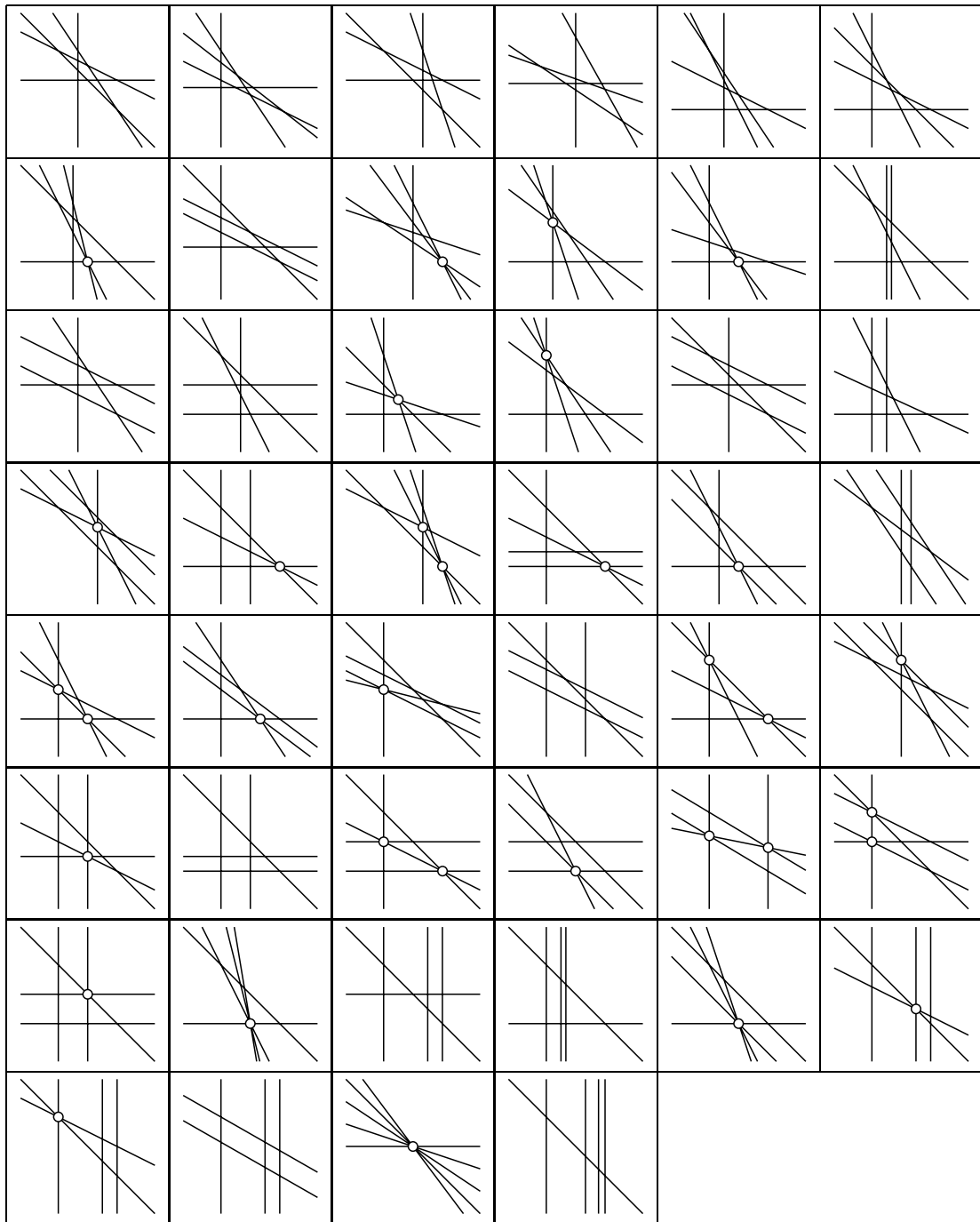

Figure 8.4: The 46 dissection types with 5 non-parallel hyperplanes in  $\mathbb{R}^2$ ; only the first 6 are non-degenerate



# Bibliography

- [AAK01] O. AICHHOLZER, F. AURENHAMMER, H. KRASSER: Enumerating order types for small point sets with applications, in: *Proc. 17th Ann. ACM Symp. Comput. Geometry*, Medford, MA, USA, pp. 11–18 (2001)
- [ABS80] A. ALTSHULER, J. BOKOWSKI, L. STEINBERG: The classification of simplicial 3-spheres with nine vertices into polytopes and nonpolytopes, *Discrete Math.* **31** (2), pp. 115–124 (1980)
- [AF96] D. AVIS, K. FUKUDA: Reverse search for enumeration, *Discrete Appl. Math.* **65** (1-3), pp. 21–46 (1996)
- [AK01] O. AICHHOLZER, H. KRASSER: The point set order type data base: a collection of applications and results, Manuscript, University of Technology, Graz (2001)
- [AS84] A. ALTSHULER, L. STEINBERG: Enumeration of the quasisimplicial 3-spheres and 4-polytopes with eight vertices, *Pacific J. Math.* **113** (2), pp. 269–288 (1984)
- [AS85] A. ALTSHULER, L. STEINBERG: The complete enumeration of the 4-polytopes and 3-spheres with eight vertices, *Pacific J. Math.* **117** (1), pp. 1–16 (1985)
- [Asc00] M. ASCHBACHER: *Finite group theory*, Cambridge University Press, Cambridge, ISBN 0-521-78145-0; 0-521-78675-4 (2000)
- [AVL62] G. M. ADEL'SON-VEL'SKIĬ, E. M. LANDIS: An algorithm for organization of information, *Dokl. Akad. Nauk SSSR* **146**, pp. 263–266 (1962)
- [BC87] W. BIENIA, R. CORDOVIL: An axiomatic of non-Radon partitions of oriented matroids, *European J. Combin.* **8** (1), pp. 1–4 (1987)
- [BEZ90] A. BJÖRNER, P. H. EDELMAN, G. M. ZIEGLER: Hyperplane arrangements with a lattice of regions, *Discrete Comput. Geom.* **5** (3), pp. 263–288 (1990)
- [BFF01] E. BABSON, L. FINSCHI, K. FUKUDA: Cocircuit graphs and efficient orientation reconstruction in oriented matroids, *Europ. J. Combinatorics* **22** (5), pp. 587–600 (2001)

- [BGdO00] J. BOKOWSKI, A. GUEDES DE OLIVEIRA: On the generation of oriented matroids, *Discrete Comput. Geom.* **24** (2-3), pp. 197–208 (2000)
- [Bla77] R. G. BLAND: A combinatorial abstraction of linear programming, *J. Combinatorial Theory Ser. B* **23** (1), pp. 33–57 (1977)
- [BLV78] R. G. BLAND, M. LAS VERGNAS: Orientability of matroids, *J. Combinatorial Theory Ser. B.* **24** (1), pp. 94–123 (1978)
- [BLV79] R. G. BLAND, M. LAS VERGNAS: Minty colorings and orientations of matroids, in: *Second International Conference on Combinatorial Mathematics (New York, 1978)*, New York Acad. Sci., New York, pp. 86–92 (1979)
- [BLVS<sup>+</sup>99] A. BJÖRNER, M. LAS VERGNAS, B. STURMFELS, N. WHITE, G. M. ZIEGLER: *Oriented matroids*, Cambridge University Press, Cambridge, 2nd edn., ISBN 0-521-77750-X (1999)
- [BML87] R. BLIND, P. MANI-LEVITSKA: Puzzles and polytope isomorphisms, *Aequationes Math.* **34** (2-3), pp. 287–297 (1987)
- [Bok93] J. BOKOWSKI: Oriented matroids, in: *Handbook of convex geometry, Vol. A, B*, North-Holland, Amsterdam, pp. 555–602 (1993)
- [BRG90] J. BOKOWSKI, J. RICHTER-GEBERT: On the classification of non-realizable oriented matroids, Preprint Nr. 1345, Technische Hochschule, Darmstadt (1990)
- [BS87] J. BOKOWSKI, B. STURMFELS: Polytopal and nonpolytopal spheres: an algorithmic approach, *Israel J. Math.* **57** (3), pp. 257–271 (1987)
- [BS89] J. BOKOWSKI, B. STURMFELS: *Computational synthetic geometry*, vol. 1355 of *Lecture Notes in Math.*, Springer-Verlag, Berlin, ISBN 3-540-50478-8 (1989)
- [CF93] R. CORDOVIL, K. FUKUDA: Oriented matroids and combinatorial manifolds, *European J. Combin.* **14** (1), pp. 9–15 (1993)
- [CFGdO00] R. CORDOVIL, K. FUKUDA, A. GUEDES DE OLIVEIRA: On the cocircuit graph of an oriented matroid, *Discrete Comput. Geom.* **24** (2-3), pp. 257–265 (2000)
- [Cor85a] R. CORDOVIL: A combinatorial perspective on the non-Radon partitions, *J. Combin. Theory Ser. A* **38** (1), pp. 38–47 (1985)
- [Cor85b] R. CORDOVIL: Erratum: “A combinatorial perspective on the non-Radon partitions”, *J. Combin. Theory Ser. A* **40** (1), pp. 194 (1985)
- [Cra65] H. H. CRAPO: Single-element extensions of matroids, *J. Res. Nat. Bur. Standards Sect. B* **69B**, pp. 55–65 (1965)

- [Djo73] D. Ž. DJOKOVIĆ: Distance-preserving subgraphs of hypercubes, *J. Combinatorial Theory Ser. B* **14**, pp. 263–267 (1973)
- [dS95] I. P. F. DA SILVA: Axioms for maximal vectors of an oriented matroid: a combinatorial characterization of the regions determined by an arrangement of pseudohyperplanes, *European J. Combin.* **16** (2), pp. 125–145 (1995)
- [dSF98] I. P. F. DA SILVA, K. FUKUDA: Isolating points by lines in the plane, *J. Geom.* **62** (1-2), pp. 48–65 (1998)
- [FF01] L. FINSCHI, K. FUKUDA: Generation of oriented matroids — a graph theoretical approach, To appear in *Discrete Comput. Geom.* (2001)
- [FFL99] L. FINSCHI, K. FUKUDA, H.-J. LÜTHI: Towards a unified framework for randomized pivoting algorithms in linear programming, in: *Operations Research Proceedings 1998 (Zurich)*, Springer, Berlin, pp. 113–122 (1999)
- [FH93] K. FUKUDA, K. HANDA: Antipodal graphs and oriented matroids, *Discrete Math.* **111** (1-3), pp. 245–256 (1993)
- [FL78] J. FOLKMAN, J. LAWRENCE: Oriented matroids, *J. Combin. Theory Ser. B* **25** (2), pp. 199–236 (1978)
- [FST91] K. FUKUDA, S. SAITO, A. TAMURA: Combinatorial face enumeration in arrangements and oriented matroids, *Discrete Appl. Math.* **31** (2), pp. 141–149 (1991)
- [Fuk82] K. FUKUDA: *Oriented matroid programming*, Ph.D. thesis, University of Waterloo (1982)
- [Fuk96] K. FUKUDA: Note on new complexity classes ENP, EP and CEP — an extension of the classes  $NP \cap co-NP$  and P, note in html, [http://www.ifor.math.ethz.ch/~fukuda/ENP\\_home/ENP\\_note.html](http://www.ifor.math.ethz.ch/~fukuda/ENP_home/ENP_note.html) (1996)
- [Fuk00a] K. FUKUDA: Frequently asked questions in polyhedral computation, <http://www.ifor.math.ethz.ch/~fukuda/polyfaq/polyfaq.html> (2000)
- [Fuk00b] K. FUKUDA: Oriented matroids and geometric computation, Lecture Notes, Swiss Federal Institute of Technology, Zurich, [ftp://ftp.ifor.math.ethz.ch/pub/fukuda/sources/ethcg\\_part123.ps.gz](ftp://ftp.ifor.math.ethz.ch/pub/fukuda/sources/ethcg_part123.ps.gz) (2000)
- [Fuk01] K. FUKUDA: Counting and listing, Lecture Notes, Swiss Federal Institute of Technology, Lausanne, <ftp://ftp.ifor.math.ethz.ch/pub/fukuda/reports/CountingAndListing.ps.gz> (2001)
- [Goo80] J. E. GOODMAN: Proof of a conjecture of Burr, Grünbaum, and Sloane, *Discrete Math.* **32** (1), pp. 27–35 (1980)

- [GP80a] J. E. GOODMAN, R. POLLACK: On the combinatorial classification of non-degenerate configurations in the plane, *J. Combin. Theory Ser. A* **29** (2), pp. 220–235 (1980)
- [GP80b] J. E. GOODMAN, R. POLLACK: Proof of Grünbaum’s conjecture on the stretchability of certain arrangements of pseudolines, *J. Combin. Theory Ser. A* **29** (3), pp. 385–390 (1980)
- [GP83] J. E. GOODMAN, R. POLLACK: Multidimensional sorting, *SIAM J. Comput.* **12** (3), pp. 484–507 (1983)
- [GP84] J. E. GOODMAN, R. POLLACK: Semispaces of configurations, cell complexes of arrangements, *J. Combin. Theory Ser. A* **37** (3), pp. 257–293 (1984)
- [Grü67] B. GRÜNBAUM: *Convex polytopes*, Interscience Publishers John Wiley & Sons, Inc., New York (1967)
- [Grü72] B. GRÜNBAUM: *Arrangements and spreads*, American Mathematical Society Providence, R.I. (1972)
- [GSL89] G. GONZALEZ-SPRINBERG, G. LAFFAILLE: Sur les arrangements simples de huit droites dans  $\mathbf{RP}^2$ , *C. R. Acad. Sci. Paris Sér. I Math.* **309** (6), pp. 341–344 (1989)
- [Han90] K. HANDA: A characterization of oriented matroids in terms of topes, *European J. Combin.* **11** (1), pp. 41–45 (1990)
- [Han93] K. HANDA: Topes of oriented matroids and related structures, *Publ. Res. Inst. Math. Sci.* **29** (2), pp. 235–266 (1993)
- [Jos00] M. JOSWIG: Reconstructing a non-simple polytope from its graph, in: *Polytopes—combinatorics and computation (Oberwolfach, 1997)*, Birkhäuser, Basel, pp. 167–176 (2000)
- [Kal88] G. KALAI: A simple way to tell a simple polytope from its graph, *J. Combin. Theory Ser. A* **49** (2), pp. 381–383 (1988)
- [KK95] V. KLEE, P. KLEINSCHMIDT: Convex polytopes and related complexes, in: *Handbook of combinatorics, Vol. 1, 2*, Elsevier, Amsterdam, pp. 875–917 (1995)
- [Knu73] D. E. KNUTH: *The art of computer programming. Volume 3*, Addison-Wesley Publishing Co., Reading, Mass.-London-Don Mills, Ont. (1973)
- [Knu92] D. E. KNUTH: *Axioms and hulls*, vol. 606 of *Lecture Notes in Computer Science*, Springer-Verlag, Berlin, ISBN 3-540-55611-7 (1992)
- [Law75] J. LAWRENCE: *Oriented matroids*, Ph.D. thesis, University of Washington, Seattle (1975)



- [Law82] J. LAWRENCE: Oriented matroids and multiply ordered sets, *Linear Algebra Appl.* **48**, pp. 1–12 (1982)
- [Llo70] E. K. LLOYD: The number of  $d$ -polytopes with  $d + 3$  vertices, *Mathematika* **17**, pp. 120–132 (1970)
- [LV75] M. LAS VERGNAS: Matroïdes orientables, *C. R. Acad. Sci. Paris Sér. A-B* **280**, pp. Ai, A61–A64 (1975)
- [LV78a] M. LAS VERGNAS: Bases in oriented matroids, *J. Combin. Theory Ser. B* **25** (3), pp. 283–289 (1978)
- [LV78b] M. LAS VERGNAS: Extensions ponctuelles d’une géométrie combinatoire orientée, in: *Problèmes combinatoires et théorie des graphes (Colloq. Internat. CNRS, Univ. Orsay, Orsay, 1976)*, CNRS, Paris, pp. 265–270 (1978)
- [LV80] M. LAS VERGNAS: Convexity in oriented matroids, *J. Combin. Theory Ser. B* **29** (2), pp. 231–243 (1980)
- [LV84] M. LAS VERGNAS: Oriented matroids as signed geometries real in corank 2, in: *Finite and infinite sets, Vol. I, II (Eger, 1981)*, North-Holland, Amsterdam, pp. 555–565 (1984)
- [Man82] A. MANDEL: *Topology of oriented matroid*, Ph.D. thesis, University of Waterloo (1982)
- [Mnë88] N. E. MNËV: The universality theorems on the classification problem of configuration varieties and convex polytopes varieties, in: *Topology and geometry—Rohlin Seminar*, Springer, Berlin, vol. 1346 of *Lecture Notes in Math.*, pp. 527–543 (1988)
- [Oxl92] J. G. OXLEY: *Matroid theory*, The Clarendon Press Oxford University Press, New York, ISBN 0-19-853563-5 (1992)
- [PP00] J. PACH, R. PINCHASI: Bichromatic lines with few points, *J. Combin. Theory Ser. A* **90** (2), pp. 326–335 (2000)
- [RG92] J. RICHTER-GEBERT: *On the realizability problem of combinatorial geometries decision methods*, Ph.D. thesis, TU Darmstadt (1992)
- [RG99] J. RICHTER-GEBERT: Testing orientability for matroids is NP-complete, *Adv. in Appl. Math.* **23** (1), pp. 78–90 (1999)
- [Ric88] J. RICHTER: *Kombinatorische Realisierbarkeitskriterien für orientierte Matroïde*, Master’s thesis, Technische Hochschule, Darmstadt, published in *Mitteilungen Mathem. Seminar Giessen*, Heft 194, Giessen 1989 (1988)
- [Rin56] G. RINGEL: Teilungen der Ebene durch Geraden oder topologische Geraden, *Math. Z.* **64**, pp. 79–102 (1956)

- [RW98] R. C. READ, R. J. WILSON: *An atlas of graphs*, The Clarendon Press Oxford University Press, New York, ISBN 0-19-853289-X (1998)
- [Sch86] A. SCHRIJVER: *Theory of linear and integer programming*, John Wiley & Sons Ltd., Chichester, ISBN 0-471-90854-1 (1986)
- [Sho91] P. W. SHOR: Stretchability of pseudolines is NP-hard, in: *Applied geometry and discrete mathematics: the Victor Klee Festschrift*, edited by P. Gritzmann, B. Sturmfels, Amer. Math. Soc., Providence, RI, vol. 4 of *DIMACS series in discrete mathematics and theoretical computer science*, pp. 531–554, ISBN 0-8218-6593-5 (1991)
- [Slo01] N. J. A. SLOANE: On-line encyclopedia of integer sequences, <http://www.research.att.com/~njas/sequences/index.html> (2001)
- [SR34] E. STEINITZ, H. RADEMACHER: *Vorlesungen über die Theorie der Polyeder unter Einschluss der Elemente der Topologie*, Springer-Verlag, Berlin (1934)
- [Stu88] B. STURMFELS: Some applications of affine Gale diagrams to polytopes with few vertices, *SIAM J. Discrete Math.* **1** (1), pp. 121–133 (1988)
- [Tom84] N. TOMIZAWA: Theory of acycloid and holometry, *RIMS Kōkyūroku* **534**, pp. 91–138 (1984)
- [Wel76] D. J. A. WELSH: *Matroid theory*, Academic Press [Harcourt Brace Jovanovich Publishers], London (1976)
- [Whi35] H. WHITNEY: On the abstract properties of linear dependence, *Amer. J. Math.* **57**, pp. 509–533 (1935)
- [Whi86] N. L. WHITE (ed.): *Theory of matroids*, Cambridge University Press, Cambridge, ISBN 0-521-30937-9 (1986)
- [Zie95] G. M. ZIEGLER: *Lectures on polytopes*, Springer-Verlag, New York, ISBN 0-387-94365-X (1995)

# Glossary of Notation

**Sets:** e.g.,  $R, S, E$

$ E $	cardinality of set
$S \subseteq E, S \subsetneq E$	subset, proper subset
$2^E$	power set (set of all subsets of $E$ )
$E \setminus S$	set difference
$R \cap S, R \cup S$	set intersection, set union
$E \cup e$ etc.	denotes $E \cup \{e\}$ etc. <b>21</b>

**Sign Vectors:** e.g.,  $X, Y \in \{-, +, 0\}^E, \mathcal{F} \subseteq \{-, +, 0\}^E$

$X_e$	component
$X_S, X \setminus S$	sign vector restricted to $S$ , restricted to $E \setminus S$ <b>21</b>
$X \setminus e$ etc.	denotes $X \setminus \{e\}$ etc. <b>21</b>
<b>0</b>	zero vector <b>21</b>
$-X$	negative (all signs reversed) <b>21</b>
$\overline{S}X$	signs in $S$ reversed <b>21</b>
$\underline{X}, X^0, X^+$ and $X^-$	support, zero support, positive and negative support <b>21</b>
$D(X, Y)$	separating (or disagreeing) elements <b>21</b>
$X \preceq Y, X \prec Y$	conformal relation <b>22</b>
$X \leq 0, X < 0$ etc.	signs are $-$ or $0$ , signs are $-$ etc. <b>33</b>
$X \circ Y$	composition <b>21</b>
$X * Y$	orthogonality <b>33</b>

**Matroids:** e.g.,  $M = (E, \mathcal{A})$

$\mathcal{A}$	flats (closed sets) <b>23</b>
$\mathcal{H}$	hyperplanes <b>27</b>
$\overline{S} = \text{span}_M(S)$	span of $S$ <b>24</b>
$\text{rank}_M(S), \text{rank}(M)$	rank of $S$ , rank of $M$ <b>26</b>
$\mathcal{B}$	bases <b>24</b>
$M \setminus R$	deletion minor <b>29</b>
$M/R$	contraction minor <b>29</b>

**Oriented Matroids:** e.g.,  $\mathcal{M} = (E, \mathcal{F})$ 

$\mathcal{F}$	covectors <b>21</b>
$\mathcal{D}$	cocircuits <b>37</b>
$\mathcal{T}$	topes <b>41</b>
$\chi$	chirotope <b>50</b>
$\underline{\mathcal{M}}$	underlying matroid <b>24</b>
$\text{rank}_{\mathcal{M}}(X)$ , $\text{rank}(\mathcal{M})$	rank of $X \in \mathcal{F}$ , rank of $\mathcal{M}$ <b>30</b>
$\text{dim}_{\mathcal{M}}(X)$ , $\text{dim}(\mathcal{M})$	dimension of $X \in \mathcal{F}$ , dimension of $\mathcal{M}$ <b>30</b>
$\hat{\mathcal{F}} = \mathcal{F} \cup \{\mathbf{1}\}$ , $\hat{\mathcal{F}}(\mathcal{M})$	set of faces, big face lattice <b>44</b>
$\mathcal{F}_i$	set of $i$ -faces (faces of dimension $i$ ) <b>45</b>
$f_i =  \mathcal{F}_i $	number of $i$ -faces <b>45</b>
$\mathcal{M} \setminus R$	deletion minor <b>29</b>
$\mathcal{M}/R$	contraction minor <b>29</b>

**Classes of Oriented Matroids:** e.g.,  $\text{IC}(\mathcal{M})$ 

$\text{LC}(\mathcal{M})$	relabeling class of $\mathcal{M}$ <b>57</b>
$\text{OC}(\mathcal{M})$	reorientation class of $\mathcal{M}$ <b>57</b>
$\text{IC}(\mathcal{M})$	isomorphism class of $\mathcal{M}$ <b>57</b>
$\text{IC}(n, r)$	set of all $\text{IC}(\mathcal{M})$ with $\mathcal{M}$ simple, $n =  E $ and rank $r$ <b>100</b>
$\text{IC}(n, r, c)$	class in $\text{IC}(n, r)$ at position $c$ <b>136</b>

**Graphs:** e.g.,  $G = (V(G), E(G))$ 

$v \in V(G)$	vertex <b>55</b>
$\{v, w\} \in E(G)$	edge <b>55</b>
$d_G(v, w)$	combinatorial distance in graph $G$ <b>55</b>
$\text{diam}(G)$	diameter <b>55</b>
$\text{Aut}(G)$	automorphism group <b>55</b>

# Subject Index

- abstract dissection type, 164
- acyclic oriented matroids, 149
- acycloid, 58
- acycloidal signature, 109
  - strong, 110
  - weak, 110
- affine oriented matroids, 163
- antipode label, 77
- antipodes
  - in cocircuit graphs, 77
  - in tope graphs, 60
- AP-label, 77
- AP-labeling problem, 77
- associating bijection
  - in cocircuit graphs, 76
  - in tope graphs, 56
- augmentation, 113
- automorphism of graphs, 55
  
- bases, 24
  - cardinality, 26
  - exchange property, 26
- basis orientations, 49
- big face lattice, 44
  - diamond property, 45
  
- central hyperplane arrangement, 16
- chirotopes, 50
- co-parallel, 96
- co-simple, 96
- cocircuit graphs, 75
  - antipodes, 77
  - localizations, 120
- cocircuits, 37
  - axioms, 38
  - determine covectors, 37
  - modular elimination, 39
  - strong elimination, 38
- coline cycles, 80
  
- colines, 27
- coloop, 31
- combinatorial polytope type, 155
- composition, 21
- conformal decomposition, 37
- conformal elimination, 22
- conformal relation, 19, 22
- contraction minors, 29
- covectors
  - axioms, 21
  - conformal elimination, 22
  - determined by cocircuits, 37
  - determined by topes, 42
  - weak elimination, 22
  
- deletion minors, 29
- diameter of a graph, 55
- diamond property, 45
- dimension
  - in oriented matroids, 30
- disagree, 21
- dissection type, 162
- distance in graphs, 55
- distance of coline cycles, 82
- dual, 33
  
- edge class, 60
- edges, 55
- element, 21
- encoding, 135
- extension, 100
- extreme point, 154
  
- i*-face, 45
- face lattice, 44
  - diamond property, 45
- facial relation, 19, 22
- flat axioms, 23
- fundamental cocircuit, 49

- graph, 55
  - automorphism, 55
  - cocircuit graph, 75
  - diameter, 55
  - distance, 55
  - isomorphism, 55
  - tope graph, 55
- graph label, 76
- ground set, 21
- hyperplane arrangements, 161
  - dissection type, 162
- hyperplanes, 27
- independent sets, 24
- isomorphism of graphs, 55
- isomorphism of sets of sign vectors, 57
- $L^1$ -system, 58
- label of a graph, 76
- linear, 17
- localizations
  - of cocircuit graphs, 120
  - of tope graphs, 108
  - weak localizations, 125
- loop, 31, 42
- M-label, 77
- M-labeling problem, 77
- matroid label, 77
- matroid polytope, 154
- matroids
  - bases, 24
  - flat axioms, 23
  - hyperplane axioms, 27
  - independent sets, 24
  - rank, 26
  - span, 24
  - underlying matroid, 24
  - uniform, 28
- maximal localization, 115
- minors
  - contraction, 29
  - deletion, 29
- modular, 39
- modular cocircuit elimination, 39
- negative, 21
- negative support, 21
- OM-label, 76
- OM-labeling problem, 77
- OMP, 46
- order type, 148
- ordered sets, 48
- oriented matroid label, 76
- oriented matroid program, 46
- oriented matroids
  - acyclic, 149
  - affine, 163
  - axioms
    - cocircuits, 38
    - covectors, 21
    - modular cocircuit elimination, 39
  - big face lattice, 44
  - chirotopes, 50
  - cocircuit axioms, 38
  - covector axioms, 21
  - defined by a matrix, 16
  - dimension, 30
  - extension, 100
  - face lattice, 44
  - generation problem, 95
  - isomorphism checking problem, 101
  - isomorphism class generation problem, 96
  - isomorphism class representation problem, 101
  - linear, 17
  - modular cocircuit elimination, 39
  - multiple extension reduction problem, 101
  - rank, 30
  - rank 0, 46
  - rank 1, 46
  - rank 2, 67
  - realizable, 17
  - single element extension, 100
  - single element extension problem, 101
  - topes, 41
  - uniform, 28
- orthogonality, 33
- parallel, 42

- parallel classes, 42
- point configurations, 147
  - order type, 148
- polytopes, 147, 154
  - combinatorial type, 155
- positive support, 21
- pseudosphere arrangement, 18
  
- rank
  - in face lattice, 44
  - in matroids, 26
  - in oriented matroids, 30
- realizable, 17
- relabeling, 57
- reorientation, 57
- reorientation property, 43
- representative, 135
  
- separable tope graphs, 63
- separate, 21
- shelling property, 43
- sign vector, 21
- signatures, 107
- simple, 57
- simplification, 57
- single element extension, 100
- span, 24
- sphere arrangement, 18
- strong acycloidal signature, 110
- strong cocircuit elimination, 38
- support, 21
  - negative support, 21
  - positive support, 21
  - zero support, 21
  
- tope graphs, 55
  - antipodes, 60
  - localizations, 108
  - separable, 63
- topes, 41
  - determine covectors, 42
- types of coline cycles, 122
  
- underlying matroid, 24
- uniform, 28
  
- vertex label, 76
- vertices of graph, 55
  
- vertices of point configuration, 154
  
- weak acycloidal signature, 110
- weak elimination, 22
- weak localizations, 125
  
- zero support, 21